

AquaCal®

HEATWAVE SUPERQUIET®

TropiCool
WATER CHILLER

Installation Manual

Five (Push) Button Display v2.xxx (HP11 control board), with embedded WiFi.

Important

Read this document before operating / installing this product

For additional product manuals and operation / installation procedures, please visit www.AquaCal.com



MODEL / SERIAL NUMBER

Table of Contents

Contacting AquaCal AutoPilot, Inc.	1
Safety	1
1 - Installation	5
1.1 Positioning Equipment	5
1.2 Clearances	6
1.3 Electrical	7
1.3.A Electrical Requirements	7
1.3.B Incoming Power Access Holes	9
1.3.C Access Panels	9
1.3.D Verifying Transformer Setting (Select Units)	10
1.3.E Schematic Location	11
1.4 Plumbing	12
1.4.A Plumbing Requirements	12
1.4.B Plumbing Diagrams	12
1.4.C Maintaining Ability to Winterize	16
1.4.D Water Connections to Heat Pump	16
1.4.E In-Line Chlorine Feeders	17
1.4.F Water Flow Rates	17
1.4.G Heat Pump Bypass Requirements	18
1.5 Programming	18
1.5.A Setting Date and Time	19
1.5.B Setting Date and Time Format	19
1.5.C Selecting Celsius or Fahrenheit	20
1.5.D Activate HEAT Mode, COOL Mode, AUTO Mode, or Deactivate Equipment	21
1.5.E Set a desired temperature (setpoint) for the Heat Pump to activate	22
1.5.F Using Shortcuts	23
1.6 Optional Installations	25
1.6.A Supplemental Options	25
1.7 Optional Programming	26
1.7.A Configure to use WiFi	26
1.7.B WiFi modes	28
1.7.C Configuring Groups	29
C.1 Create a Group	29
C.2 Edit a Group	31
C.3 Delete a Group	32
1.7.D Configuring Schedules	32
D.1 Create a Schedule	33
D.2 Edit a Schedule	34
D.3 Delete a Schedule	35
1.7.E Freeze Protection	36
1.7.F Setting Entry Code Option	38
1.7.G Disabling Entry Code Option	39
1.7.H Schedule and Program Modes	41

2 - Appendix	46
2.1 Service Mode	46
2.2 Service Help	47
2.3 Adjustments	48
2.3.A Adjusting Water Flow Using ΔT (Delta-T)	48
2.3.B Adjusting Water Pressure Switch (Select Units)	49
2.3.C Three-Phase Adjustment	50
2.4 Defaults	51
2.4.A Equipment Parameters	51
2.4.B Factory Reset	52
2.5 Supplemental	53
2.5.A Additional Options	53
2.5.B Available Accessories	53
2.5.C Cleaning Equipment After Installation	55
2.5.D Irrigation and Storm Run-Off	56
2.5.E Initial Cooling Recommendations	56
2.5.F Initial Heating Recommendations	56
2.5.G Saving Installer Settings to USB	57
2.5.H Use Installer Settings from USB	58
2.5.I Site Configuration Presets (Optional)	59
2.5.J Standards	61
2.5.K FCC Compliance	62
2.5.L Winterizing	62
2.6 System Information	64
2.6.A Dimensions	64
2.6.B Identifying Model Specifications	64
2.6.C Viewing System Information	65
2.6.D Viewing MAC Address (Configured WiFi Only)	66
2.6.E Weights	66
3 - Troubleshooting	67
3.1 Fault Codes	69
3.2 Issues and Resolutions	76

Contacting AquaCal AutoPilot, Inc.

For further assistance, please contact the distributor or installer of this product.

If unavailable, please contact AquaCal® for a partner in your area. To better assist you, please have the heat pump model and serial number available.

Product Information:	
Website	www.AquaCal.com
Phone	(1) 727-823-5642
Hours	8-5 pm, Eastern M-F

Service Information:	
Website	www.AquaCal.com/heat-pump-service/

SAFETY

- For personal safety, and to avoid damage to equipment, follow all safety instructions displayed on the equipment and within this manual. Repair and service of heat pump must be performed by an authorized service center.
- Warranties may be voided if the equipment has been improperly installed, maintained or serviced.
- If the issue persists, please contact the installing dealer for service.

SAFETY SIGNALS

Throughout this document, safety signals have been placed where particular attention is required.



Failure to heed the following will result in injury or death.



Failure to heed the following may result in injury or death.



Failure to heed the following may result in damage to equipment.

When installing and using your heat pump basic safety precautions must always be followed, including the following:

 DANGER

Failure to heed the following will result in injury or death.

- The heat pump utilizes high voltage and rotating equipment. Use caution when servicing.
- Prior to installing and servicing the equipment, ensure that power has been deactivated, and a lockout-tag out procedure has been performed.
- Follow all National Electric Codes (NEC) and / or State and Local guidelines.
- Heat Pump equipment must be installed according to manufacturer's instructions and specifications and must follow all National and / or State and Local installation guidelines. The manufacturer will not be liable in case of non-compliance with the installation standards that apply locally.
- Handling, installation, cleaning, servicing and / or disposal of the refrigerant can only be done by a person with the proper qualifications (EPA or equivalent licensing).
- For any action, other than simple maintenance operations by the user as described in this manual, the product should be maintained by a certified professional.
- Moving parts can cause severe injury or death. Do not touch the fan or the moving parts, and do not insert objects or your fingers close to the moving parts when the device is operating.
- Do not pull on hoses and / or connections to move the machine.
- Follow all instructions for installation and usage in this manual in order to prevent injury or death.

 WARNING

Failure to heed the following may result in injury or death.

- Installation and repairs must be performed by a qualified technician possessing the adequate technical skills (electricity, hydraulic, refrigeration) in order to undertake maintenance operations or repairs on the device.
- A qualified technician working on the device must use / wear personal protective equipment (safety goggles, protection gloves, etc.) in order to avoid risk of injury during work on the device.
- The Heat Pump contains refrigerant under pressure. Repairs to the refrigerant circuit must not be attempted by untrained and / or unqualified individuals. Service must be performed only by qualified HVAC technicians. Recover refrigerant before opening the system.
- Improper water chemistry can present a serious health hazard. To avoid possible hazards, maintain pool / spa water per standards as detailed in the product's operation manual.
- Sudden or prolonged immersion in water warmer than normal body temperature may cause a condition known as Hyperthermia and related injuries.
 - Hyperthermia occurs when the internal temperature of the body reaches a level several degrees higher than the normal body temperature of 98.6° F (37° C).
 - The symptoms of Hyperthermia include, but are not limited to, a failure to perceive heat, slurred speech or mumbling, slow, shallow breathing, weak pulse, clumsiness, drowsiness or low energy level, confusion, poor decision-making, lack of concern about personal welfare; progressive loss of consciousness resulting in danger of drowning.
 - The effects of Hyperthermia include failure of the nervous system, respiratory system and heart; failure to recognize the need to exit spa; unawareness of impending hazard; physical inability to exit the spa; progressive loss of consciousness resulting in danger of drowning.
 - Persons having an adverse medical history. or pregnant women, should consult a physician before immersing in a warm body of water. Children and the elderly should be supervised by a responsible adult.
 - When pregnant, soaking in warm water for long periods of time can harm the fetus.
 - The use of alcohol, drugs, or medication can greatly increase the risk of fatal Hyperthermia.
 - Exit immediately if uncomfortable, dizzy, or sleepy.

- Sudden or prolonged immersion in water colder than normal body temperature may cause a condition known as Hypothermia and related injuries.
 - Hypothermia occurs when the internal temperature of the body reaches a level several degrees below the normal body temperature of 98.6° F (37° C).
 - The symptoms of Hypothermia include, but are not limited to, shivering (although as hypothermia worsens, shivering stops), slurred speech or mumbling, slow, shallow breathing, weak pulse, clumsiness, drowsiness or low energy level, confusion, poor decision-making, lack of concern about personal welfare, unconsciousness, and bright red, cold skin (in infants).
 - The effects of Hypothermia include failure of the nervous system, respiratory system and heart; failure to recognize the need to exit spa or cold plunge; unawareness of impending hazard; fetal damage in pregnant women; physical inability to exit the spa or cold tub; progressive loss of consciousness resulting in danger of drowning.
 - Persons having an adverse medical history, or pregnant women, should consult a physician before immersing in a cold body of water. Children and the elderly should be supervised by a responsible adult.
 - When pregnant, soaking in cold water for long periods of time can harm the fetus.
 - The use of alcohol, drugs, or medication can greatly increase the risk of fatal Hypothermia.
 - Exit immediately if uncomfortable, dizzy, shivering, or sleepy.
- This appliance is not to be used by individuals (including children) with reduced physical, sensory, or mental capabilities, or lack of experience and knowledge, unless they have been given supervision or instruction by a person responsible for their safety.
- Children must be supervised and are not to play with the appliance.
- The information contained in this section is intended for use by qualified electricians familiar with electrical Service-industry safety standards and methods.
- Locate the equipment disconnect as near to the heat pump as possible. Always satisfy applicable codes and standards.
- Never mount power-disconnects directly to the heat pump.
- In sizing power wiring, be especially aware of up-sizing requirements necessary due to wiring distances. Always satisfy applicable codes and standards.
- AquaCal AutoPilot, Inc. heat pumps are designed to use copper conductors, only. Do not use aluminum wire.
- If multiple heat pumps are on-site, confirm that a multiple heat pump configuration has been utilized. This will prevent multiple heat pumps from attempting to start at the same time, causing an excessive power drop at start-up. This can be done with either an external sequencing controller, or if equipped, a heat pump option.
- If a fixed device does not have a power cord and plug, or any other means to disconnect from the power supply with separation of the contacts in all poles, enabling total disconnection in case of a category III electrical surge, the manual will specify that the disconnection means must be integrated into the fixed wiring, as per relevant wiring rules.
- An appropriate disconnection method, complying with all local and national requirements relating to category III electrical surges, and that disconnects all poles of the supply circuit, must be installed in the device's supply circuit. This disconnection method is not provided with the device and should be supplied by the installation technician.
- Prior to installation, ensure that:
 - The voltage indicated on the device's information plate matches the voltage of the power supply.
 - The power supply is suitable for operating the device and has a ground connection.
 - Any electrical plug (if necessary) is designed to properly fit the electrical outlet.
- Do not use an extension cord to connect the device; connect the device directly to a suitable power outlet.
- If a power cord is used and it becomes damaged, it must be replaced by a qualified individual.

NOTICE

Failure to heed the following may result in damage to equipment.

- Maintain proper water chemistry to avoid damage to the pump, filter, pool shell, etc.
- Water flow exceeding the maximum flow rate requires a bypass. Damage due to excessive water flow will void the warranty.
- Failure to protect equipment against corrosive conditions will adversely affect the life of the equipment and will void equipment warranty.
- The device is designed specifically for use in swimming pools and spas; it must not be used for purposes other than designed.

SAVE THESE INSTRUCTIONS

1 - Installation

⚠ DANGER

Failure to heed the following will result in injury or death.

- Deactivate power while routing wiring to control board.
- Heat Pump equipment must be installed within manufacturer specifications and must follow all National and/or State and Local installation guidelines.
- Follow all National Electric Codes (NEC) and/or State and Local guidelines.

⚠ WARNING

Failure to heed the following may result in injury or death.

- Installation of this equipment by anyone other than a qualified installer can result in a safety hazard.
- The information contained throughout the "Installation" section is intended for use by qualified installation technicians familiar with the swimming Pool/Spa safety standards.

NOTICE

Failure to heed the following may result in damage to equipment.

- Failure to protect equipment against corrosive conditions will adversely affect the life of the equipment and will void equipment warranty.
- Do not install equipment inside of a building.

IN THIS SECTION:

1.1 Positioning Equipment	5
1.2 Clearances	6
1.3 Electrical	7
1.4 Plumbing	12
1.5 Programming	18
1.6 Optional Installations	25
1.7 Optional Programming	26

1.1 Positioning Equipment

NOTICE

Failure to heed the following may result in damage to equipment.

- Do not install equipment inside of a building.

Outdoor Use Only

Do not install equipment inside of a room or building.

- Heat Pumps require unobstructed airflow for proper operation. Heat Pumps should never be installed indoors or in a location where airflow is restricted.
- If an indoor installation is being considered, the installer and dealer are strongly urged to contact the AquaCal Application Department, or a local Professional Engineer prior to proceeding.
- See "*Clearances*" on the next page.

Controlling Irrigation and Rainwater Runoff

- Irrigation water may damage heat pump components. Direct irrigation water away from the heat pump.
- The heat pump will withstand normal rainfall. Do not allow a roof slope to direct rainwater onto the heat pump. Have a gutter installed on the roof edge to direct this water away from the heat pump. Or install the heat pump in another location.

Planning for Condensation

The heat pump can produce a large amount of condensation. The amount of water depends on air temperature and humidity.

- Install the heat pump with enough height to allow for water drainage.
- Plan for water drainage as needed.

Mounting Pad Requirements

- The heat pump's base must be installed on a flat and level surface that completely supports the entire base.
- Build the heat pump pad out of concrete or other code-approved material.
- Confirm the pad can support the weight of the heat pump.
- Elevate the pad enough to allow for drainage.
- Make sure the pad is flat and level.
- Have the pad support the entire heat pump base in all directions.
- Do not install the heat pump on soil or grass.
- Do not allow the heat pump base to touch the building's foundation.
- Do not place the heat pump directly on a concrete floor. This can cause noise to be transmitted to an occupied space. If necessary install vibration dampers between the heat pump base and floor.
- Equipment pad must meet all requirements of authorities having code-related jurisdiction.
- Heat Pump equipment must be installed within manufacturer specifications and must follow all National and/or State and Local installation guidelines.

Anchoring to Pad

- Follow all applicable local, state, and national requirements regarding wind load anchoring.
- The shipping brackets used to secure the heat pump to the pallet are approved mounting (hurricane) brackets. They should be used to anchor the heat pump to the pad.
- If needed, contact AquaCal® to obtain anchoring kit information. Please have the heat pump model number and serial number when requesting support.

1.2 Clearances

- Proper air circulation is required for the heat pump to operate efficiently. View the diagram showing minimum clearances required for the proper operation of the heat pump.
- Avoid storing corrosive chemicals near the heat pump to minimize potential damage to the exterior of the heat pump.
- Avoid placing objects near or on top of the heat pump. This includes shrubbery and lawn furniture. These objects will reduce performance and efficiency and hinder maintenance access.
- **Heat pumps must not be installed indoors or in enclosed areas.**

(Overhead Clearance)

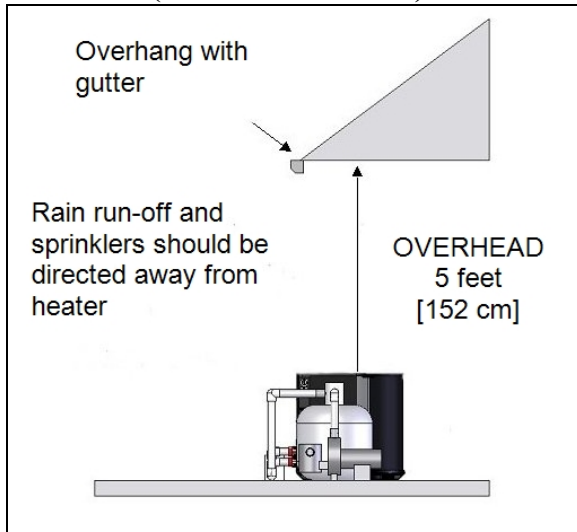

(Top View)

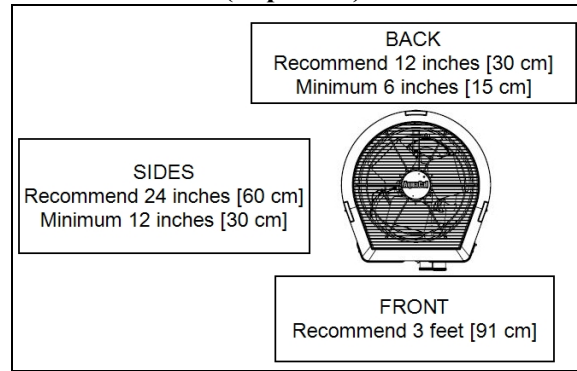

1.3 Electrical

⚠ DANGER

Failure to heed the following will result in injury or death.

- Deactivate power while routing wiring to control board.
- Heat Pump equipment must be installed within manufacturer specifications and must follow all National and/or State and Local installation guidelines.
- Follow all National Electric Codes (NEC) and/or State and Local guidelines.

⚠ WARNING

Failure to heed the following may result in injury or death.

- The information contained in this section is intended for use by qualified electricians familiar with electrical service-industry safety standards and methods.
- Locate the equipment disconnect as near to the heat pump as possible. Always satisfy applicable codes and standards.
- Never mount power-disconnects directly to the heat pump.
- In sizing power wiring, be especially aware of up-sizing requirements necessary due to wiring distances. Always satisfy applicable codes and standards.
- AquaCal® heat pumps are designed to use copper conductors, only. Do not use aluminum wire.

1.3.A Electrical Requirements

Grounding and Bonding

Follow local code requirements for proper grounding and bonding of heat pump equipment.

- A bonding lug has been provided on the heat pump.

Surge Suppression

The use of approved commercial surge protectors is strongly recommended.

Sizing the Electrical Service

Refer to equipment data plate for specific information required to size electrical service and over-current protection of the heat pump. Sizing is based on data plate information, wire size, wiring devices, and over-current protection per applicable local codes and standards.

PLEASE NOTE:

- *GFCI devices with a 5mA trip rating are known to experience nuisance trips when connected to HVAC equipment.*
- *Nuisance tripping does not indicate a problem with the unit and is not covered by the factory warranty.*

Minimum and Maximum Operating Voltage

The heat pump must operate within specified voltages.

NOTICE

Failure to heed the following may result in damage to equipment.

- Operating equipment under higher or lower voltage conditions may result in damage to your compressor, motors or other electrical components. This damage will not be covered by the product warranty.
- Measure site voltage. The site voltage **MUST** be measured under “FULL LOAD” conditions. Activate all equipment using the same electrical panel as the heat pump.
- If measured site voltage is outside listed ranges, immediately deactivate equipment until site conditions have been corrected.

Verifying Transformer Setting (Select Units)

Transformer voltage must be confirmed and set correctly depending on the measured voltage found on the site. Incorrect settings may cause heat pump damage.

Confirm transformer tap is set for the measured site voltage. If more than one voltage tap is shown, select the voltage nearest to the running site voltage.

Additional installation advice is available online. See "*Contacting AquaCal AutoPilot, Inc.*".

Equipment Rating	Minimum Site Voltage	Maximum Site Voltage
A Voltage (208 to 230 Volts) Single Phase 60 hertz	200 Volts	253 Volts
B Voltage with standard rotation monitor (208 to 230 Volts) Three Phase 60 hertz	200 Volts	253 Volts
B Voltage with ICM rotation monitor (208 to 230 Volts) Three Phase 60 hertz	200 Volts	251 Volts
G Voltage with standard rotation monitor (460 Volts) Three Phase 60 hertz	437 Volts	483 Volts
G Voltage with ICM rotation monitor (460 Volts) Three Phase 60 hertz	415 Volts	506 Volts

1.3.B Incoming Power Access Holes

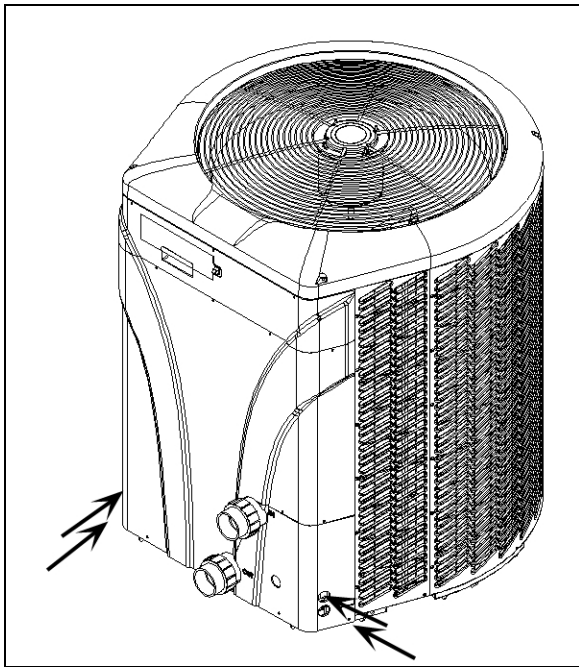

1.3.C Access Panels

⚠ DANGER

Failure to heed the following will result in injury or death.

- Deactivate power while routing wiring to control board.
- Heat Pump equipment must be installed within manufacturer specifications and must follow all National and/or State and Local installation guidelines.
- Follow all National Electric Codes (NEC) and/or State and Local guidelines.

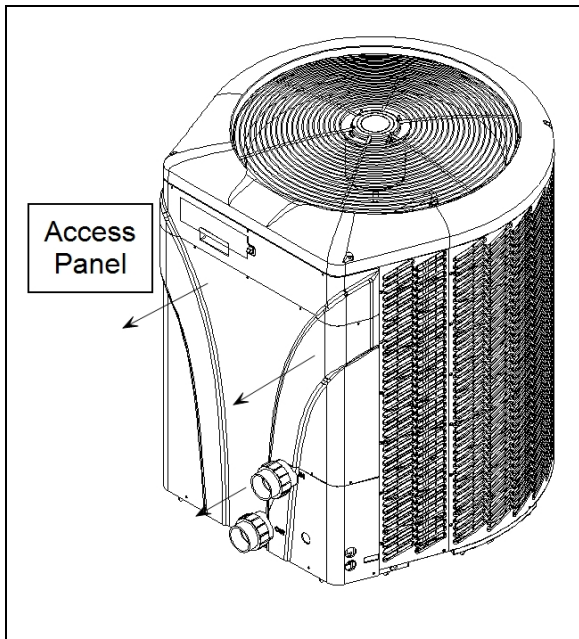

1.3.D Verifying Transformer Setting (Select Units)

Transformer voltage must be confirmed and set correctly depending on the measured voltage found on the site. Incorrect settings may cause heat pump damage. The following procedure will allow the installer to set the heat pump's transformer for the appropriate site voltage.

⚠ DANGER

Failure to heed the following will result in injury or death.

- Deactivate power while routing wiring to control board.
- Heat Pump equipment must be installed within manufacturer specifications and must follow all National and/or State and Local installation guidelines.
- Follow all National Electric Codes (NEC) and/or State and Local guidelines.

⚠ WARNING

Failure to heed the following may result in injury or death.

- The information contained in this section is intended for use by qualified technicians, familiar with electrical service-industry safety standards and methods.

Example of heat pump transformer (Varies between models)

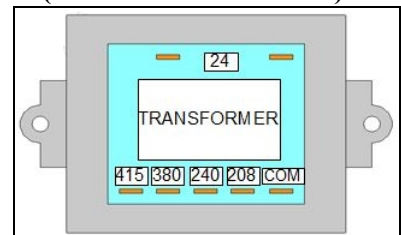

1. Turn heat pump on by adjusting the thermostat to call for heating or cooling. If more than one heat pump is on-site, turn them all on. Allow time for all heat pump compressors to activate.
2. Measure the running site voltage.
3. Confirm transformer tap is set for the measured site voltage. If more than one voltage tap is shown, select the voltage nearest to the running site voltage.

PLEASE NOTE -

- If more than one voltage is shown on the equipment's data plate, the factory default setting is usually the higher voltage on the transformer.
- As an example, a "208/230" voltage will be set to "240" from the factory.

1.3.E Schematic Location

Schematics are located on the inside of the electrical panel.

Schematics are located on the inside of the top panel.

1.4 Plumbing

1.4.A Plumbing Requirements

- The heat pump must receive water flow under worst-case conditions such as a fouled water filter.
- Failure to provide clean filtered water to the heat pump can void the product warranty.
- The heat pump is not intended to be installed on high pressure applications. Water flow exceeding maximum flow rates will negatively effect the total pool filtration performance and may damage the heat pump. This will not be covered under the equipment warranty. See "*Water Flow Rates*" on page 17. Install a bypass valve whenever water-flow may exceed the maximum rating.
 - For additional guidance testing water flow rates, please contact AquaCal®.

1.4.B Plumbing Diagrams

Plumbing diagrams are provided in this section as a planning guide to the sequence of equipment, valves, and fittings.

- The basic plumbing configurations for typical installations are shown.
- If the installation does not closely follow any of the supplied plumbing diagrams, AquaCal® Technical Support is available for installation advice and guidance.
- Confirm water provided to the heat pump is clean and filtered.

Heat Pump with water flows equal or less than the maximum listed flow rate

See "*Water Flow Rates*" on page 17.

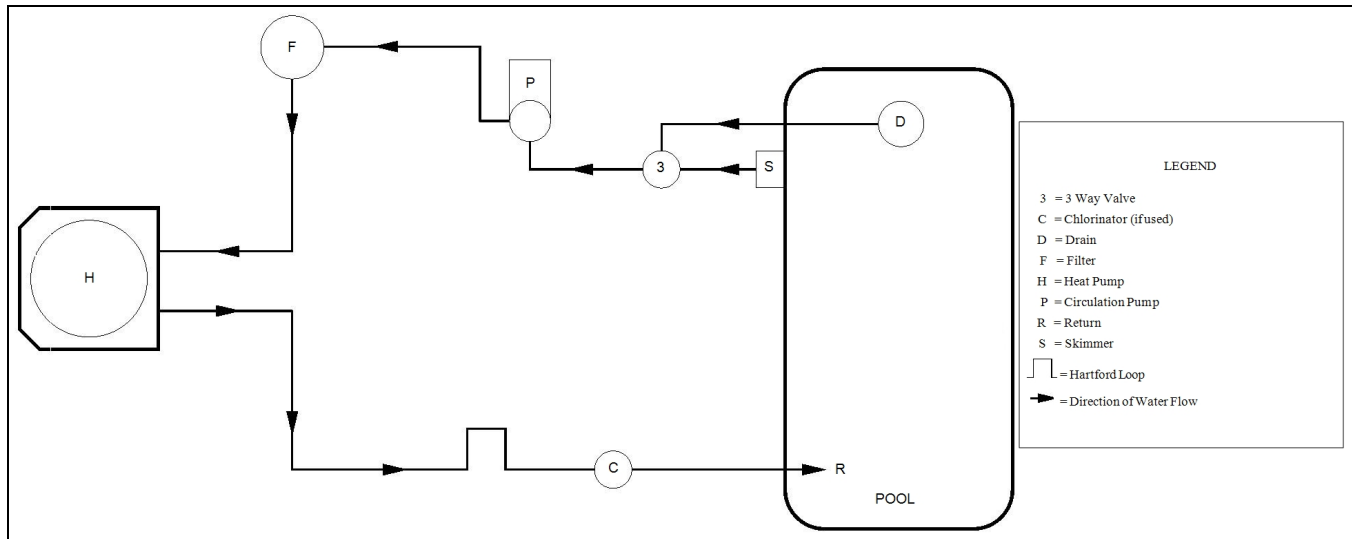

Heat Pump with water flows greater than the maximum listed flow rate

See "Water Flow Rates" on page 17.

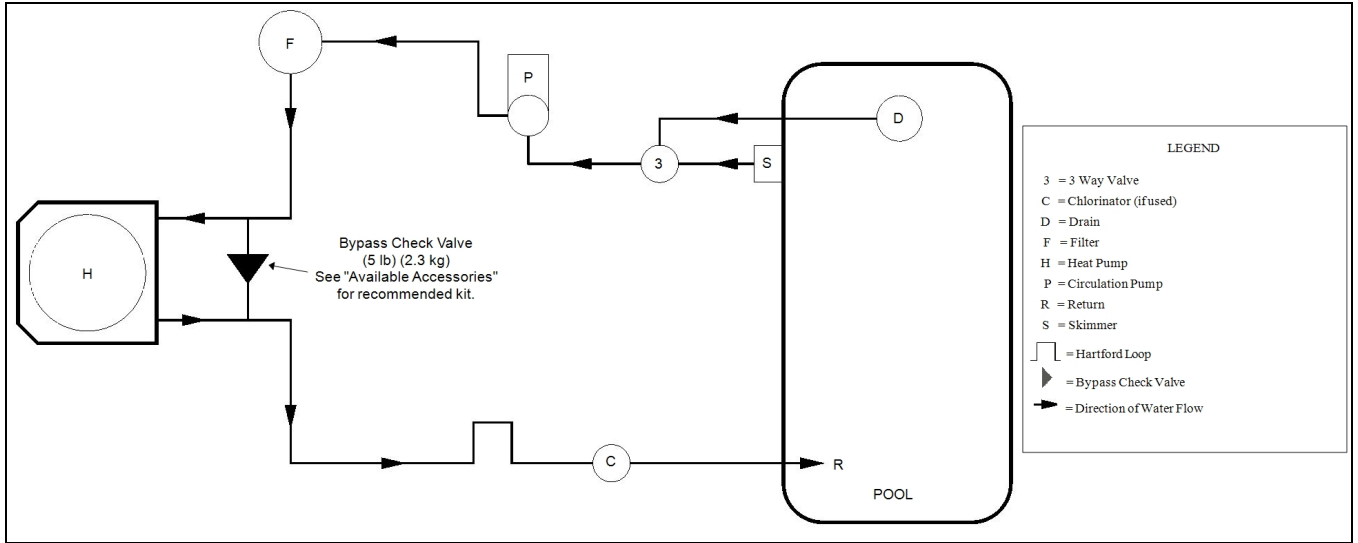

Heat Pump with Spillover Spa (One filter Pump)

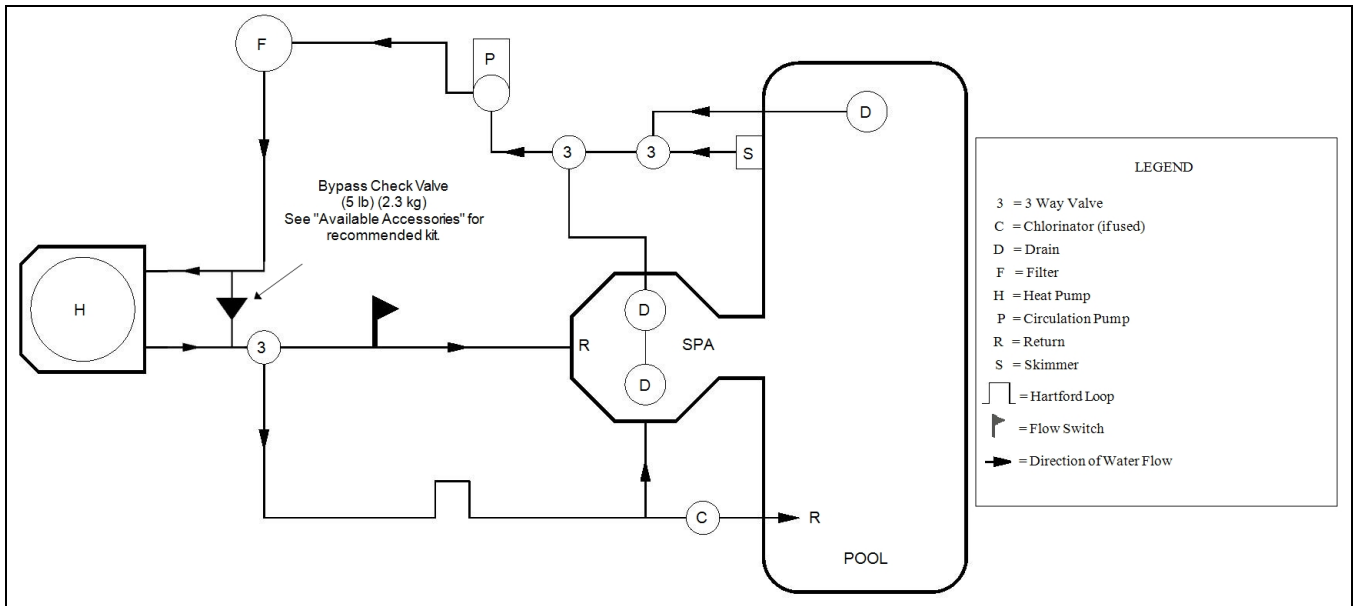

Heat Pump with Spillover Spa (Two filter Pumps)

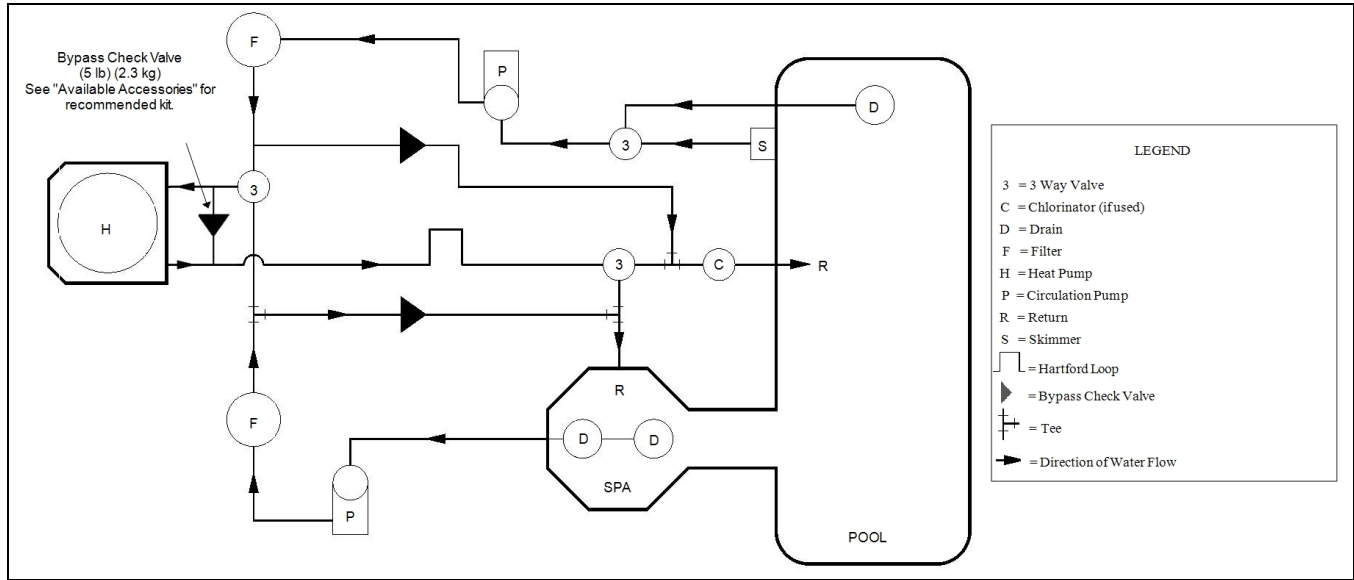

Heat Pump with Gas Heater backup

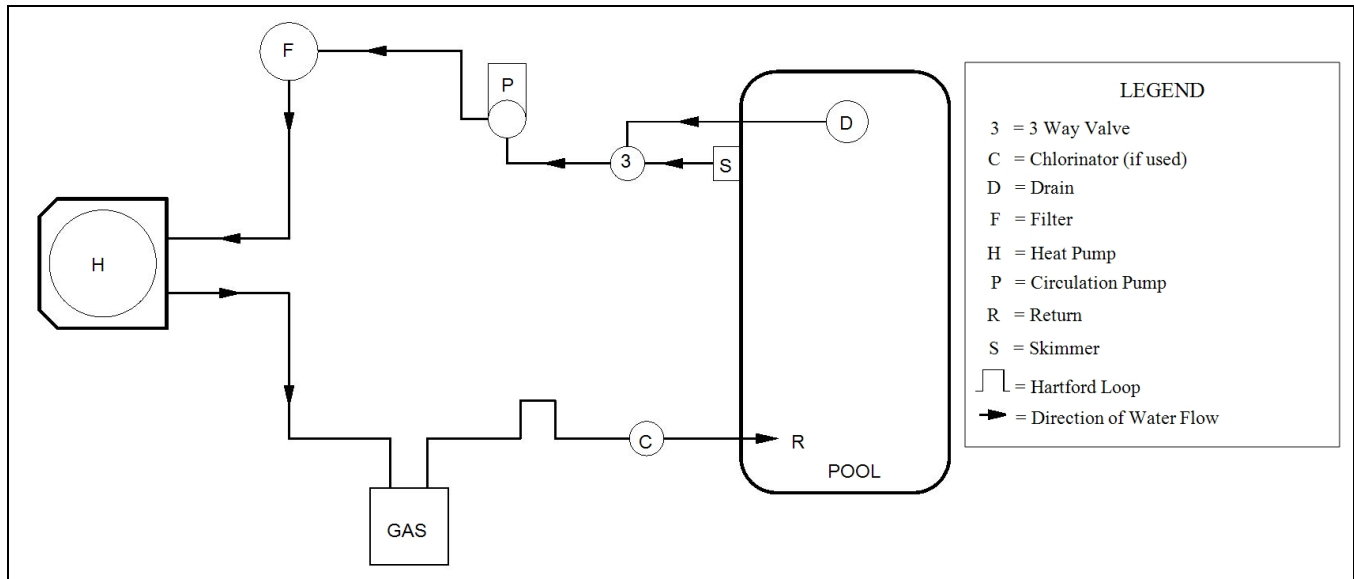

Heat Pump with Solar Panels in Plumbing Circuit (not controlled by AquaCal heat pump)

The solar panels are controlled by a system other than the Heat Pump.

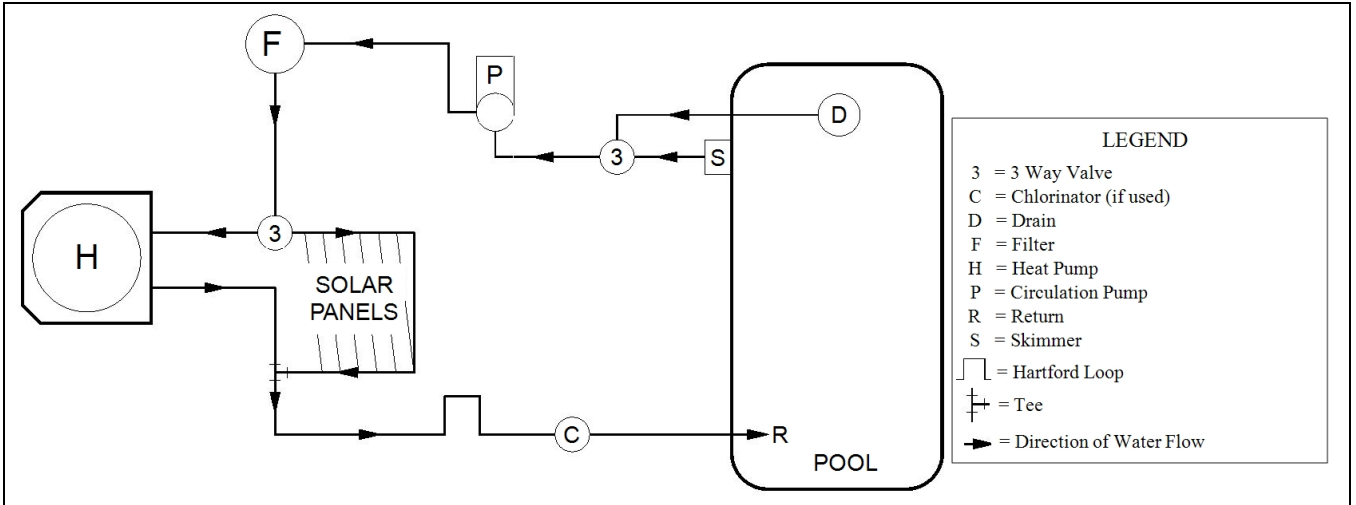

Heat Pump with Solar Panels in Plumbing Circuit (controlled by AquaCal heat pump)

See ("Solar Control") on the AquaCal website (["hp11-options-manuals"](http://www.aquacal.com/hp11-options-manuals)) for more information on controlling solar panels with the Heat Pump.

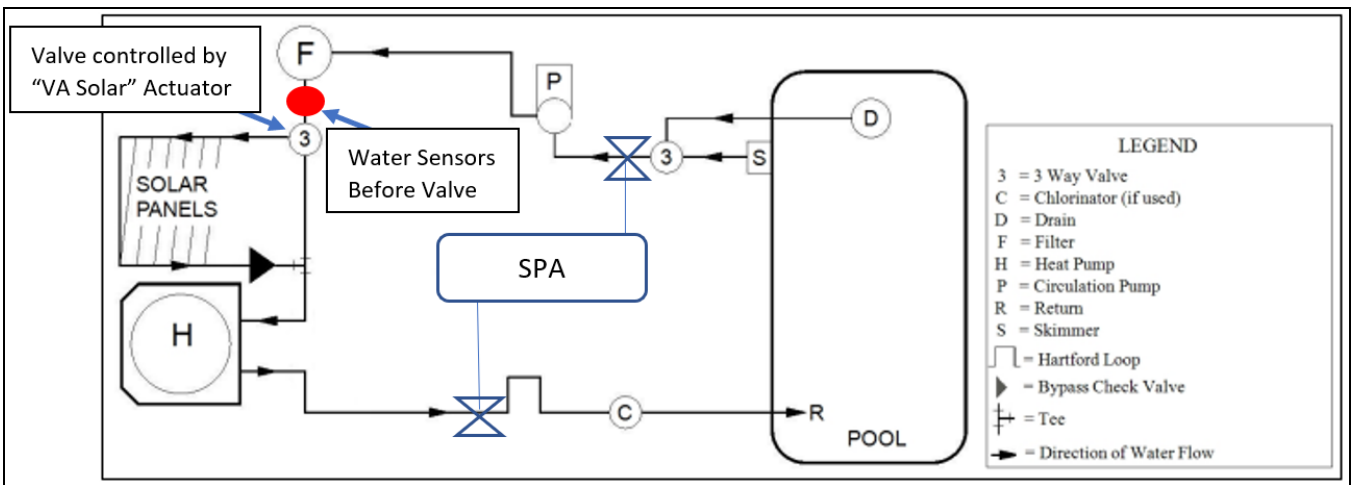

Multiple Air Source Heat Pumps

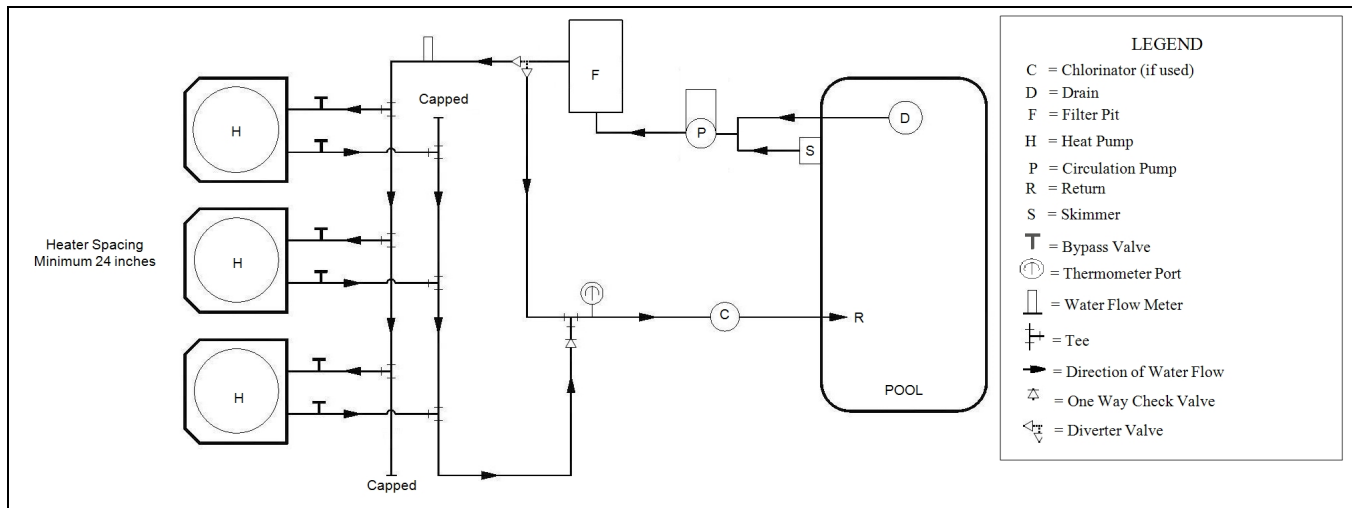

1.4.C Maintaining Ability to Winterize

NOTICE

Failure to heed the following may result in damage to equipment.

- Do not use glue on the threaded portion of the equipment's unions. A glued-in-place union will prevent the equipment from being properly winterized.

1.4.D Water Connections to Heat Pump

- Heat Pump union sizes are specified on diagram(s).
- Connections to site plumbing are made via PVC solvent cement to the female slip socket of the plumbing unions.
- Plumbing unions are available from AquaCal®.

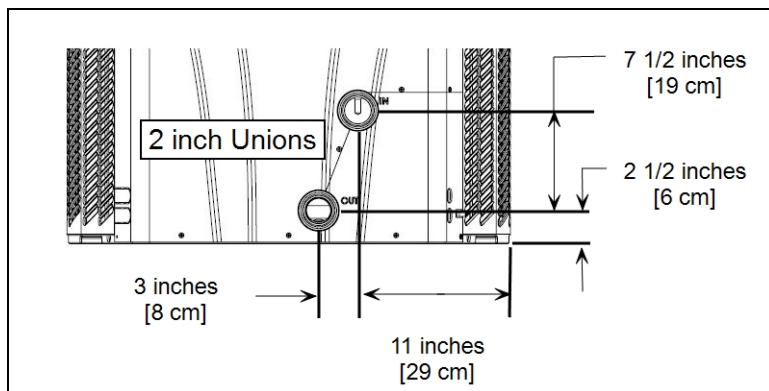

1.4.E In-Line Chlorine Feeders

Place in-line chlorinators downstream from the heat pump and as low in elevation as possible.

- If an erosion type feeder is used, it is recommended that a Hartford Loop be installed to protect internal heat pump components.
- A Hartford Loop is not required when using a Salt Chlorine Generator.
- Avoid storing corrosive chemicals near the heat pump to minimize potential damage to the exterior of the heat pump.
- Heat Pump equipment shall not be installed immediately after an injection point of low pH or acidic chemicals. This will minimize potential corrosive damage to the inside of the heater.

Heat Pump with Erosion Tablet Feeder and Hartford Loop

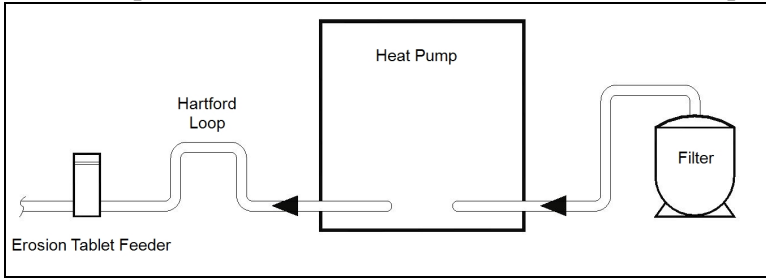

1.4.F Water Flow Rates

Maintain water flow rates as indicated. Please note, these specifications relate to the heat pump only. Code-specified whole system turnover rates must be satisfied.

NOTICE

Failure to heed the following may result in damage to equipment.

- Water flow exceeding maximum flow rates will negatively affect the total pool filtration performance and may damage the heat pump. This will not be covered under the equipment warranty.

MODEL	HEAT EXCHANGER TYPE	FLOW RATES	
		MINIMUM	MAXIMUM
SQ140R	Titanium ThermoLink [®]	30 GPM (113.6 L/min)	70 GPM (265 L/min)
SQ200R	Titanium ThermoLink [®]	30 GPM (113.6 L/min)	70 GPM (265 L/min)
TC1000	Titanium ThermoLink [®]	30 GPM (113.6 L/min)	70 GPM (265 L/min)
TC1500	Titanium ThermoLink [®]	30 GPM (113.6 L/min)	70 GPM (265 L/min)
TC500	Titanium Tube-in-Tube	20 GPM (75.7 L/min)	45 GPM (170 L/min)

* Head Loss - 30 GPM = 1.5 PSI, 70 GPM = 8.2 PSI

PLEASE NOTE -

If minimum flow rates are not met, heat pump output is reduced and performance will suffer. Internal safety devices may deactivate the heat pump with the following errors:

- **HIGH PRESSURE FAULT**
- **HP5 SYSTEM LOCKOUT**
- **LOW PRESSURE FAULT**
- **LP5 SYSTEM LOCKOUT**

- Operate water filtration devices per manufacturer's specifications. Dirty filters can cause a reduction of water flow to the heat pump. An increase of 7-10 psi (48 to 69 kPa) higher than the clean filter pressure typically reduces flow rates. This requires the filter to be cleaned or back-washed.
- Keep baskets free of debris. A large quantity of debris in the pump and skimmer baskets can reduce water flow.
- Check for improper valve settings. A partially closed valve after the filter, or a full-open bypass around the heat pump, will cause insufficient water flow through the heat pump.
- The maximum operating pressure is 50 psi (345 kPa). These specifications relate to the heat pump only.
- The heat pump is not intended to be installed on high pressure applications.
- Code-specified whole system turnover rates must be satisfied.

1.4.G Heat Pump Bypass Requirements

The heat pump requires a certain water flow rate in order to operate properly. A bypass can be used to regulate the flow to the Heat Pump. See "*Water Flow Rates*" on the previous page.

Bypass Valve Kit (# STK0135)

- When high flow rates are outside recommended specifications, please use this kit or an alternative bypass valve system.
- This kit can be used to control excessive water flow through the heat pump. It provides automatic flow adjustments for most applications.



Grid Flow Switch (# 0040S)

- Used for automatic pool/spa thermostat switching.
- This switch can also be used in place of the water pressure switch. This may be needed when the pool / spa elevation is higher than the heat pump. A higher elevation of the water can cause a false signal to the heat pump; indicating water is flowing through the heat pump when it isn't.
- This kit is not to be used on applications exceeding 50 PSI (345 kPa).



1.5 Programming

IN THIS SECTION:

1.5.A Setting Date and Time	19
1.5.B Setting Date and Time Format	19
1.5.C Selecting Celsius or Fahrenheit	20
1.5.D Activate HEAT Mode, COOL Mode, AUTO Mode, or Deactivate Equipment	21
1.5.E Set a desired temperature (setpoint) for the Heat Pump to activate	22
1.5.F Using Shortcuts	23

1.5.A Setting Date and Time









The date and time are required in order to allow schedules to operate properly.

Set the heat pump's date and time using the following steps.

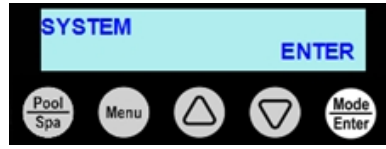
PLEASE NOTE:

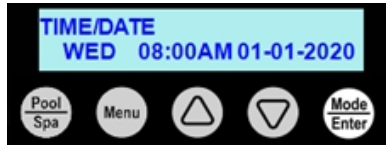
If a PoolSync[®] device is attached and in-use, the time and date will automatically be set and maintained. Be sure to select the proper time zone in the PoolSync[®] menu.

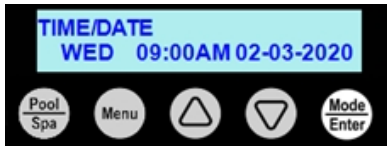
Enter "System" menus, then proceed

A PRESS MENU BUTTON 	B USE ARROWS TO "SYSTEM" 	C PRESS "ENTER" 
1 USE ARROWS TO MENU "TIME / DATE" 	2 PRESS ENTER, ITEM TO CHANGE WILL BLINK 	3 USE ARROWS TO CHANGE 
4 ENTER TO SAVE 	MENU TO EXIT, PRESS & HOLD TO STATUS 	

1.5.B Setting Date and Time Format

The heat pump's date and time format can be customized.

Customize Time

The time can be displayed in 24-hour *military* time (the default display is 12-hour).

Enter "System" menus, then proceed

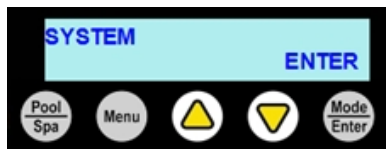
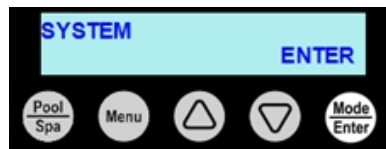
A PRESS MENU BUTTON 	B USE ARROWS TO "SYSTEM" 	C PRESS "ENTER" 
---	---	---

<p>1 USE ARROWS TO MENU "TIME FORMAT"</p>	<p>2 ENTER TO EDIT</p>	<p>3 USE ARROWS TO CHANGE</p>
<p>4 ENTER TO SAVE</p>	<p>MENU TO EXIT, PRESS & HOLD TO STATUS</p>	

Customize Date

The date can be displayed as Day-Month-Year (the default is Month-Day-Year).

Enter "System" menus, then proceed

<p>A PRESS MENU BUTTON</p>	<p>B USE ARROWS TO "SYSTEM"</p>	<p>C PRESS "ENTER"</p>
<p>1 USE ARROWS TO MENU "DATE FORMAT"</p>	<p>2 ENTER TO EDIT</p>	<p>3 USE ARROWS TO CHANGE</p>
<p>4 ENTER TO SAVE</p>	<p>MENU TO EXIT, PRESS & HOLD TO STATUS</p>	

1.5.C Selecting Celsius or Fahrenheit

Set the water temperature to show in either Fahrenheit (default) or Celsius.

Enter "System" menus, then proceed

<p>A PRESS MENU BUTTON</p>	<p>B USE ARROWS TO "SYSTEM"</p>	<p>C PRESS "ENTER"</p>
-----------------------------------	--	-------------------------------

1 USE ARROWS TO "TEMPERATURE UNITS"

2 ENTER TO EDIT

3 USE ARROWS TO CHANGE

4 ENTER TO SAVE

MENU TO EXIT, PRESS & HOLD TO STATUS

1.5.D Activate HEAT Mode, COOL Mode, AUTO Mode, or Deactivate Equipment

Press "Mode / Enter" button until the desired mode is displayed.

- "HEAT" mode - After the fan and compressor start, the red "Heating" light will activate.
- "COOL" mode - After the fan and compressor start, the blue "Cooling" light will activate.
- "AUTO" mode - After the fan and compressor start, the heat pump will maintain the set temperature within 1°. The red "Heating" or blue "Cooling" light will activate.
- "OFF" - The heat pump will indicate it is deactivated. Any equipment connected to the heat pump will continue to operate. To deactivate all equipment connected to the heat pump, activate the service mode. See "Service Mode" on page 46.

HEAT THE WATER
Use Mode Button to Select

COOL THE WATER
Use Mode Button to Select

USE AUTO MODE
Use Mode Button to Select

DEACTIVATE UNIT
Use Mode Button to Select

1.5.E Set a desired temperature (setpoint) for the Heat Pump to activate

Press the up or down arrow to set the desired temperature (setpoint) for the water.

- The heating indicator will illuminate when heating the water.
- The cooling indicator will illuminate when cooling the water.

PLEASE NOTE:

- The maximum temperature the Heat Pump can be set to is 104° F (40° C).

PLEASE NOTE:

The heat pump will not operate if incoming water temperatures are above 108° F (42° C). If sustained water temperatures will fall below 32° F (0° C), the equipment must be winterized in order to prevent damage. See "Winterizing" on page 62.

NOTE:

If a group's schedule is active and the temperature setpoint is changed, that group's temperature setpoint will also be changed.

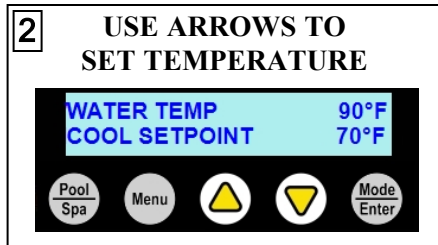
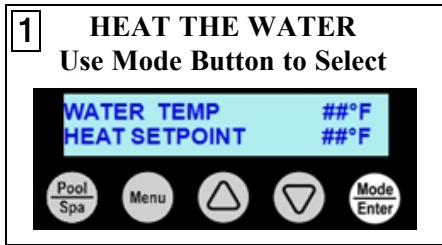

1.5.F Using Shortcuts

The shortcuts menu provides quick access to model specific options and features. The following outlines some of these options.

Service Mode

This mode will deactivate the heat pump as well as all equipment connected to the heat pump.

- (See "Service Mode" on page 46 for more information.)

Group Access

NOTE

*The standard (from the factory) heat pump **does not have** a group or schedule. These can be created as needed depending on if a heat pump option has been utilized. See [Product Manual Options](#) for more information on available options.*

As a group is created, a shortcut automatically appears in the shortcuts menu. The user can activate the group by shortcut and will be asked how long to operate that group.

- Multiple group shortcuts can operate at the same time. The time remaining for each group to operate will appear on the status screen.
- After the group shortcut timer expires, the heat pump group will resume its normally scheduled activity.
- To cancel the group shortcut's operation before its timer expires, go to the shortcut menu, select it, and choose "STOP".
- See "Using a Group Shortcut" on the next page.
- See "Stopping a Group Shortcut" on the next page.

PLEASE NOTE:

The Spa and Pool groups (if applicable) will not appear in the shortcuts menu. Use the schedules or the Pool / Spa button to activate those groups.

Schedule Mode

NOTE

*The standard (from the factory) heat pump **does not have** a group or schedule. These can be created as needed depending on if a heat pump option has been utilized. See [Product Manual Options](#) for more information on available options.*

There are three modes that can be set when running schedules.

- "AUTO" - The default mode. This allows schedules to run normally.
- "AWAY" - This mode is generally used when the user is away on vacation and doesn't want to maintain a water temperature. The heat pump will be deactivated while the rest of the schedules (including filtration) are allowed to continue.
- "OFF" - This mode turns off all schedules. The schedules resume when the schedule mode is set to "AUTO" again.
- (See "Schedule and Program Modes" on page 41 for more information.)

Using a Group Shortcut

In this example, a user activates a group that was previously created called "FILTRATION".

<p>A PRESS MENU BUTTON</p>	<p>B USE ARROWS TO "SHORTCUTS"</p>	<p>C PRESS "ENTER"</p>
<p>1 ARROWS TO SHORTCUT TO USE</p>	<p>2 ENTER TO SELECT SHORTCUT</p>	<p>3 ENTER TO START</p>
<p>4 ARROWS TO MAXIMUM TIME TO OPERATE</p>	<p>5 ENTER TO ACTIVATE</p>	<p>MENU TO EXIT, PRESS & HOLD TO STATUS</p>

On the status screen the group will show as active. It will then display the time remaining before the group expires.

Stopping a Group Shortcut

In this example a group called "FILTRATION" is deactivated before it's time expires.

<p>A PRESS MENU BUTTON</p>	<p>B USE ARROWS TO "SHORTCUTS"</p>	<p>C PRESS "ENTER"</p>
<p>1 ARROWS TO SHORTCUT TO STOP</p>	<p>2 ENTER TO SELECT</p>	<p>3 ENTER TO STOP</p>

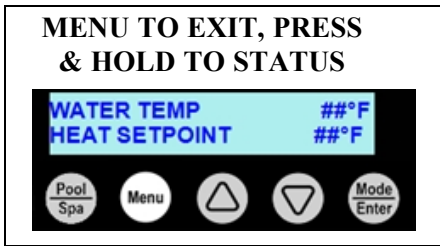

1.6 Optional Installations

The heat pump can have features installed as options. This section describes those additional options.

PLEASE NOTE

Some of these features depend on having an expansion board installed in the system. If the feature is needed, and the expansion board is not installed, it can be purchased and installed separately. See "Expansion Board Upgrade Kit (# STK0271)" on page 54.

ALSO NOTE:

- *AquaCal® can not guarantee all devices from other manufacturers can be successfully connected and used by the heat pump. Some equipment may have incompatible firmware or hardware.*
- *Some manufacturers may update equipment firmware and render it unable to control or be controlled by the heat pump. AquaCal makes no guarantee of such equipment updates not interfering with equipment performance.*
- *In addition, not all external controllers will be able to control heat pumps with a cooling mode. If this is needed, it is suggested that an AquaCal® PoolSync® application be used.*

1.6.A Supplemental Options

For more information visit the options manuals at <https://www.aquacal.com/hp11-options-manuals/>.

Connecting an Air Sensor for Freeze Protection

- As an option, an air sensor can be installed for the freeze protection feature (Expansion Board Required). The air temperature is then used to monitor for freezing conditions instead of the water. This sensor can monitor the element's changes faster for possible freezing conditions.

Relays & Actuators

- Connect relay-controlled devices and actuator controlled devices (valves) to the heat pump.

Circulation Pumps

- Connect and control compatible circulation pumps to the heat pump.

External Controllers

- To support a direct connection to an external controller, AquaCal® heat pumps are equipped with removable terminal blocks on the control board.

Using Multiple Heat Pumps

- Up to 16 heat pumps can be connected and controlled from a primary heat pump.

Solar Control

- With the addition of an expansion board, a valve actuator, and three 10 k temp sensors, the AquaCal heat pump can function as an advanced solar controller.

1.7 Optional Programming

IN THIS SECTION:

1.7.A Configure to use WiFi	26
1.7.B WiFi modes	28
1.7.C Configuring Groups	29
C.1 Create a Group	29
C.2 Edit a Group	31
C.3 Delete a Group	32
1.7.D Configuring Schedules	32
D.1 Create a Schedule	33
D.2 Edit a Schedule	34
D.3 Delete a Schedule	35
1.7.E Freeze Protection	36
1.7.F Setting Entry Code Option	38
1.7.G Disabling Entry Code Option	39
1.7.H Schedule and Program Modes	41

1.7.A Configure to use WiFi

Selected heat pumps come with WiFi. This can be activated and control the heat pump remotely. If the heat pump does not have internal WiFi, the user can order a wall mounted WiFi device. See "*PoolSync® WiFi Controller (PS0001)*" on page 54.

Steps to activate:

1. The user needs to have the credentials for the home's WiFi access point (user name and password). This will be required to set up the heat pump.
2. Download the WiFi application on to a mobile device.

The application can be downloaded here:



Look for the PoolSync® application from AquaCal AutoPilot, Inc.

3. Using the mobile application:
 - a. Select "ADD NEW".
 - b. Select "WiFi Heat Pump".
4. At the heat pump:
 - a. Use the following menus to activate WiFi.

Setup at heat pump

Enter "Advanced" menus, then proceed

<p>A PRESS MENU BUTTON</p>	<p>B USE ARROWS TO "SYSTEM"</p>	<p>C PRESS "ENTER"</p>
<p>D USE ARROWS TO "ADVANCED"</p>	<p>E PRESS "ENTER"</p>	<p>1 USE ARROWS TO MENU "POOLSYNC WiFi"</p>
<p>2 PRESS "ENTER"</p>	<p>3 USE ARROWS TO "MODE"</p>	<p>4 PRESS "ENTER"</p>
<p>5 USE ARROWS TO "SETUP"</p>	<p>6 PRESS "ENTER"</p>	<p>7 PRESS "OK" AND GO TO APP</p>

8. Using the mobile application:
 - a. Select "CHECK & BEGIN",
 - b. Select "Allow while using" to find the heat pump's WiFi .
 - c. Select "Join" on the WiFi network for the "PoolSync-####".
 - d. Select "ALLOW" to find home devices on the local networks.
 - e. After a few moments, the user will be asked to choose and enter the home's WiFi credentials.
 - f. Then select "CONNECT".
9. At the heat pump:
 - a. The user will then be asked to authenticate the mobile device.

9 PRESS "ENTER"

10. Using the mobile application:
 - a. After reviewing the permissions, select "FINISH SETUP" on the application.
 - b. WiFi should now be available to control the heat pump.

NOTE

If the setup process has been interrupted or stopped in some way, the user can reset the WiFi to factory settings and then restart.

1. Using the mobile application, Select the three dots in the upper right of the application to get to settings.
 - a. Select "Factory Reset" and "OK".
 - b. Refresh the screen by doing a swipe down, then if necessary, select "Remove Device" and "OK".
2. At the heat pump, change the mode to "OFF".
3. Restart the setup process as needed. (See "Setup at heat pump" on the previous page for more information.)

1.7.B WiFi modes

The heat pump's WiFi system can be configured to use several modes. This section describes each mode and when to use them.

PLEASE NOTE:

This mode is different than the primary heat pump mode on the main display which controls heating modes and menu entry.

Activating a Heat Pump's WiFi mode:

Enter "Advanced" menus, then proceed

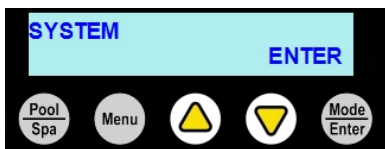
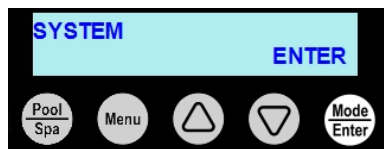
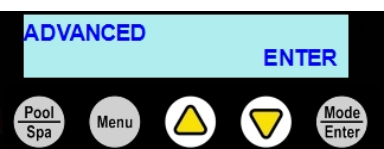
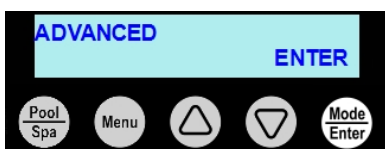
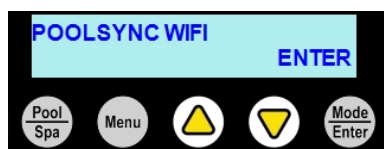
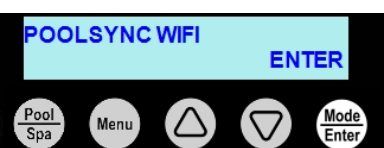
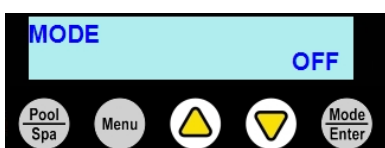
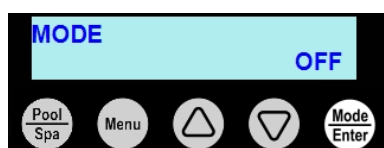
<p>A PRESS MENU BUTTON</p> 	<p>B USE ARROWS TO "SYSTEM"</p> 	<p>C PRESS "ENTER"</p> 
<p>D USE ARROWS TO "ADVANCED"</p> 	<p>E PRESS "ENTER"</p> 	<p>1 USE ARROWS TO MENU "POOLSYNC WiFi"</p> 
<p>2 PRESS "ENTER"</p> 	<p>3 USE ARROWS TO "MODE"</p> 	<p>4 PRESS "ENTER"</p> 

5. Select a mode, and hit enter. Possible modes include "SETUP", "SERVICE ACCESS", "NORMAL", and "OFF".

The "SETUP" mode:

- This mode is used when activating the WiFi on select heat pumps.
- This mode will automatically deactivate once the setup process has completed.
- This mode will timeout automatically after 20 minutes if no setup action is performed.

The "SERVICE ACCESS" mode:

- This mode turns the heat pump's WiFi into an access point and is used by installers to gain access when the User's home WiFi access credentials are not known.
- This mode will timeout automatically after 20 minutes if no setup action is performed.

The "NORMAL" mode:

- This mode indicates that WiFi is active. No action is required.

The "OFF" mode:

- This mode is used when the heat pump either does not have WiFi access, or the user is using a wall mounted PoolSync® WiFi device.

1.7.C Configuring Groups

A group is used to control multiple devices (equipment) connected to the heat pump, either by manually activating the group through a shortcut, or scheduling the group to activate at a specified time.

EXAMPLES IN THIS SECTION:

C.1 Create a Group	29
C.2 Edit a Group	31
C.3 Delete a Group	32

C.1 Create a Group

EXAMPLES OF GROUPS THAT CAN BE CREATED:

- A Custom Filtration Group -
 - This group could be used if the user didn't want to regulate the temperature of the water the entire time the circulation pump is activated. A custom group can be created that separates the amount of filtration time from the amount of time allowed for the heat pump to heat or cool the water.

The example below shows a "FILTRATION" group being created manually. A circulation pump will be added to the group.

Enter "Groups" menus, then proceed

A PRESS "MENU" BUTTON

B USE ARROWS TO "GROUPS"

C PRESS "ENTER"

1 USE ARROWS TO "NEW GROUP SETUP"

2 ENTER TO CREATE

3 USE ARROWS TO NAME "FILTRATION"

4 ENTER TO SAVE

5 USE ARROWS TO SET MAXIMUM ACTIVE TIME

6 ENTER TO SAVE

7 USE ARROWS TO SET FREEZE PROTECT OPTION

8 ENTER TO SAVE

9 PRESS BUTTON UNDER "YES" TO SAVE

10 PRESS "ENTER" TO ADD EQUIPMENT

11 USE ARROWS TO SELECT EQUIPMENT

12 ENTER TO SAVE

13 USE ARROWS TO SET RPM

14 ENTER TO SAVE

MENU TO EXIT, PRESS & HOLD TO STATUS

The group is now ready to be activated using a shortcut or scheduled to activate at a certain time.

- See "Using a Group Shortcut" on page 24.
- See "Create a Schedule" on page 33.

C.2 Edit a Group

The example below shows a "FILTRATION" group being edited.

An existing variable speed circulation pump will be deleted and an attached single speed circulation pump (named "POOL PUMP") will be added. The device will be set to be "ON" when the group is active.

Enter "Groups" menus, then proceed

<p>A PRESS "MENU" BUTTON</p> 	<p>B USE ARROWS TO "GROUPS"</p> 	<p>C PRESS "ENTER"</p> 
<p>1 USE ARROWS TO "FILTRATION GROUP"</p> 	<p>2 ENTER TO EDIT</p> 	<p>3 USE ARROWS TO "REMOVE EQUIPMENT"</p> 
<p>4 ENTER TO SELECT</p> 	<p>5 USE ARROWS TO DEVICE TO REMOVE</p> 	<p>6 ENTER TO SELECT</p> 
<p>7 PRESS BUTTON UNDER "YES" TO CONFIRM</p> 	<p>8 USE ARROWS TO "ADD EQUIPMENT"</p> 	<p>9 ENTER TO SELECT</p> 
<p>10 USE ARROWS TO DEVICE TO ADD</p> 	<p>11 ENTER TO SELECT</p> 	<p>12 USE ARROWS TO SELECT DEVICE STATE</p> 

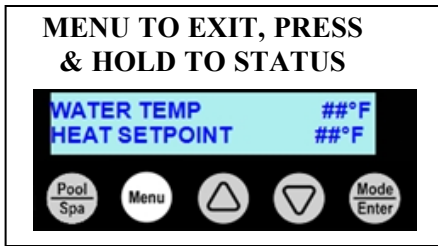
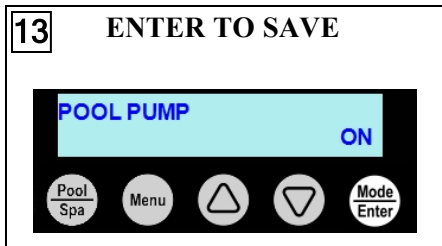

C.3 Delete a Group

The example below shows a "FILTRATION" group being deleted. Any schedules associated with that group will also be deleted.

Enter "Groups" menus, then proceed

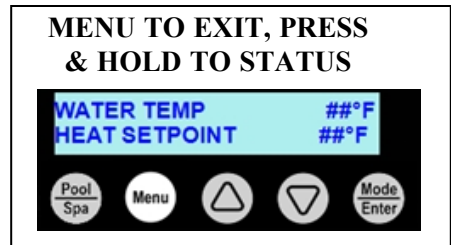
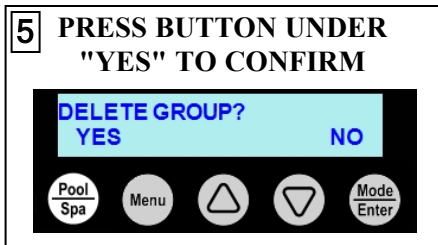
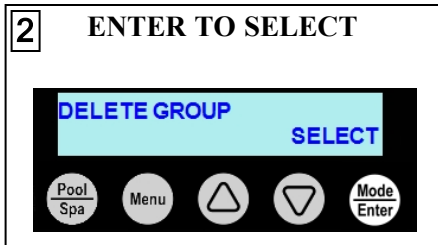
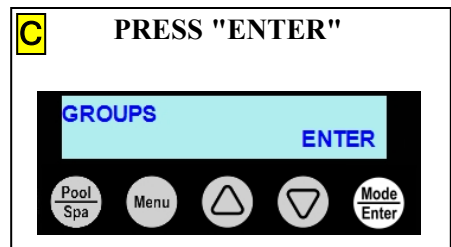
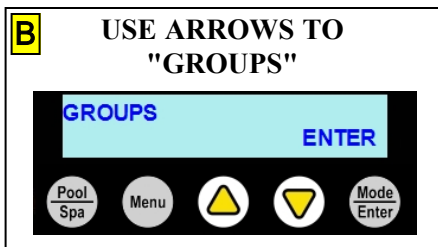

1.7.D Configuring Schedules

A schedule can be used to activate a group of devices at a specified time.

- See "Configuring Groups" on page 29.

EXAMPLES IN THIS SECTION:









D.1 Create a Schedule	33
D.2 Edit a Schedule	34
D.3 Delete a Schedule	35

D.1 Create a Schedule

A maximum of four (4) schedule programs can be configured for each group.

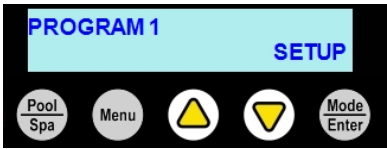
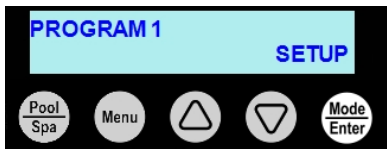
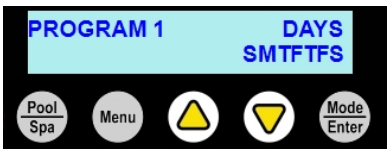
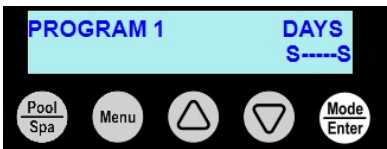
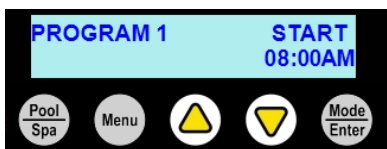
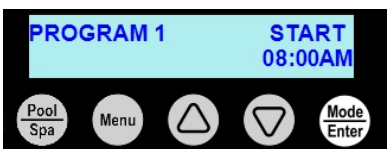
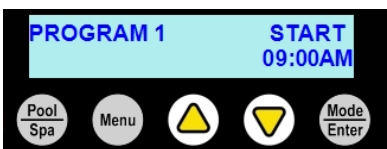
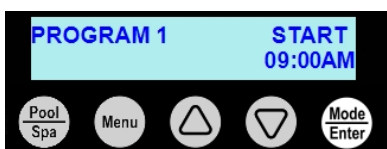
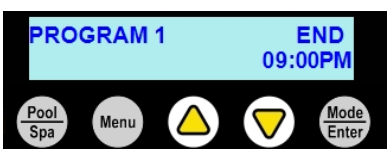
The example below shows a "FILTRATION" group being scheduled.

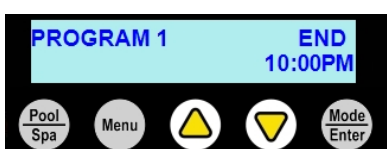
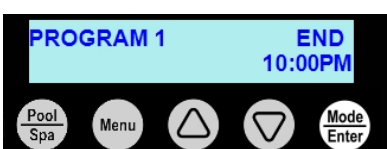
Enter "Schedules" menus, then proceed

A PRESS MENU BUTTON 	B USE ARROWS TO "SCHEDULES" 	C PRESS "ENTER" 
1 ARROWS TO GROUP TO SCHEDULE 	2 ENTER TO EDIT 	3 USE ARROWS TO THE PROGRAM TO SCHEDULE (1-4) 
4 ENTER TO EDIT 	5 USE ARROWS TO EDIT DAYS 	6 ENTER TO SAVE 
7 USE ARROWS TO "START" TIME 	8 ENTER TO EDIT 	9 USE ARROWS TO CHANGE 
10 ENTER TO SAVE 	11 USE ARROWS TO "END" TIME 	12 ENTER TO EDIT 
13 USE ARROWS TO CHANGE 	14 ENTER TO SAVE 	MENU TO EXIT, PRESS & HOLD TO STATUS 

D.2 Edit a Schedule

The example shows a pool group schedule being edited:

- From 8:00AM-5:00PM SMTWTFS (everyday)
- To 9:00AM-6:00PM -MTWTF- (Monday through Friday)

WARNING

Failure to heed the following may result in injury or death.

- When editing schedules containing the circulation pump, allow time for proper filtration.
- Follow all State and Local guidelines in regards to satisfying code-specified whole system turnover rates.

PLEASE NOTE:

This is not a recommended filtration schedule.

- What is shown is just an example of how to edit a schedule.
- A default schedule was initially created using an installation preset available in the installation menu.

Enter "Schedules" menus, then proceed

<p>A PRESS MENU BUTTON</p> 	<p>B USE ARROWS TO "SCHEDULES"</p> 	<p>C PRESS "ENTER"</p> 
<p>1 USE ARROWS TO "POOL GROUP"</p> 	<p>2 PRESS ENTER TO EDIT</p> 	<p>3 USE ARROWS TO SCHEDULE TO EDIT</p> 
<p>4 ENTER TO EDIT</p> 	<p>5 USE ARROWS TO "PROGRAM 1 DAYS"</p> 	<p>6 ENTER TO EDIT</p> 
<p>7 USE ARROWS TO CHANGE</p> 	<p>8 ENTER TO SAVE</p> 	<p>9 USE ARROWS TO "PROGRAM1 START"</p> 

<p>10 ENTER TO EDIT</p>	<p>11 USE ARROWS TO CHANGE</p>	<p>12 ENTER TO SAVE</p>
<p>13 USE ARROWS TO "PROGRAM1 END"</p>	<p>14 ENTER TO EDIT</p>	<p>15 USE ARROWS TO CHANGE</p>
<p>16 ENTER TO SAVE</p>	<p>MENU TO EXIT, PRESS & HOLD TO STATUS</p>	

D.3 Delete a Schedule

Select the group and then the program to edit. Use the clear option to remove the program's schedule.

In the following example, the group "FILTRATION" has a schedule in "PROGRAM 1" that will be cleared (deleted).

Enter "Schedules" menus, then proceed

<p>A PRESS MENU BUTTON</p>	<p>B USE ARROWS TO "SCHEDULES"</p>	<p>C PRESS "ENTER"</p>
<p>1 ARROWS TO SCHEDULED GROUP</p>	<p>2 ENTER TO EDIT</p>	<p>3 USE ARROWS TO PROGRAM TO EDIT</p>

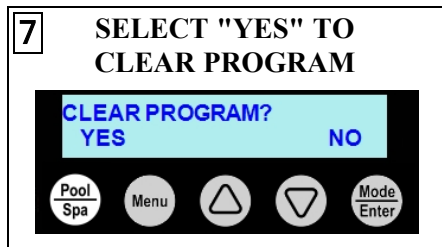
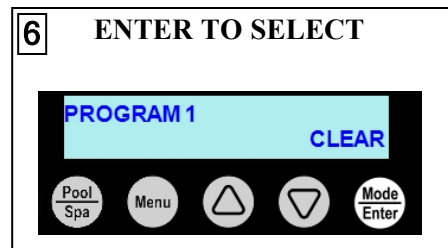
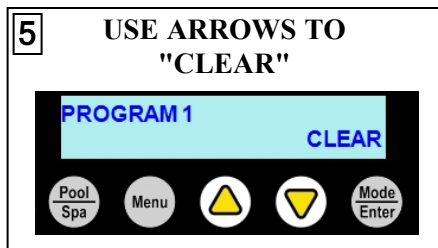
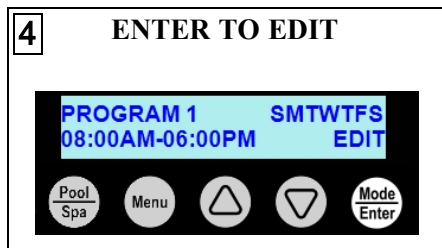

1.7.E Freeze Protection

NOTICE

Failure to heed the following may result in damage to equipment.

- By default (from the factory) the Freeze Protection feature ***WILL NOT*** protect the heat pump.
 - The Freeze Protection feature is dependent on equipment controlled by properly configured groups. Damage due to improperly configured or operated heat pumps are not covered under warranty.

When the heat pump and freeze protection has been properly configured to control the circulation pump, water is circulated through designated group's plumbing circuits in 5 minute cycles. The water circulation lowers the chances of water freezing in those circuits. See [Product Manual Options](#) for more information on available heat pump options and properly configuring groups.

Requirements for Freeze Protection

- A circulation pump must exist in the group to be protected.
- Water flow must be properly directed through a group's plumbing circuit.
- The group's freeze protection option must be set to on.

If properly configured:

- Freeze protection will automatically activate when the water temperature falls below 37° F (3° C).
- When the water temperature rises to 42° F (6° C), freeze protection will deactivate.
- These set temperatures and cycle times can be adjusted as needed in settings. See "*Adjusting Freeze Protection Options*" on the facing page.









NOTE:

- Freeze protection is meant to be temporary. If freezing temperatures will continue for an extended time frame, the pool equipment ***must*** be winterized.
- The heat pump will not attempt to heat water in freezing conditions.
- As a group cycles on and off, any devices contained within that group will also cycle on and off. If this behavior is undesirable, the device can either be removed from the group or manually deactivated.
- If a freeze protection air sensor has been installed and enabled, the air will be monitored instead of water.

Adjusting Groups to Allow Freeze Protection

In the following example, a "FOUNTAIN" group is edited to enable freeze protection.

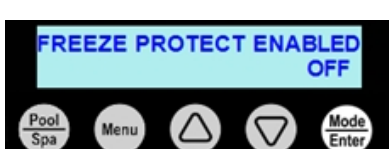
Enter "Groups" menus, then proceed

<p>A PRESS "MENU" BUTTON</p> 	<p>B USE ARROWS TO "GROUPS"</p> 	<p>C PRESS "ENTER"</p> 
<p>1 USE ARROWS TO GROUP TO EDIT</p> 	<p>2 PRESS "ENTER" TO EDIT</p> 	<p>3 ARROWS TO "FREEZE PROTECT ENABLED"</p> 
<p>4 PRESS "ENTER" TO EDIT</p> 	<p>5 USE ARROWS TO CHANGE TO "ON"</p> 	<p>MENU TO EXIT, PRESS & HOLD TO STATUS</p> 

Adjusting Freeze Protection Options

NOTICE



Failure to heed the following may result in damage to equipment.





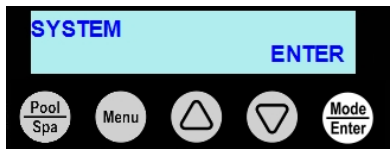

- Use extreme care when setting and adjusting freeze protection options. Improper freeze protection settings can cause damage to equipment. This is not covered by heat pump warranty.

Available freeze protection options:

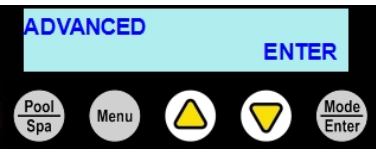
- "PROTECT ON SETPOINT" can be adjusted from 33° F to 39° F (.6° C to 4° C). The default is 37° F (3° C).
- "PROTECT OFF SETPOINT" can be adjusted from 40° F to 45° F (4° C to 7° C). The default is 42° F (5.5° C).
- "CYCLE TIME" can be adjusted from 5 to 20 minutes. The default is 5 minutes.
- "ACTIVE TIME" can be adjusted from 15 to 120 minutes. The default is 60 minutes.

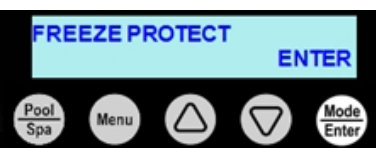
Enter "Advanced" menus, then proceed

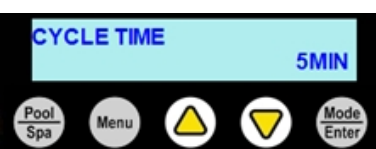
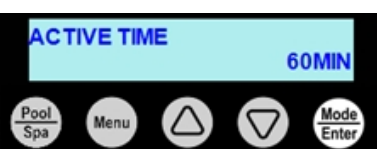
<p>A PRESS MENU BUTTON</p> 	<p>B USE ARROWS TO "SYSTEM"</p> 	<p>C PRESS "ENTER"</p> 
---	---	---

<p>D USE ARROWS TO "ADVANCED"</p> 	<p>E PRESS "ENTER"</p> 	<p>1 USE ARROWS TO MENU "FREEZE PROTECT"</p> 
<p>2 PRESS "ENTER" TO EDIT</p> 	<p>3 ENTER & ARROWS TO "PROTECT ON SETPOINT"</p> 	<p>4 ENTER & ARROWS TO "PROTECT OFF SETPOINT"</p> 
<p>5 ENTER & ARROWS TO "CYCLE TIME"</p> 	<p>6 ENTER & ARROWS TO "ACTIVE TIME"</p> 	<p>MENU TO EXIT, PRESS & HOLD TO STATUS</p> 

1.7.F Setting Entry Code Option





The entry code feature can prevent unauthorized access to the heat pump adjustments. This feature initiates after the heat pump goes into the sleep mode for the first time. This feature is commonly used on commercial applications.

NOTICE

Failure to heed the following may result in damage to equipment.

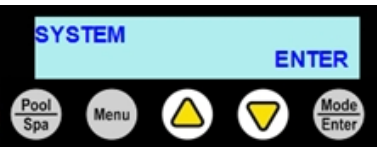
- **Before enabling the entry code feature, be sure to record the code.** If lost, the heat pump will require a program reset to regain access. This reset may require additional configuration by the installer.

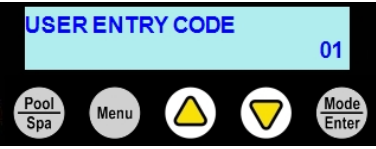
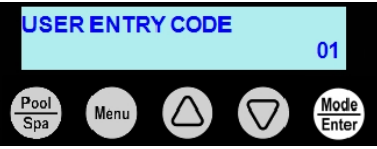
Enter "System" menus, then proceed

<p>A PRESS MENU BUTTON</p> 	<p>B USE ARROWS TO "SYSTEM"</p> 	<p>C PRESS "ENTER"</p> 
<p>1 USE ARROWS TO MENU "USER ENTRY CODE"</p> 	<p>2 ENTER TO EDIT</p> 	<p>3 USE ARROWS TO CHANGE</p> 

4 ENTER TO SAVE

5 USE ARROWS TO MENU "USER CODE ENABLED"

6 ENTER TO EDIT

7 USE ARROWS TO CHANGE

8 ENTER TO SAVE

MENU TO EXIT, PRESS & HOLD TO STATUS

1.7.G Disabling Entry Code Option

PLEASE NOTE -

- If an entry code has already been activated, the code must be entered before proceeding to disable.

Use Entry Code

1 USE ARROWS TO ENTER CODE

2 ENTER TO UNLOCK

Disable User Lock

Enter "System" menus, then proceed

A PRESS MENU BUTTON

B USE ARROWS TO "SYSTEM"

C PRESS "ENTER"

3 USE ARROWS TO "USER ENTRY CODE ENABLED"

4 ENTER TO EDIT

5 ARROWS TO CHANGE

6 ENTER TO SAVE

The LCD screen displays the text "USER ENTRY CODE ENABLED" on the top line and "OFF" on the bottom line. Below the screen are five circular buttons: "Pool Spa", "Menu", an up arrow, a down arrow, and "Mode Enter".

MENU TO EXIT, PRESS & HOLD TO STATUS

The LCD screen displays "WATER TEMP" and "##°F" on the top line, and "HEAT SETPOINT" and "##°F" on the bottom line. Below the screen are five circular buttons: "Pool Spa", "Menu", an up arrow, a down arrow, and "Mode Enter".

1.7.H Schedule and Program Modes

If the heat pump uses groups and schedules, the schedules can be deactivated temporarily as needed. Either globally through a schedule mode, or individually by setting a group's program mode.

NOTE

The standard (from the factory) heat pump **does not have** a group or schedule. These can be created as needed depending on if a heat pump option has been utilized. See [Product Manual Options](#) for more information on available options.

SCHEDULE MODE	Description	
"AUTO"	The default mode. This allows schedules to run normally.	See "Set Schedule Mode to "AUTO"" on the next page.
"AWAY"	This mode is generally used when the user is away on vacation and doesn't want to maintain water temperature. The heat pump will be deactivated while the rest of the schedules (including filtration) are allowed to continue.	See "Set Schedule Mode to "AWAY"" on the next page.
"OFF"	This mode turns off all schedules. The schedules resume when the schedule mode is set to "AUTO" again. Please note - this will also halt any connected circulation pump activity. This option is not meant for long term usage.	See "Set Schedule Mode to "OFF"" on page 43.

PROGRAM MODE	Description	
"ON"	A group's scheduled programs are set to operate normally.	See "Set Group Programs to "ON"" on page 43.
"PAUSED"	A group's scheduled programs will be paused. The programs will automatically resume the next scheduled day. No other group's activities will be effected.	See "Set Group Programs to "PAUSED"" on page 44.
"OFF"	This mode turns off all schedule programs for the group indefinitely. Programs resume when the program mode is set to "ON" again.	See "Set Group Programs to "OFF"" on page 45.

Set Schedule Mode to "AUTO"

Enter "Shortcuts" menus, then proceed

<p>A PRESS MENU BUTTON</p>	<p>B USE ARROWS TO "SHORTCUTS"</p>	<p>C PRESS "ENTER"</p>
<p>1 ARROWS TO "SCHEDULE MODE"</p>	<p>2 ENTER TO EDIT</p>	<p>3 ARROWS TO "AUTO"</p>
<p>4 ENTER TO SAVE</p>	<p>MENU TO EXIT, PRESS & HOLD TO STATUS</p>	







Set Schedule Mode to "AWAY"

Enter "Shortcuts" menus, then proceed

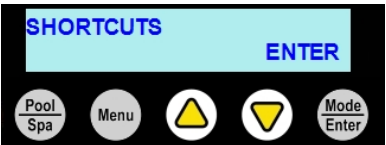
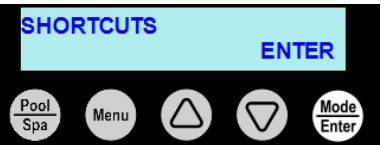
<p>A PRESS MENU BUTTON</p>	<p>B USE ARROWS TO "SHORTCUTS"</p>	<p>C PRESS "ENTER"</p>
<p>1 ARROWS TO "SCHEDULE MODE"</p>	<p>2 ENTER TO EDIT</p>	<p>3 ARROWS TO "AWAY"</p>
<p>4 ENTER TO SAVE</p>	<p>5 ARROWS AND ENTER TO SET END DATE</p>	
<p>MENU TO EXIT, PRESS & HOLD TO STATUS</p>		

Set Schedule Mode to "OFF"





Enter "Shortcuts" menus, then proceed

<p>A PRESS MENU BUTTON</p> 	<p>B USE ARROWS TO "SHORTCUTS"</p> 	<p>C PRESS "ENTER"</p> 
<p>1 ARROWS TO "SCHEDULE MODE"</p> 	<p>2 ENTER TO EDIT</p> 	<p>3 ARROWS TO "OFF"</p> 
<p>4 ENTER TO SAVE</p> 	<p>MENU TO EXIT, PRESS & HOLD TO STATUS</p> 	

Set Group Programs to "ON"

In the following example, a "Pool" group's set of scheduled programs will be set from "PAUSED" back to "ON".

Enter "Schedules" menus, then proceed

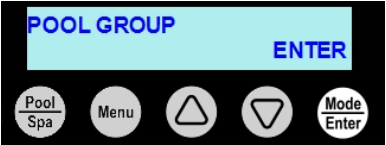
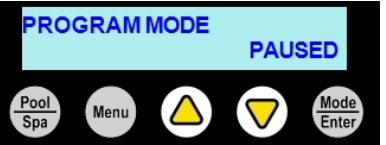
<p>A PRESS MENU BUTTON</p> 	<p>B USE ARROWS TO "SCHEDULES"</p> 	<p>C PRESS "ENTER"</p> 
<p>1 ARROWS TO "POOL GROUP"</p> 	<p>2 ENTER TO EDIT</p> 	<p>3 ARROWS TO "PROGRAM MODE"</p> 

4 ENTER TO EDIT

5 ARROWS TO "ON"

6 ENTER TO SAVE

MENU TO EXIT, PRESS & HOLD TO STATUS

Set Group Programs to "PAUSED"

In the following example, a "Pool" group's set of scheduled programs will be paused. This will continue until the programs are set back to "ON".

Enter "Schedules" menus, then proceed

A PRESS MENU BUTTON

B USE ARROWS TO "SCHEDULES"

C PRESS "ENTER"

1 ARROWS TO "POOL GROUP"

2 ENTER TO EDIT

3 ARROWS TO "PROGRAM MODE"

4 ENTER TO EDIT

5 ARROWS TO "PAUSED"

6 ENTER TO SAVE

MENU TO EXIT, PRESS & HOLD TO STATUS

Set Group Programs to "OFF"

In the following example, a "Pool" group's set of scheduled programs will be set from "ON" to "OFF".

The schedules will not resume until the programs are set back to "ON".

Enter "Schedules" menus, then proceed

A PRESS MENU BUTTON
WATER TEMP ##°F
HEAT SETPOINT ##°F
Pool Spa Menu [Up] [Down] Mode Enter

B USE ARROWS TO "SCHEDULES"
SCHEDULES ENTER
Pool Spa Menu [Up] [Down] Mode Enter

C PRESS "ENTER"
SCHEDULES ENTER
Pool Spa Menu [Up] [Down] Mode Enter

1 ARROWS TO "POOL GROUP"
POOL GROUP ENTER
Pool Spa Menu [Up] [Down] Mode Enter

2 ENTER TO EDIT
POOL GROUP ENTER
Pool Spa Menu [Up] [Down] Mode Enter

3 ARROWS TO "PROGRAM MODE"
PROGRAM MODE ON
Pool Spa Menu [Up] [Down] Mode Enter

4 ENTER TO EDIT
PROGRAM MODE ON
Pool Spa Menu [Up] [Down] Mode Enter

5 ARROWS TO "OFF"
PROGRAM MODE OFF
Pool Spa Menu [Up] [Down] Mode Enter

6 ENTER TO SAVE
PROGRAM MODE OFF
Pool Spa Menu [Up] [Down] Mode Enter

MENU TO EXIT, PRESS & HOLD TO STATUS
WATER TEMP ##°F
HEAT SETPOINT ##°F
Pool Spa Menu [Up] [Down] Mode Enter





IN THIS SECTION:

2.1 Service Mode	46
2.2 Service Help	47
2.3 Adjustments	48
2.3.A Adjusting Water Flow Using ΔT (Delta-T)	48
2.3.B Adjusting Water Pressure Switch (Select Units)	49
2.3.C Three-Phase Adjustment	50
2.4 Defaults	51
2.4.A Equipment Parameters	51
2.4.B Factory Reset	52
2.5 Supplemental	53
2.5.A Additional Options	53
2.5.B Available Accessories	53
2.5.C Cleaning Equipment After Installation	55
2.5.D Irrigation and Storm Run-Off	56
2.5.E Initial Cooling Recommendations	56
2.5.F Initial Heating Recommendations	56
2.5.G Saving Installer Settings to USB	57
2.5.H Use Installer Settings from USB	58
2.5.I Site Configuration Presets (Optional)	59
2.5.J Standards	61
2.5.K FCC Compliance	62
2.5.L Winterizing	62
2.6 System Information	64
2.6.A Dimensions	64
2.6.B Identifying Model Specifications	64
2.6.C Viewing System Information	65
2.6.D Viewing MAC Address (Configured WiFi Only)	66
2.6.E Weights	66

2.1 Service Mode

The heat pump can be set into a service mode where all connected devices and programmed schedules including the heat pump can be deactivated for servicing. While in service mode, connected devices / equipment can be manually activated as needed.

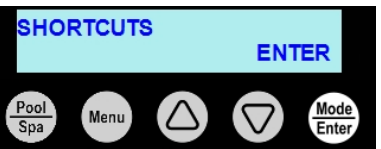
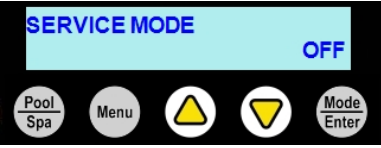
Enter "Shortcuts" menus, then proceed

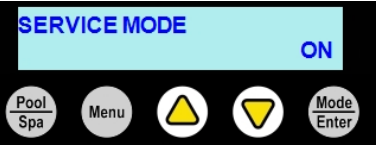
<p>A PRESS MENU BUTTON</p> 	<p>B USE ARROWS TO "SHORTCUTS"</p> 	<p>C PRESS "ENTER"</p> 
<p>1 USE ARROWS TO MENU "SERVICE MODE"</p> 	<p>2 PRESS ENTER TO EDIT</p> 	<p>3 USE ARROWS TO "ON"</p> 

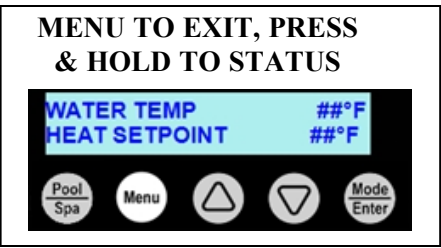
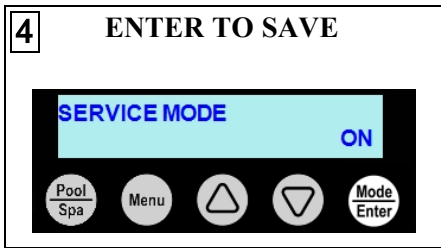

When service is complete, repeat above steps setting SERVICE MODE to "OFF".

2.2 Service Help

The following websites will help qualified service technicians service and repair heat pump equipment.
Ordering Parts - <https://www.aquacal.com/looking-for-a-part/>

2.3 Adjustments

IN THIS SECTION:

2.3.A Adjusting Water Flow Using ΔT (Delta-T)	48
2.3.B Adjusting Water Pressure Switch (Select Units)	49
2.3.C Three-Phase Adjustment	50

2.3.A Adjusting Water Flow Using ΔT (Delta-T)

The Delta-T is the temperature difference between the water temperatures entering and leaving the heat pump.

The equipment can be fine-tuned for maximum performance by balancing water flow rates to maintain an ideal ΔT .

The adjustment procedure must be completed with the unit in heating mode

PLEASE NOTE -

- The installation of temperature ports is required for all commercial applications.
- The installation of temperature ports is strongly recommended for residential installations.

1. Adjust the thermostat to its lowest setting with the unit in heating mode.
2. Deactivate the water filtration pump.
3. Confirm that the filters leading to the heat pump are clean.
4. Adjust the valves controlling water headed towards the heat pump to the half-open position.
5. Adjust the valves controlling water leading away from the heat pump to a fully open position.
6. Activate the pool water filtration pump.
7. Slowly raise the thermostat temperature until the heat pump activates.
 - After a four-minute delay, the heat pump's compressor will start.
8. With the heat pump running, confirm the filtration pump is operating properly with adequate flow and no short cycling.
9. Wait for water temperatures to stabilize (approximately 5 minutes).
10. Adjust valves in the following order using the temperature chart provided.
 - a. Adjust the valve that controls water exiting the heat pump until the correct temperature differential is achieved. Match the temperature measured with a temperature probe to the chart.
 - b. Wait for water temperatures to stabilize. Then check the temperature again. Re-adjust the valve as needed.
11. Mark valves at these positions for future reference.

**Temperature Port
(Shown with Probe)**



HEAT EXCHANGER TYPE	MODEL	TEMPERATURE
Titanium ThermoLink®	SQ140R	3° to 7° F (1.7° C to 3.9° C)
Titanium ThermoLink®	SQ200R	3° to 8° F (1.7° C to 4.4° C)

HEAT EXCHANGER TYPE	MODEL	TEMPERATURE
Titanium ThermoLink®	TC1000	2° to 5° F (1.1° C to 2.8° C)
Titanium ThermoLink®	TC1500	3° to 7° F (1.7° C to 3.9° C)

Table 1 - Temperature Chart

PLEASE NOTE -

- Temperature differences are based on pool water temperatures of 69° to 75° F. (20.5° to 23.8° C)
- For water temperatures outside this range, contact AquaCal®. See "Contacting AquaCal AutoPilot, Inc."

2.3.B Adjusting Water Pressure Switch (Select Units)

Adjust the water pressure switch when heat pump attempts to operate without water flow.

Before attempting any adjustments confirm the following :

- The filter is clean.
- Filter pump is operating.
- The valves are set to direct the appropriate amount of water through the heat pump. See "*Water Flow Rates*" on page 17.
- "**NO POOL/SPA WATER FLOW**" is displayed (or displays intermittently).

DANGER

Failure to heed the following will result in injury or death.

- Deactivate power while routing wiring to control board.
- Heat Pump equipment must be installed within manufacturer specifications and must follow all National and/or State and Local installation guidelines.
- Follow all National Electric Codes (NEC) and/or State and Local guidelines.

WARNING

Failure to heed the following may result in injury or death.

- Water Pressure Switch adjustment procedure to be performed by experienced service personnel only; procedure must not be attempted by individuals lacking adequate electrical and mechanical experience.

NOTICE

Failure to heed the following may result in damage to equipment.

- If the heat pump continues to operate after a water pressure switch adjustment, deactivate equipment and perform additional troubleshooting.

1. Remove heat pump access panel.
2. Locate the water pressure switch. It will be outside and along the bottom edge of the electrical enclosure. The exact location varies by model.
3. Activate the filter pump.
4. Apply power to heat pump.
5. Slowly rotate the adjustment wheel on the switch. Keep turning the wheel until the heat pump indicates it is receiving water. The display will no longer indicate "**NO POOL/SPA WATER FLOW**".
6. Deactivate filter pump. If correctly adjusted, the heat pump will deactivate and the display will show "**NO POOL/SPA WATER FLOW**".
7. Re-install heat pump access panel.
8. If the heat pump continues to operate without water flow, the installation of a grid flow switch may be required.
 - This can become necessary if the heat pump is installed below the elevation of the body of water to be heated or cooled. The standing pressure from the water can cause the water pressure switch to activate when the circulation pump is off. Therefore a water flow switch must be used in place of a water pressure switch to determine if incoming water is being sent to the heat pump.
9. If the heat pump continues to operate without water flow, contact AquaCal®.

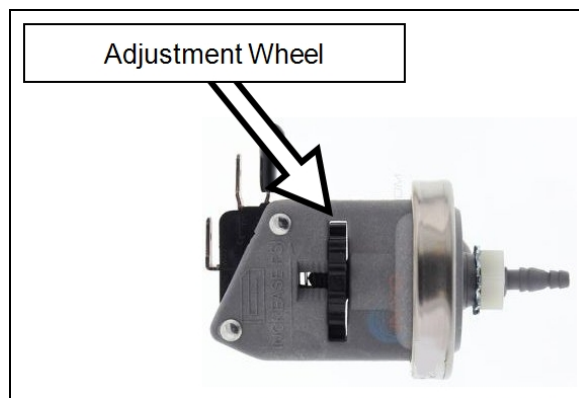

2.3.C Three-Phase Adjustment

⚠ DANGER

Failure to heed the following will result in injury or death.

- Deactivate power while routing wiring to control board.
- Heat Pump equipment must be installed within manufacturer specifications and must follow all National and/or State and Local installation guidelines.
- Follow all National Electric Codes (NEC) and/or State and Local guidelines.

⚠ WARNING

Failure to heed the following may result in injury or death.

- The information contained in this section is intended for use by qualified technicians, familiar with electrical service-industry safety standards and methods.

If a three-phase unit fails to operate at start-up, the orientation of the line voltage "field" wiring may need to be adjusted.

- The phase monitor is located inside the electrical panel.
1. Deactivate power to the unit. **Confirm that power is off to all three legs using an electrical test meter set for the correct voltage.**
 2. If the unit fails to start, disconnect power. Switch any two wires (L1, L2, or L3) at the line side of the contactor. Re-connect power and attempt to restart the unit.
 3. When heat pump starts, disconnect power and verify off. Then confirm all line voltage connections are securely tightened. Reconnect power.
 - If the heat pump does not start, contact AquaCal® for further assistance. See "**Contacting AquaCal AutoPilot, Inc.**".

Three-Phase Monitor

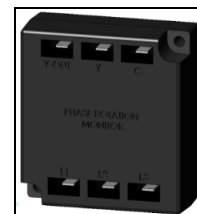

2.4 Defaults

IN THIS SECTION:

2.4.A Equipment Parameters	51
2.4.B Factory Reset	52

2.4.A Equipment Parameters

This section describes all the possible parameters for equipment that can be connected to the heat pump.

Pumps

Parameter	Description
Name	A set of names are provided for easy identification of the circulation pump.
Pump Type	A choice between a variable speed or single speed circulation pump is provided.
Port	This is the connection port where a circulation pump is connected to the heat pump. <ul style="list-style-type: none"> The connection ports are normally "Port B" on the control board for a variable speed circulation pumps. Expansion board replay ports are available ("A" (default), "C", "D", "E", or "F") for single speed pumps. Or a combination of relay ports can be used for multi-speed circulation pumps.
Minimum Speed	The minimum allowed speed for the circulation pump to operate.
Maximum Speed	The maximum allowed speed for the circulation pump to operate.
Priming Time	The amount of time allowed to prime the variable speed circulation pump to remove air bubbles in the lines. Air bubbles would prevent the water from circulating properly in the system.
Priming Speed	The variable speed circulation pump's operating speed when priming the equipment.
Heat / Cool Speed	The speed a variable speed circulation pump must run when actively heating or cooling the water.

Chlorinator

Parameter	Description
Name	A set of labels are provided for easy identification of the chlorination system's connection port on the control board.
Chlorinator Type	CHLORSYNC (<i>ChlorSync</i> TM)
Port	This is the logical ID of the device (default is "BROADCAST"). The device itself would be connected to the heat pump via a PoolSync device on port "D". See " <i>PoolSync® WiFi Controller (PS0001)</i> " on page 54.

2.4.B Factory Reset

A factory reset of all settings can be performed if needed.

This will reset all settings to factory defaults.

PLEASE NOTE:







This action will wipe all previously set configurations such as external controller settings, optional device settings, groups, equipment, schedules, and site specific settings and return the heat pump to its default firmware settings from the factory.

NOTICE

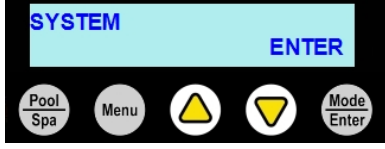
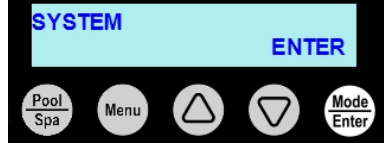
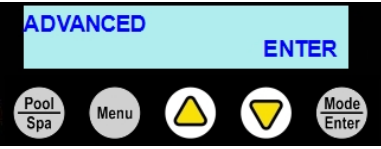
Failure to heed the following may result in damage to equipment.

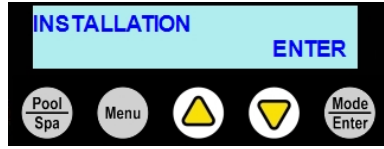
- Any site specific settings entered by the installer will be lost when performing this operation.

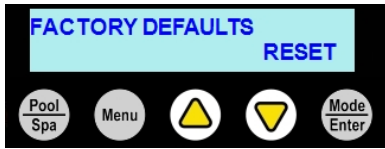
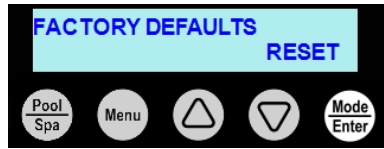
Enter "Installation" menus, then proceed

A PRESS MENU BUTTON 	B USE ARROWS TO "SYSTEM" 	C PRESS "ENTER" 
D USE ARROWS TO "ADVANCED" 	E PRESS "ENTER" 	F USE ARROWS TO "INSTALLATION" 
G PRESS "ENTER" 	1 USE ARROWS TO MENU "FACTORY DEFAULTS" 	2 ENTER TO SELECT 
3 PRESS BUTTON UNDER "YES" TO CONFIRM 		

The system will restart and operate as if no equipment is connected directly to the heat pump.

2.5 Supplemental

IN THIS SECTION:

2.5.A Additional Options	53
2.5.B Available Accessories	53
2.5.C Cleaning Equipment After Installation	55
2.5.D Irrigation and Storm Run-Off	56
2.5.E Initial Cooling Recommendations	56
2.5.F Initial Heating Recommendations	56
2.5.G Saving Installer Settings to USB	57
2.5.H Use Installer Settings from USB	58
2.5.I Site Configuration Presets (Optional)	59
2.5.J Standards	61
2.5.K FCC Compliance	62
2.5.L Winterizing	62

2.5.A Additional Options

Additional product option advice is available online in the options manuals.

<https://www.aquacal.com/hp11-options-manuals/>

This includes the following:

- Circulation pump control,
- Solar control,
- Using External Controllers,
- Installing expansion boards,
- Connecting relays and actuators, using installation presets, and setting up groups and schedules.

2.5.B Available Accessories

Accessories may be purchased through an authorized dealer of AquaCal® products.

Bypass Valve Kit (# STK0135)

- When high flow rates are outside recommended specifications, please use this kit or an alternative bypass valve system.
- This kit can be used to control excessive water flow through the heat pump. It provides automatic flow adjustments for most applications.



Condensation Drain Kit (# STK0202)

- Used when condensation water flow must be directed to a specific location.



Expansion Board Upgrade Kit (# STK0271)

- This kit contains an upgrade board that will give the heat pump direct control of actuators, circulation pumps, and relay-controlled devices.

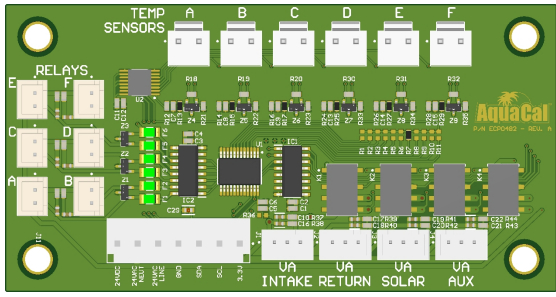

Liquid Blankets

- An invisible liquid heat barrier designed to retain heat and extend the swimming season.
- AquaCal® recommends [Lo-Chlor®](#) Aqua Blanket™.



Plumbing Unions

- 2 Inch Unions - (# PLS2627)



PoolSync® WiFi Controller (PS0001)

- This kit will add WiFi control capabilities to heat pumps without the WiFi feature already equipped on the unit.
- Contact installing dealer to order this product.



Temperature Port Kit (# STK0096)

- This port can be used to adjust water flow using Delta-T.
- The kit comes with port, installation components, and a temperature probe.



2.5.C Cleaning Equipment After Installation

Installer - If you need to clean the equipment after installation, please use the following guidelines.

WARNING

Failure to heed the following may result in injury or death.

- Possible electric shock hazard - Deactivate power to all electrical devices on the pad when washing heat pump. Do not restore electrical power until equipment is completely dry.

NOTICE

Failure to heed the following may result in damage to equipment.

- Do not use a pressure cleaner to wash the heat pump. Damage to heat pump components may result. If using a hose-end spray nozzle adjust the spray pattern to low strength only.
- Do not spray water directly into the interior of the heat pump; damage to components may result.
- Do not use chemicals on the display panel.

Cleaning

1. Wash cabinet using a low-pressure water hose. A high-pressure water stream will cause damage to the aluminum fins of the heat pump. This damage is not covered under the product warranty.
2. While the heat pump is still wet, use an approved cleaning agent to clean the exterior of the heat pump. **Do not use chemicals on the display panel.**
3. Use a detergent-dampened cloth to wipe the heat pump's exterior cabinet.
4. Flush all exterior with fresh water using a low-pressure water hose.
5. Dry the cabinet using a soft cloth being careful not to damage fins.

APPROVED CLEANING AGENTS*

Fantastic®

Formula 409®

Cascade®

All Power Plain Detergent (3% Solution)

Table 2 - Cleaning Agents

- * The trademarks used in approved cleaning agents are the property of their owners and are not related to AquaCal®.

Polishing

1. Polish the heat pump's cabinet panels using an approved polishing agent and following the manufacturer's instructions. **Do not use chemicals on the display panel.**
2. Rinse the heat pump panels with fresh water, wipe, and buff panels using a dry soft cloth.
3. Allow heat pump interior and surrounding equipment to "air-dry" for several hours prior to restoring electrical power.

APPROVED POLISHING AGENTS*

Simoniz® Wax

Glo-Coat®

Armor All® Protectant

Table 3 - Polishing Agents

- * The trademarks used in approved polishing agents are the property of their owners and are not related to AquaCal®.

2.5.D Irrigation and Storm Run-Off

- Irrigation water may damage heat pump components. Direct irrigation water away from the heat pump.
- The heat pump will withstand normal rainfall. Do not allow a roof slope to direct rainwater onto the heat pump. Have a gutter installed on the roof edge to direct this water away from the heat pump. Or install the heat pump in another location.

2.5.E Initial Cooling Recommendations

The following recommendations will reduce the amount of time required to cool a pool. **If unsure of equipment cooling capability, review equipment data plate.** See "Identifying Model Specifications".

1. Confirm the valves are turned to the correct body of water.
2. Set the pool time clock to 24 hour operation.
3. Confirm the mode has been set to "COOL" mode.
4. Set the desired temperature "COOL SETPOINT" for the water.
5. After the desired temperature has been reached, reset circulation pump time clock to normal time frame.

2.5.F Initial Heating Recommendations

The following recommendations will reduce the amount of time required to heat a pool. **If unsure of equipment heating capability, review equipment data plate.** See "Identifying Model Specifications".

NOTE

Using a pool blanket or liquid blanket can allow the water to retain heat and have quicker heating times.

1. Confirm the valves are turned to the correct body of water.
2. Set the pool time clock to 24 hour operation.
3. Confirm the mode has been set to "HEAT" mode.
4. Set the desired temperature "HEAT SETPOINT" for the water.
5. After the desired temperature has been reached, reset circulation pump time clock to normal time frame.

2.5.G Saving Installer Settings to USB

Heat Pump settings can be saved to a USB thumb drive for later usage. This is particularly helpful to an installer that uses the same equipment and configurations on future installations.

DANGER

Failure to heed the following will result in injury or death.

- Deactivate power while routing wiring to control board.
- Heat Pump equipment must be installed within manufacturer specifications and must follow all National and/or State and Local installation guidelines.
- Follow all National Electric Codes (NEC) and/or State and Local guidelines.

Steps to save configuration to a thumb drive:

1. Deactivate power to heat pump.
2. Remove heat pump's electrical access panel.
3. Plug USB thumb drive into port as indicated. See Figure 1.
4. Activate power to heat pump. Do not touch thumb drive or electrical components inside heat pump. A risk of electrical shock can occur resulting in injury or death.
5. Navigate to "SAVE SETUP TO USB" in the installer menu.
6. Perform save to thumb drive operation.

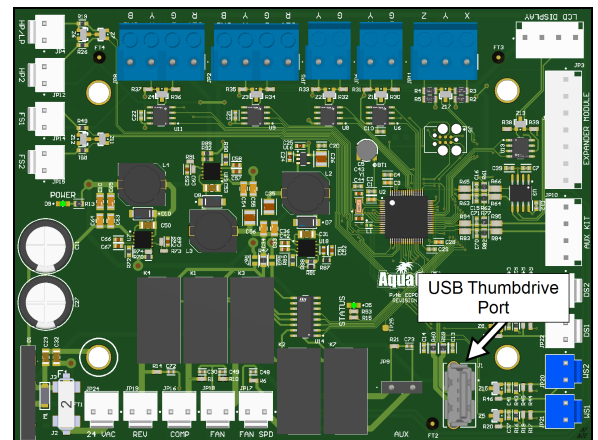

Figure 1 - USB Thumb Drive Port

<p>A PRESS MENU BUTTON</p>	<p>B USE ARROWS TO "SYSTEM"</p>	<p>C PRESS "ENTER"</p>
<p>D USE ARROWS TO "ADVANCED"</p>	<p>E PRESS "ENTER"</p>	<p>1 USE ARROWS TO MENU "SAVE SETUP TO USB"</p>
<p>2 PRESS "ENTER"</p>	<p>3 DISPLAY WILL SHOW "SAVING...", THEN "DONE"</p>	<p>MENU TO EXIT, PRESS & HOLD TO STATUS</p>

7. Deactivate power to heat pump.
8. Remove thumb drive and label for future usage.
9. Reinstall heat pump's electrical access panel.

The USB drive can now be used to set heat pump configurations on other heat pumps.

2.5.H Use Installer Settings from USB

A file, previously saved onto a USB thumb drive, can be used to configure the heat pump. See "Saving Installer Settings to USB" on the previous page.

PLEASE NOTE:
 This file will take advantage of any custom configurations entered by the installer on prior installations. The file will contain the equipment, group, and schedule settings. Other settings such as multi-unit installations, etc. will still need to be configured.

⚠ DANGER

Failure to heed the following will result in injury or death.

- Deactivate power while routing wiring to control board.
- Heat Pump equipment must be installed within manufacturer specifications and must follow all National and/or State and Local installation guidelines.
- Follow all National Electric Codes (NEC) and/or State and Local guidelines.

1. Turn off power at heat pump's power disconnect.
2. Remove heat pump electrical access panel.
3. Place USB thumb drive in the heat pump's USB thumb drive port on the control board. See Figure 2.
4. Activate power to heat pump. Do not touch thumb drive or electrical components inside heat pump. Risk of electrical shock can result in injury or death.
5. Navigate to "USE PRESET FROM USB" in the installer menus.
6. Perform restore from USB operation.

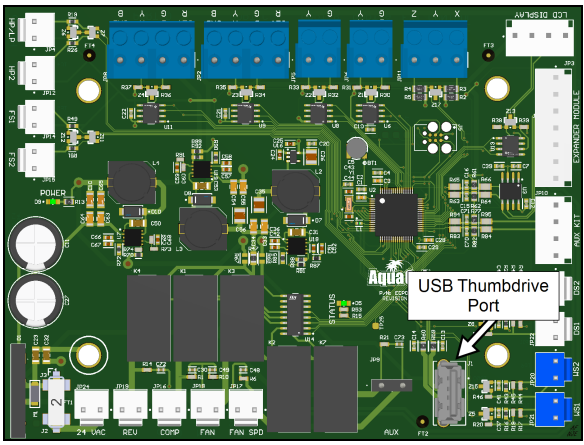
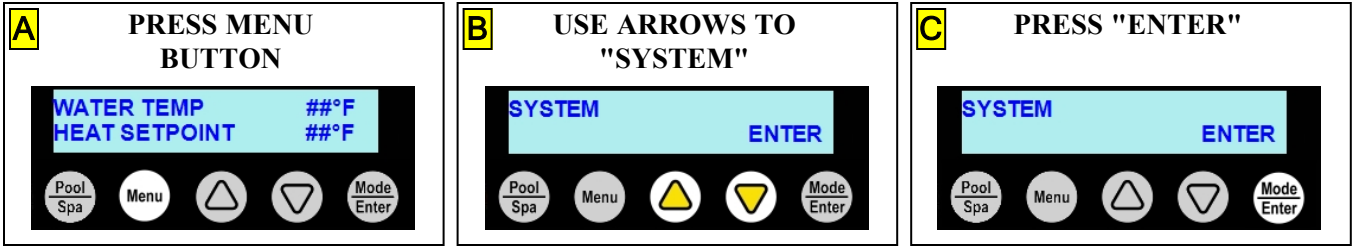
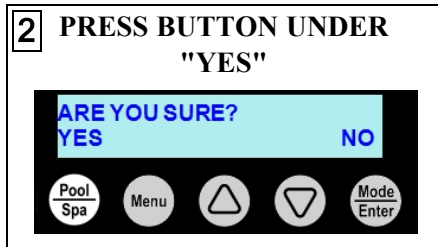
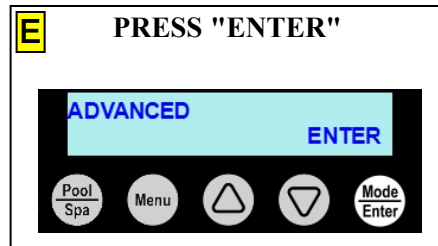
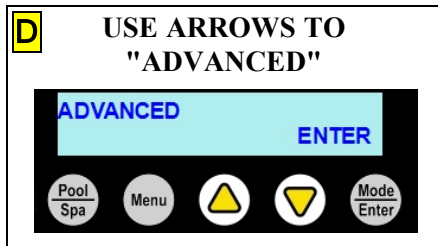

Figure 2 - USB Thumb Drive Port





7. After heat pump has successfully loaded file and restarted, deactivate heat pump at power breaker.
8. Remove thumb drive.
9. Reinstall heat pump's access panel.

2.5.I Site Configuration Presets (Optional)

A list of site configurations (presets) can be used to easily configure equipment directly connected to the heat pump. Connected equipment, such as a circulation pump for example, can have all the necessary options automatically set to operate the device.

NOTE

The standard (from the factory) heat pump **does not use** groups or schedules. These can be created as needed depending on if a heat pump option has been utilized. See [Product Manual Options](#) for more information on available options.

NOTICE

Failure to heed the following may result in damage to equipment.

- Any existing programs or settings will be cleared and replaced with the chosen preset option. If this is undesired, then press the button under "SKIP" to exit the menu and set up equipment manually.
- After using a preset, values such as system RPMs should be checked to confirm they do not exceed system requirements. Damage to equipment due to excessive water flow, from setting RPMs too high, is not covered under factory warranties.

NOTE

After using a preset, any setting can be manually customized (or fine tuned) by the installer. Values, such as circulation pump RPMs, should be checked to confirm they do not exceed system requirements.

ALSO NOTE

- If necessary, the system can be set to factory default if an incorrect preset has been used. See "Factory Reset" on page 52.
- If a third-party external controller was used prior to upgrading the system, a factory reset will be required to see all presets. See "Factory Reset" on page 52.
- If the PoolSync® external controller was used prior to upgrading the system, all applicable heat pump presets will be shown.

Navigate to the installation menus to access these preset configurations.

Enter "Installation" menus, then proceed

A PRESS MENU BUTTON
WATER TEMP ##°F
HEAT SETPOINT ##°F
Buttons: Pool/Spa, Menu, Up, Down, Mode/Enter

B USE ARROWS TO "SYSTEM"
SYSTEM ENTER
Buttons: Pool/Spa, Menu, Up, Down, Mode/Enter

C PRESS "ENTER"
SYSTEM ENTER
Buttons: Pool/Spa, Menu, Up, Down, Mode/Enter

D USE ARROWS TO "ADVANCED"
ADVANCED ENTER
Buttons: Pool/Spa, Menu, Up, Down, Mode/Enter

E PRESS "ENTER"
ADVANCED ENTER
Buttons: Pool/Spa, Menu, Up, Down, Mode/Enter

F USE ARROWS TO "INSTALLATION"
INSTALLATION ENTER
Buttons: Pool/Spa, Menu, Up, Down, Mode/Enter

G PRESS "ENTER"
INSTALLATION ENTER
Buttons: Pool/Spa, Menu, Up, Down, Mode/Enter

Select the appropriate preset for the site conditions.

PRESET OPTIONS:

Pool / Spa, No Pump	61
Pool Only, No Pump	61
Spa Only, No Pump	61

Pool / Spa, No Pump

**POOL/SPA
NO PUMP** **SELECT**

This preset configures the heat pump as follows:

- No circulation pump is configured.
- No schedules are configured.

When pressed, the "Pool/Spa" button will display with three choices:

1. Pool - With an initial timer set for 48 hours at 85° F.
2. Spa - With an initial timer of 2 hours at 104° F.
3. Schedules - Without an active schedule, the heat pump mode is initially set to "OFF".

Pool Only, No Pump

**POOL ONLY
NO PUMP** **SELECT**

This preset configures the heat pump as follows:

- No circulation pump is configured.
- No schedules are configured.

When pressed, the "Pool/Spa" button will display with two choices:

1. Pool - With an initial timer set for 48 hours at 85° F.
2. Schedules - Without an active schedule, the heat pump mode is initially set to "OFF".

Spa Only, No Pump

**SPA ONLY
NO EQUIPMENT** **SELECT**

This preset configures the heat pump as follows:

- No circulation pump is configured.
- No schedules are configured.

When pressed, the "Pool/Spa" button will display with two choices:

1. Spa - With an initial timer of 2 hours at 104° F.
2. Schedules

2.5.J Standards

Conforms To

UL STD 1995:2015 Ed. 4+R:03Oct2014, 60335-2-40:2019 Ed. 3, 60335-1:2016 Ed. 6

Certified To

CSA STD C22 .2#236:2011 Ed. 4, .2#60335-2-40:2019 Ed. 3, C22.2#60335-1:2016 Ed. 2

2.5.K FCC Compliance

NOTE

Changes or modifications not expressly approved by the party responsible for compliance could void the user's authority to operate the equipment.

This device has been tested and complies with part 15 of the FCC rules. Operation is subject to the following two conditions

1. This device may not cause harmful interference, and
2. This device must accept any interference received, including interference that may cause undesired operation.

These limits are designed to provide reasonable protection against harmful interference in a residential installation. This equipment generates, uses and can radiate radio frequency energy and, if not installed and used in accordance with the instructions, may cause harmful interference to radio communications. However, there is no guarantee that interference will not occur in a particular installation. If this equipment does cause harmful interference to radio or television reception, which can be determined by turning the equipment off and on, the user is encouraged to try to correct the interference by one or more of the following measures:

- Reorient or relocate any connected PoolSync®'s receiving antenna.
- Increase the separation between the equipment and any connected PoolSync®'s receiver.
- Connect the equipment into an outlet on a circuit different from that to which the receiver is connected.
- Consult the dealer or an experienced radio / TV technician for help.

2.5.L Winterizing

Failure to properly winterize the heat pump as needed may result in serious equipment damage.

⚠ DANGER

Failure to heed the following will result in injury or death.

- Deactivate power while routing wiring to control board.
- Heat Pump equipment must be installed within manufacturer specifications and must follow all National and/or State and Local installation guidelines.
- Follow all National Electric Codes (NEC) and/or State and Local guidelines.

⚠ WARNING

Failure to heed the following may result in injury or death.

- Deactivate all electrical power to heat pump before performing hard freeze procedures.

NOTICE

Failure to heed the following may result in damage to equipment.

- Failure to winterize heat pump may result in serious equipment damage. Freeze damage is not covered under the heat pump warranty.
- While the plumbing connections are in the winterized condition (not fully tightened), it is imperative that water not run through the heat pump. Loss of water through loose plumbing connections may result in damage to circulation pump, pool and spa structures, and other equipment.

Light Freeze Conditions

A light freeze is when the ambient air temperature falls below 32 degrees Fahrenheit (0° C) for less than 8 hours. Typically during light freeze conditions circulating (or moving) water will not freeze. Temporarily activate the filter pump for continuous operation during light freeze conditions. If the heat pump is directly controlling a water circulation pump, any groups marked as requiring freeze protection will automatically have water circulated to the equipment. See "*Freeze Protection*" on page 36.

Hard Freeze Conditions

A hard freeze is when the ambient air temperature falls below 32 degrees Fahrenheit (0° C) for more than 8 hours. In areas where this condition is prevalent and sustained, the heat pump **MUST** be winterized for hard freeze conditions. Follow the correct procedure depending on the type of heat exchanger found in the heat pump.

Titanium ThermoLink[®] Exchanger (with no Drain)

1. Disconnect the plumbing to the heat pump at connection unions (removal is counter-clockwise).
2. Allow water to drain completely from the heat pump. Expect to see a lot of water drain out at first, and then a small amount to continue to drain out over a long period.
3. After heat pump has fully drained, loosely reconnect plumbing connection unions.
4. Winterizing is complete.
5. When ready to use the heat pump again, hand-tighten connection unions. Reconnect electrical power, and set the operating mode on the heat pump. Activate the filter pump.

No Drain

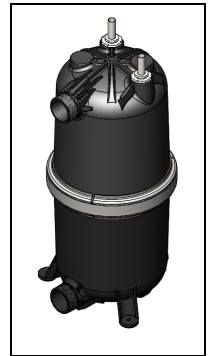

2.6 System Information

IN THIS SECTION:

2.6.A Dimensions	64
2.6.B Identifying Model Specifications	64
2.6.C Viewing System Information	65
2.6.D Viewing MAC Address (Configured WiFi Only)	66
2.6.E Weights	66

2.6.A Dimensions

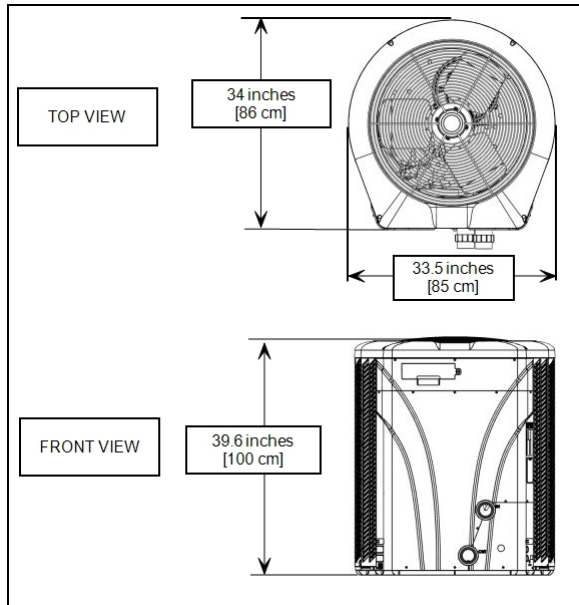

HeatWave SuperQuiet® SQ140R, and
SQ200R

TropiCool® TC1000 TC1500

2.6.B Identifying Model Specifications

1. Find Data Plate - The data plate is usually posted on the side of the equipment or the inside of the heat pump's access plate.
2. Find the model number on the data plate. The first letters and numbers indicate the model type.
3. The complete model number identifies the equipment's specifications.

Data Plate Example

MINIMUM CIRCUIT AMPACITY	<input type="text"/>	MADE IN THE USA
ELEC. SERVICE: VOLTS	<input type="text"/>	PH <input type="text"/> HZ <input type="text"/>
MAXIMUM TIME DELAY FUSE OR HACR BREAKER	<input type="text"/>	5
COMPRESSOR VOLTS	<input type="text"/>	R.L.A. <input type="text"/> L.R.A. <input type="text"/>
FAN MOTOR VOLTS	<input type="text"/>	H.P. <input type="text"/> F.L.A. <input type="text"/>
REFRIGERANT: Circuit - Factory charged	<input type="text"/>	Only oz/Kg <input type="text"/>
Tested to	<input type="text"/> psig High side /	<input type="text"/> psig Low side
OUTDOOR UNIT		
AQUA CAL, INC A TEAM HORNER COMPANY 2737 24 TH STREET NORTH ST. PETERSBURG, FL 33713 FACTORY SERVICE 727-523-5642	MODEL NUMBER <input type="text"/>	IIIBAR CODEIII
	SERIAL NUMBER <input type="text"/>	IIIBAR CODEIII

Model Number Example

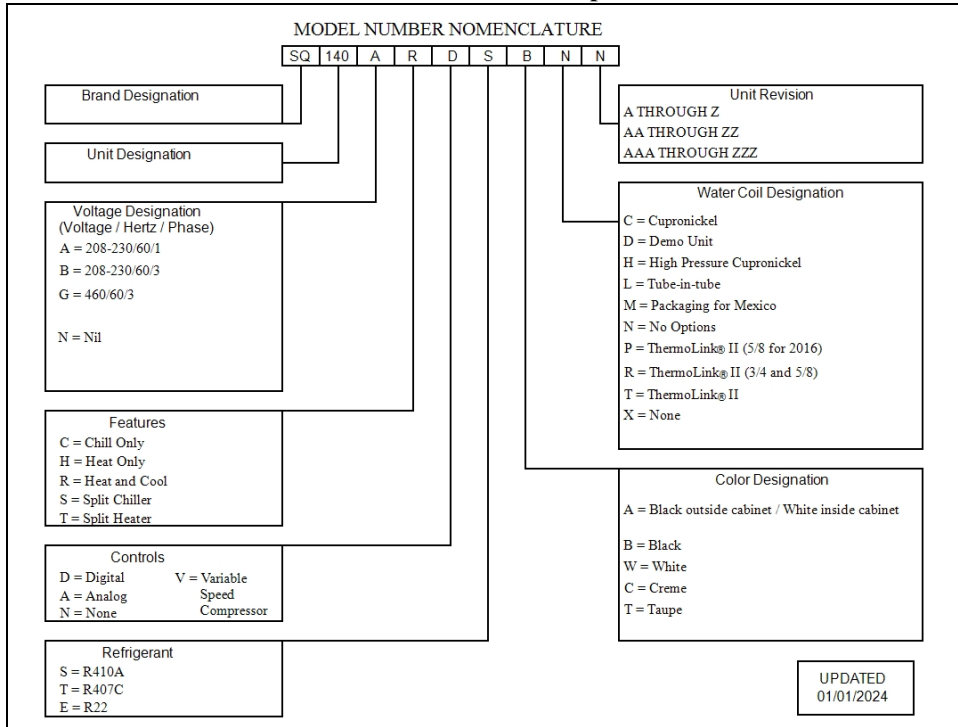

2.6.C Viewing System Information

The heat pump model, serial number, and firmware version can be viewed in the information menus.

Enter "System" menus, then proceed

A **PRESS MENU BUTTON**

B **USE ARROWS TO "SYSTEM"**

C **PRESS "ENTER"**

1 **USE ARROWS TO MENU "INFORMATION"**

2 **PRESS ENTER TO VIEW**

3 **USE ARROWS TO VIEW "UNIT SERIAL NUMBER"**

4 **USE ARROWS TO VIEW "UNIT MODEL NUMBER"**



5 **USE ARROWS TO VIEW "FIRMWARE VERSION"**

MENU TO EXIT, PRESS & HOLD TO STATUS

2.6.D Viewing MAC Address (Configured WiFi Only)

If WiFi has been enabled, the Heat Pump's MAC address can be viewed in the PoolSync[®] menus.

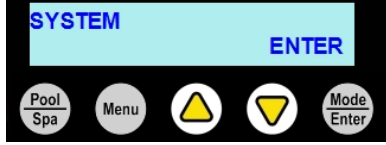
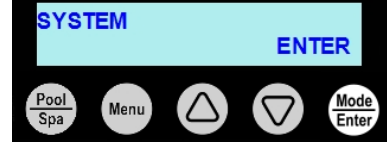
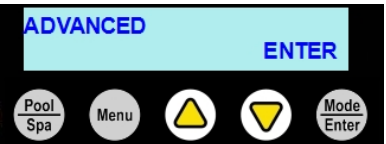
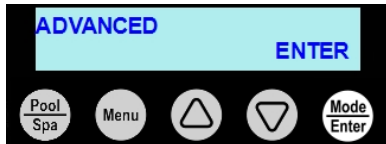
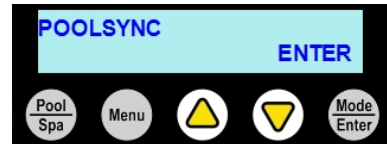
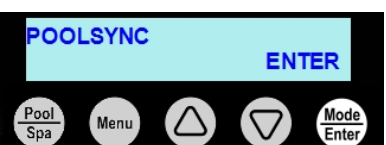
Enter "Advanced" menus, then proceed

<p>A PRESS MENU BUTTON</p> 	<p>B USE ARROWS TO "SYSTEM"</p> 	<p>C PRESS "ENTER"</p> 
<p>D USE ARROWS TO "ADVANCED"</p> 	<p>E PRESS "ENTER"</p> 	<p>1 USE ARROWS TO MENU "POOLSYNC"</p> 
<p>2 SELECT ENTER</p> 	<p>3 USE ARROWS TO VIEW "MAC ADDRESS"</p> 	<p>MENU TO EXIT, PRESS & HOLD TO STATUS</p> 

2.6.E Weights

NOTE:

Specifications subject to change.

Model Type	Model Number	Install Weight
HeatWave SuperQuiet [®]	SQ140R	268 Pounds (121.6 kg)
HeatWave SuperQuiet [®]	SQ200R	328 Pounds (148.8 kg)
TropiCool [®]	TC1000	285 Pounds (128.8 kg)
TropiCool [®]	TC1500	328 Pounds (148.8 kg)

3 - Troubleshooting



DANGER

Failure to heed the following will result in injury or death.

- Deactivate power while routing wiring to control board.
- Heat Pump equipment must be installed within manufacturer specifications and must follow all National and/or State and Local installation guidelines.
- Follow all National Electric Codes (NEC) and/or State and Local guidelines.



WARNING

Failure to heed the following may result in injury or death.

- Repairs must not be attempted by untrained or unqualified individuals.
- The heat pump contains refrigerant under high pressure. Repairs to the refrigerant circuit must not be attempted by untrained or unqualified individuals. Service must be performed only by qualified HVAC technicians. Recover refrigerant before opening the system.

NOTICE

Failure to heed the following may result in damage to equipment.

- Service by unauthorized personnel will void the heat pump warranty.

IN THIS SECTION:**Fault Codes**

AQUASTAR VS PUMP FAULT	69
COMPRESSOR LOCKOUT	69
DEFROST1 SENSOR OPEN or DEFROST2 SENSOR OPEN	69
DEFROST1 SENSOR SHORT or DEFROST2 SENSOR SHORT	69
ERROR AT PRIMARY UNIT	69
HAYWARD VS PUMP FAULT	70
HIGH PRESSURE FAULT	70
HIGH WATER TEMP	71
HP5 SYSTEM LOCKOUT	71
HPC TEMP SYSTEM LOCKOUT	71
JANDY VS PUMP FAULT	71
LOW PRESSURE FAULT	72
LP5 SYSTEM LOCKOUT	72
MULTIPLE PRIMARY FAULT	73
MULTI-UNIT COMM FAULT	73
NO CONTROLLER COMM	73
OTA SYSTEM LOCKOUT	73
PENTAIR VS PUMP FAULT	74
SMART COMM FAULT	74
STA-RITE VS PUMP FAULT	74
VGREEN VS PUMP FAULT	74
WATER TEMP1 SENSOR SHORT or WATER TEMP1 SENSOR OPEN	75
WATER TEMP2 SENSOR SHORT or WATER TEMP2 SENSOR OPEN	75

Issues and resolutions

Blank Display	76
Circulation Pump Won't Activate	76
Display Panel Not Responding	76
Displays "DEFROSTING"	77
Displays "FREEZE PROTECTION ACTIVE"	77
Displays "NO SYSTEM FIRMWARE"	78
Displays "NO POOL/SPA WATER FLOW"	78
Displays "NO POOL/SPA GROUP EXISTS "	
Displays "POOLSYNC NO WIFI"	79
Displays "POOLSYNC NO CLOUD"	79
Displays "POOLSYNC NOT DETECTED"	79
Displays "POOLSYNC SERVICE ACCESS"	80
Displays "POOLSYNC SETUP MODE"	80
Displays "SET TO SWITCH REMOTELY"	80
Displays "UNIT MODEL NUMBER"	80
Heat Pump Not Running	81
Heat Pump's Tripping Breaker	81
Heat Pump Won't Shut Off	81
Heat Pump Is Running, Not Heating	82
Heat Pump Is Running, Not Cooling	82
Ice Forming on the Heat Pump	83
"Pool / Spa" Button Isn't Working	84
Schedule Not Working	84
Water Coming From Heat Pump	85

3.1 Fault Codes

A fault code indicates a specific issue or condition that will require action before the equipment can resume operating.

Please perform the following troubleshooting.

If the issue reoccurs, please contact AquaCal. See "*Contacting AquaCal AutoPilot, Inc.*" on page 1.

AQUASTAR VS PUMP FAULT

ISSUE

The heat pump has either lost communication with a connected Aquastar circulation pump. Or the Aquastar pump needs attention.

RESOLUTION

Check wiring between pump and unit for breaks or damage.

Reset the heat pump and circulation pump power breakers to potentially clear any internal pump faults.

Check circulation pump documentation for further troubleshooting advice on that equipment.

COMPRESSOR LOCKOUT

ISSUE

The compressor has failed to start properly and has gone into protection mode.

RESOLUTION

Service by an HVAC qualified technician is required.

DEFROST1 SENSOR OPEN or DEFROST2 SENSOR OPEN

ISSUE

Open defrost sensor.

RESOLUTION

A qualified technician should replace the defrost sensor.

DEFROST1 SENSOR SHORT or DEFROST2 SENSOR SHORT

ISSUE

Shorted defrost sensor.

RESOLUTION

A qualified technician should replace the defrost sensor.

ERROR AT PRIMARY UNIT

ISSUE

The heat pump is secondary to a primary heat pump that is displaying a fault code.

RESOLUTION

The error at the primary heat pump must be corrected before the secondary unit will resume operation.

HAYWARD VS PUMP FAULT

ISSUE

The heat pump has either lost communication with a connected Hayward circulation pump. Or the Hayward pump needs attention.

RESOLUTION

Check wiring between pump and unit for breaks or damage.

Reset the heat pump and circulation pump power breakers to potentially clear any internal pump faults.

Check circulation pump documentation for further troubleshooting advice on that equipment.

HIGH PRESSURE FAULT

ISSUE

The refrigerant system's high-pressure switch is showing as open.

RESOLUTION

Heat Only Units

Determine if the proper amount of water flow is being provided to the equipment.

1. Confirm the filter pump is on.
2. If a multiple-speed filter pump is being used, run filter pump at a higher speed. Do not exceed the maximum flow rate for the model.
3. Confirm water is not being diverted away from the heat pump.
 - See "*Water Flow Rates*" on page 17.
 - See "*Adjusting Water Flow Using ΔT (Delta-T)*" on page 48.

Cool Only Units

Determine if there is a proper air circulation around the equipment.

1. Check for proper fan operation. If the fan is not operating, contact AquaCal® Technical Support.
2. Check for obstructed airflow around the heat pump.
 - See "*Clearances*" on page 6.
3. Check for a dirty or blocked evaporator coil.
 - See "*Cleaning Equipment After Installation*" on page 55.

Heat and Cool Units (Reversing)

Place heat pump in heating mode and perform the following troubleshooting.

Determine if the proper amount of water flow is being provided to the equipment.

1. Confirm the filter pump is on.
2. If a multiple-speed filter pump is being used, run filter pump at a higher speed. Do not exceed the maximum flow rate for the model.
3. Confirm water is not being diverted away from the heat pump.
 - See "*Water Flow Rates*" on page 17.
 - See "*Adjusting Water Flow Using ΔT (Delta-T)*" on page 48.

HIGH WATER TEMP

ISSUE

Incoming water temperature has exceeded 108° F (42° C) and the unit has been deactivated. The heat pump will not operate until the incoming water temperature drops to 100° F (38° C) or lower.

RESOLUTION

1. Determine if a gas heater is sending water directly to the heat pump. This situation would need to be corrected before continuing.
2. If a solar panel system sends water directly to the heat pump (a normal system), this fault can initially arise until water temperature normalizes.
3. If the **HIGH WATER TEMP** fault continues to display, the water temperature sensor may require replacement.

HP5 SYSTEM LOCKOUT

ISSUE

The heat pump has locked due to five high-pressure faults during one call for heating or cooling.

RESOLUTION

1. Deactivate then reactivate power to the heat pump to clear error.
2. Troubleshoot the high-pressure issue causing the error.
 - See "*HIGH PRESSURE FAULT*" on the previous page.

HPC TEMP SYSTEM LOCKOUT

ISSUE

The heat pump's controller board is overheating.

RESOLUTION

A qualified technician should be contacted to correct the issue.

JANDY VS PUMP FAULT

ISSUE

The heat pump has either lost communication with a connected Jandy circulation pump. Or the Jandy pump needs attention.

RESOLUTION

Check wiring between pump and unit for breaks or damage.

Reset the heat pump and circulation pump power breakers to potentially clear any internal pump faults.

Check circulation pump documentation for further troubleshooting advice on that equipment.

LOW PRESSURE FAULT

ISSUE

The refrigerant system's low-pressure switch is showing as open.

RESOLUTION

Heat Only Units

1. Check for proper fan operation. If the fan is not operating, contact AquaCal® Technical Support.
2. Check for obstructed airflow around the heat pump.
 - See "*Clearances*" on page 6.
3. Check for a dirty or blocked evaporator coil.
 - See "*Cleaning Equipment After Installation*" on page 55.
4. Check for signs of heavy ice buildup on the coil.

Cool Only Units

Determine if the proper amount of water flow is being provided to the equipment.

1. Confirm the filter pump is on.
2. If a multiple-speed filter pump is being used, run filter pump at a higher speed. Do not exceed the maximum flow rate for the model.
3. Confirm water is not being diverted away from the heat pump.
 - See "*Water Flow Rates*" on page 17.
 - See "*Adjusting Water Flow Using ΔT (Delta-T)*" on page 48.

Heat and Cool Units (Reversing)

Place heat pump in heating mode and perform the following troubleshooting.

1. Check for proper fan operation. If the fan is not operating, call for service.
2. Check for obstructed airflow around the heat pump.
 - See "*Clearances*" on page 6.
3. Check for a dirty or blocked evaporator coil.
 - See "*Cleaning Equipment After Installation*" on page 55.
4. Check for signs of heavy ice buildup on the coil.

LP5 SYSTEM LOCKOUT

ISSUE

The heat pump has locked due to five low-pressure faults during one call for heating or cooling.

RESOLUTION

1. Deactivate then reactivate power to the heat pump to clear error.
2. Troubleshoot the low-pressure issue causing the error.
 - See "*LOW PRESSURE FAULT*" above.

MULTIPLE PRIMARY FAULT

ISSUE

If more than one heat pump is set as Primary in a multiple heat pump configuration, the primary units can compete for control of the secondaries, causing them to chatter on / off.

RESOLUTION

1. Verify that only one heat pump is set up as a "PRIMARY" unit in a multiple heat pump configuration.

MULTI-UNIT COMM FAULT

ISSUE

Secondary heat pump is not receiving a signal from the primary heat pump.

RESOLUTION

1. Confirm the primary heat pump is operating correctly. If, for example, no power is supplied to the primary heat pump, an error will appear on the secondary heat pumps.
2. Confirm the heat pump is properly connected and configured to a primary unit.

NO CONTROLLER COMM

ISSUE

The heat pump is unable to communicate with the display board.

RESOLUTION

1. Power cycle the heat pump at the breaker panel.
2. If this does not resolve the issue, a qualified technician should verify the connection between the control board and the display (loose or disconnected cable, crimps in the cable, etc.).
3. If the issue reoccurs, please contact AquaCal. See "*Contacting AquaCal AutoPilot, Inc.*" on page 1.

OTA SYSTEM LOCKOUT

ISSUE

The water has surpassed a safe temperature level. The heat pump has deactivated.

- One of two water temperature sensors may be out of calibration or have failed. Both sensors must be within a certain temperature range.
- The water temperature may have exceeded 110° F.

RESOLUTION

Call for service.

PENTAIR VS PUMP FAULT**ISSUE**

The heat pump has either lost communication with a connected Pentair water pump. Or the Pentair pump needs attention.

RESOLUTION

Check wiring between pump and unit for breaks or damage.

Reset the heat pump and circulation pump power breakers to potentially clear any internal pump faults.

Check circulation pump documentation for further troubleshooting advice on that equipment.

SMART COMM FAULT**ISSUE**

Heat Pump is not receiving a signal from an external controller using a smart connection point.

RESOLUTION

1. Confirm a smart external controller is being used.
 - If not, set external controller mode to "none" instead of "SMART".
2. Confirm connection points from the external controller to the heat pump are correctly configured.
3. If using a smart external controller, confirm the controller is correctly set to send signals to the heat pump. See manuals or guides provided with the external controller.

STA-RITE VS PUMP FAULT**ISSUE**

The heat pump has either lost communication with a connected Sta-Rite water pump. Or the Sta-Rite pump needs attention.

RESOLUTION

Check wiring between pump and unit for breaks or damage.

Reset the heat pump and circulation pump power breakers to potentially clear any internal pump faults.

Check circulation pump documentation for further troubleshooting advice on that equipment.

VGREEN VS PUMP FAULT**ISSUE**

The heat pump has either lost communication with a connected VGreen circulation pump. Or the VGreen pump needs attention.

RESOLUTION

Check wiring between pump and unit for breaks or damage.

Reset the heat pump and circulation pump power breakers to potentially clear any internal pump faults.

Check circulation pump documentation for further troubleshooting advice on that equipment.

WATER TEMP1 SENSOR SHORT or WATER TEMP1 SENSOR OPEN

ISSUE

Open or shorted water sensor.

RESOLUTION

A qualified technician should replace the water sensor. Until the sensor is replaced, the setpoint is limited to 96° F (35.5° C)

WATER TEMP2 SENSOR SHORT or WATER TEMP2 SENSOR OPEN

ISSUE

Open or shorted water sensor.

RESOLUTION

A qualified technician should replace the water sensor. Until the sensor is replaced, the setpoint is limited to 96° F (35.5° C)

3.2 Issues and Resolutions

Please perform the following troubleshooting.

For further assistance, please contact AquaCal. See "Contacting AquaCal AutoPilot, Inc."

Blank Display

ISSUE

The Heat Pump may have an incoming power problem.

RESOLUTION

Confirm electrical power is being supplied to the heat pump from electrical disconnect(s).

Circulation Pump Won't Activate

ISSUE

A circulation pump controlled by the heat pump will not activate as needed.

RESOLUTION

1. Confirm circulation pump is receiving power.
2. Reset circulation pump power breaker to allow internal pump faults to clear.
3. Confirm circulation pump is included in any group that requires it. See options manuals for help on using circulation pumps and creating groups.
4. Confirm the group containing the circulation pump has an appropriate schedule. See options manuals for help on using circulation pumps and creating schedules.
5. Confirm the schedule mode is set to "AUTO" and the scheduled program mode is set to "ON". See "*Schedule and Program Modes*" on page 41.

Display Panel Not Responding

ISSUE

The heat pump's display panel will not respond to user input.

RESOLUTION

1. If heat pump display shows "**UNDER REMOTE CONTROL**", use the external control device to control the heat pump.
2. If needed, check with the external controller manufacturer for further assistance using that device.

Displays "DEFROSTING"**ISSUE**

The heat pump has sensed the coil is icing up. See "*Ice Forming on the Heat Pump*" on page 83. No action is required.

RESOLUTION**Heat Only Units - Passive Defrost**

When ice starts to form on the coil, the compressor will stop operating while the fan continues to operate.

- The coil will begin to warm to the surrounding air temperature. When the coil's temperature rises above 38° F (3.3° C), the compressor is restarted and heating resumes.
- If the coil's temperature remains below 38° F (3.3° C), the compressor will remain off.

Heat and Cool Units - Active Defrost

Hot refrigerant gas will be sent through the coil to rapidly remove ice or frost.

During this process, the melting of the ice may appear as steam coming off the heat pump. This is normal.

Displays "FREEZE PROTECTION ACTIVE"**ISSUE**

The heat pump has sensed the air temperature has dropped below 37° F (3° C). This is the default setpoint before the heat pump begins to circulate water to groups marked as needing freeze protection. The heat pump will not heat water in these conditions. (See "*Freeze Protection*" on page 36 for more information.)

NOTICE

Failure to heed the following may result in damage to equipment.

- Freeze protection is meant to be temporary. If freezing temperatures will continue for an extended time frame, the pool equipment ***must*** be winterized.

NOTE

The freeze protection feature's "protect on setpoint" can be manually changed from (33° to 39° F (.6° to 4° C). The default is 37° F (3° C)

PLEASE NOTE:

This protection is only available for heat pumps that directly control a circulation pump.

Displays "NO SYSTEM FIRMWARE"**ISSUE**

The heat pump has encountered a software error.

RESOLUTION

1. If heat pump is using a PoolSync[®], confirm the device is connecting to the internet. It will automatically attempt to load firmware on the heat pump. See PoolSync[®] manual for specifics.
2. Call for service.

Displays "NO POOL/SPA WATER FLOW"**ISSUE**

Low or no water detected. This is normal when the circulation pump is deactivated.

RESOLUTION

1. Confirm the filter pump is on.
2. If a multiple-speed filter pump is being used, run at a higher speed to determine if the error persists. Do not exceed the maximum flow rate for your model.
3. Confirm water is not being diverted away from the heat pump.
 - See "Water Flow Rates" on page 17.
 - See "Adjusting Water Flow Using ΔT (Delta-T)" on page 48.

Displays "NO POOL/SPA GROUP EXISTS "**ISSUE**

When pushing the POOL / SPA button, the heat pump displays the message "NO POOL/SPA GROUP EXISTS".

RESOLUTION

In order for this button to be active, a Pool Group, Spa Group, or both, must be created; either using a preset option or manually.

NOTE

*The standard (from the factory) heat pump **does not have** a group or schedule. These can be created as needed depending on if a heat pump option has been utilized. See [Product Manual Options](#) for more information on available options.*

Displays "POOLSYNC NO WIFI"

ISSUE

Internal WiFi has been activated, but the heat pump is not connected to the user's home WiFi access point.

RESOLUTION

Confirm if the heat pump's WiFi setup process been completed:

- If the WiFi has been successfully setup in the past, check that the mode on the heat pump has been set to "NORMAL".
- If the WiFi has never been successfully setup in the past, check that the heat pump mode has been set to "SETUP". Then complete the WiFi setup.
- See "*WiFi modes*" on page 28.

Confirm the heat pump is properly communicating with the user's home WiFi:

- Check that the user is using the correct password for the home's WiFi.
- Confirm user's home WiFi is in range, powered, and working with other devices in the home.
 - This can be done by checking the RSSI in application. If the RSSI is showing as "poor", the user may need to consider using a WiFi extender.

Displays "POOLSYNC NO CLOUD"

ISSUE

Internal WiFi has been activated, but the heat pump cannot access the cloud (internet access).

RESOLUTION

Confirm that the heat pump has successfully connected to the home's WiFi access point.

- Has setup been successfully completed? If not, this is a message that shows in the setup process and will go away when setup is completed. Please wait until is complete.
 - The mode will show as "NORMAL". See "*The "NORMAL" mode:*" on page 29.
- This may be a home internet issue. Confirm that the user's internet is active and that the user's WiFi access point is working.
- Possible issue with the external cloud service. Wait for one hour. If issue continues, contact installing dealer for service. For further assistance, please contact AquaCal. See "Contacting AquaCal AutoPilot, Inc."

Displays "POOLSYNC NOT DETECTED"

ISSUE

Internal WiFi has been activated, but the heat pump cannot detect the WiFi feature in the heat pump equipment.

RESOLUTION

- The heat pump may not have an internal WiFi feature. If this feature is not included with the heat pump, change the WiFi feature mode to "OFF".
- The internal WiFi equipment may not be wired correctly. Call installing dealer for service. For further assistance, please contact AquaCal. See "Contacting AquaCal AutoPilot, Inc."

Displays "POOLSYNC SERVICE ACCESS"**ISSUE**

Internal WiFi has been activated, and the heat pump is currently in WiFi service access mode.

RESOLUTION

- If not intending to use the heat pump's WiFi in service access mode, change the heat pump WiFi mode to "NORMAL" or "OFF".
- See "*WiFi modes*" on page 28.

Displays "POOLSYNC SETUP MODE"**ISSUE**

Internal WiFi has been activated, and the heat pump is currently in WiFi setup mode.

RESOLUTION

- If not intending to setup the heat pump WiFi feature, change the heat pump WiFi mode to "OFF".
- If setting up WiFi, this is a normal message that will not display after WiFi setup process is complete.
- See "*WiFi modes*" on page 28.

Displays "SET TO SWITCH REMOTELY"**ISSUE**

If when pressing the "Pool / Spa" button the display flashes the message "**SET TO SWITCH REMOTELY**", the heat pump is using a remote relay switch or a 3-wire controller.

RESOLUTION

- The Pool and Spa thermostat automatically switch when using these modes.
- Operation manually will not be available when using these external devices. No action is required.

Displays "UNIT MODEL NUMBER"**ISSUE**

The heat pump has encountered a software error.

RESOLUTION

- The model number and serial number will need to be re-entered into the system. The system will then operate as normal.
- If the issue reoccurs, please contact AquaCal® Technical Support.

Heat Pump Not Running

ISSUE

The heat pump will not run.

RESOLUTION

1. Confirm equipment is receiving power. Is the heat pump display illuminated?
 - If not, confirm the main breaker (located at the power supply panel) and the disconnect switch (located near the heat pump) are both turned on.
 - If the display still does not illuminate, it is recommended that the heat pump installer or electrician confirm the heat pump is receiving power.
2. Confirm correct mode is selected.
3. Confirm thermostat is set correctly.
 - When heating the water is desired, the thermostat should be set above the current water temperature.
 - When cooling the water is desired, the thermostat should be set below the current water temperature.
4. If an error code is displayed, diagnose and correct the cause of the code.
 - See "Fault Codes" on page 69.
5. If the heat pump is using an external controller, the heat pump may not be set correctly to accept the controller's signal.

Heat Pump's Tripping Breaker

ISSUE

The heat pump breaker(s) keeps tripping.

RESOLUTION

1. If AquaCal[®] heat pumps have been connected using a multiple heat pump configuration, the configuration may be incorrect. Please confirm settings or contact installer of equipment.
2. Have an electrician confirm breakers are correct type, in good condition, and properly sized for the heat pump.

Heat Pump Won't Shut Off

ISSUE

The heat pump will not deactivate.

RESOLUTION

PLEASE NOTE

When the heat pump is set to off, the display will show the current water temperature or no water flow indicator.

1. Confirm the correct mode has been set on the heat pump.
2. Confirm the heat pump has reached the desired temperature set on the thermostat. The heat pump will continue to run until the set temperature is reached.
3. If the heat pump is using an external controller, it may not be set correctly. See the external controller's manual.

Heat Pump Is Running, Not Heating

ISSUE

The heat pump is running. But the water is not heating.

RESOLUTION

1. If the heat pump is using an external controller, confirm it is set correctly.
 - See operation manual for operating heat pump with an external controller.
 - If the heat pump is still not running correctly with this device, contact the installer of the device or the device's manufacturer for further assistance.
2. Confirm heat pump mode is set to heat.
3. Confirm thermostat is set higher than the current water temperature.
4. Confirm valves are positioned to heat the correct body of water (either the pool or the spa). If heating a spa that overflows into a pool, confirm the spa is isolated when being heated (not flowing into the pool).
5. Confirm heat pump is transferring heat into the water.
 - Measure the temperature of air discharge coming out of the heat pump fan. If discharge air is between 8° to 16° F (-13° to -9° C) colder than the outside ambient air, the heat pump is moving heat into the water.
6. If an error code is displayed, diagnose and correct cause of code.
 - See "*Fault Codes*" on page 69.
7. Confirm that the filter pump has a sufficient run-time. The heat pump will not run (or heat the water) without water flow.
8. If heating a spa, deactivate air blower or venturi (if equipped) to allow for quicker heating times. For pools, deactivate water features, such as slides, waterfalls, or fountains to allow water to retain heat. Use of a liquid pool blanket product, such as an Aqua Blanket™, can also compensate for excessive heat loss.

Heat Pump Is Running, Not Cooling

ISSUE

The heat pump is running. But the water is not cooling.

RESOLUTION

1. If the heat pump is using an external controller, confirm the heat pump is programmed properly to allow for cooling.
2. Confirm the heat pump mode is set to cool.
3. Confirm the thermostat is set below the current water temperature.
4. Confirm valves are positioned to cool the correct body of water (either the pool or the spa). If cooling a spa that overflows into a pool, confirm the spa is isolated when being cooled (not flowing into the pool).
5. If an error code is displayed, determine and correct the condition causing the code.
 - See "*Fault Codes*" on page 69.
6. Confirm heat pump is transferring heat out of the water.
 - Measure the temperature of air discharge coming out of the heat pump's fan. If the air is between 8° to 16° F (-13° to -9° C) warmer than the outside ambient air, the heat pump is moving heat out of the water.
7. Confirm that the filter pump has a sufficient run-time. The heat pump will not run (or cool the water) without water flow.

Ice Forming on the Heat Pump

ISSUE

When conditions are too cold for proper operation, the heat pump will enter a defrost mode. This prevents ice from building up on the evaporator coil.

RESOLUTION

Heat Only Units:

- The heat pump may develop a fine layer of white frost on the outside coil before entering the defrost mode. This is normal.
 - See "*Displays Defrosting*" on page 77.
- If heavy ice (not frost) starts to build up, shut off the heat pump. Contact the installer or manufacturer.
- If the ambient air temperature will be falling below 32° F (0° C) for more than 8 hours, winterize equipment.

Cool Only Units

- The heat pump may enter defrost mode if the water flow rate falls below the acceptable range. See "*Water Flow Rates*" on page 17.
- If the ambient air temperature will be falling below 32° F (0° C) for more than 8 hours, winterize equipment.

Heat and Cool Units (with Active Defrost or “Icebreaker”):

- During freezing conditions, pool or spa heating will continue. Frost or ice may develop during the “countdown” to the active defrost (up to 50 minutes). This is normal. See "*Displays Defrosting*" on page 77.
- The heat pump will enter an "active defrost" stage to remove the accumulated frost and ice.
 - Be sure to observe the unit for at least 50 minutes. If it has not entered an active defrost cycle, call for service.

TIP:

The heat pump can be manually defrosted by temporarily switching to the cooling mode until the ice or frost melts.

- If the ambient air temperature is (or will be) falling below 32° F (0° C) for more than 8 hours, winterize equipment.

"Pool / Spa" Button Isn't Working

ISSUE

The "Pool / Spa" button is disabled if the following devices have been configured on the heat pump.

- A 2-wire external controller.
- A 3-wire external controller.
- A "SMART" external controller.
- An external flow switch.

RESOLUTION

If not used to operate the heat pump, deactivate the external control device.

Schedule Not Working

ISSUE

A device isn't operating as scheduled.

RESOLUTION

- Confirm the device is part of the scheduled group.
- Confirm the group has an appropriate schedule program. See options manuals for help on creating schedules.
- Confirm the schedule mode is set to "AUTO" and the scheduled program mode is set to "ON". See "*Schedule and Program Modes*" on page 41.
- Confirm the time is set correctly in the system. See equipment manual for information on changing date and time on heat pump.

NOTE

*The standard (from the factory) heat pump **does not have** a group or schedule. These can be created as needed depending on if a heat pump option has been utilized. See [Product Manual Options](#) for more information on available options.*

Water Coming From Heat Pump

ISSUE

The water may be normal condensation produced as a by-product of the heat pump's refrigeration process.

The heat pump can produce up to 8 to 10 gallons (30 to 38 liters) of condensation per hour depending on the humidity of the ambient air. Determine if the water is condensation or a possible leak.

RESOLUTION

1. Deactivate heat pump, leaving the filter pump on. After several hours, determine if the water is still coming from the heat pump.
2. If using chlorine or bromine as a pool/spa sanitizer, test the water around the heat pump using a test strip. If the test strip indicates that chlorine or bromine is present, a leak may exist.

PLEASE NOTE -

If desired, a kit is available to re-direct condensation water away from the heat pump.

NOTES UNLESS OTHERWISE SPECIFIED:
 1. DIMENSIONS IN [] ARE IN MILLIMETERS

REVISION TABLE			
REV.	PCA NUMBER/DESCRIPTION	CHANGED BY	DATE
A	INITIAL RELEASE	RENEEC	7/6/2023
B	RMV'D CHART & NOTE 2	RENEEC	12/20/2024
C	ADDED "HEATWAVE" TO DESCRIPTION	JOSHE	2/24/2026

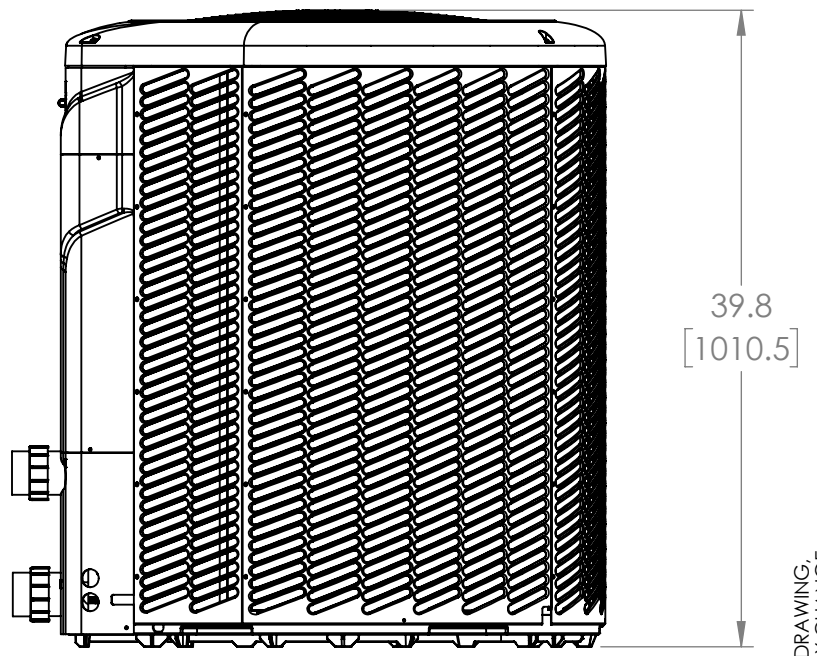
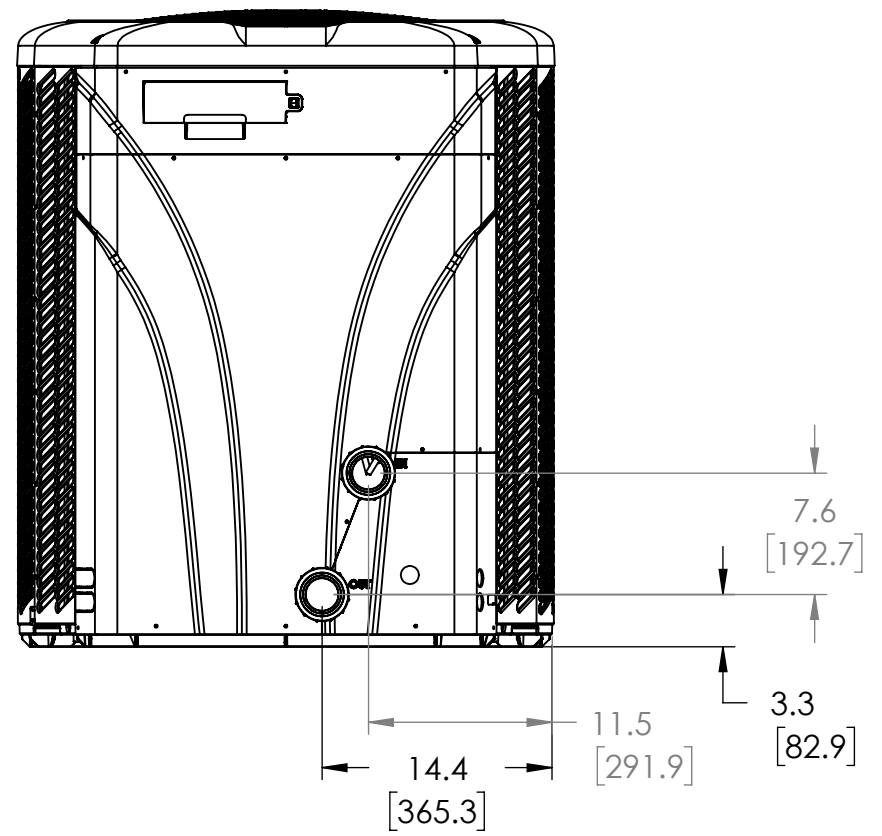
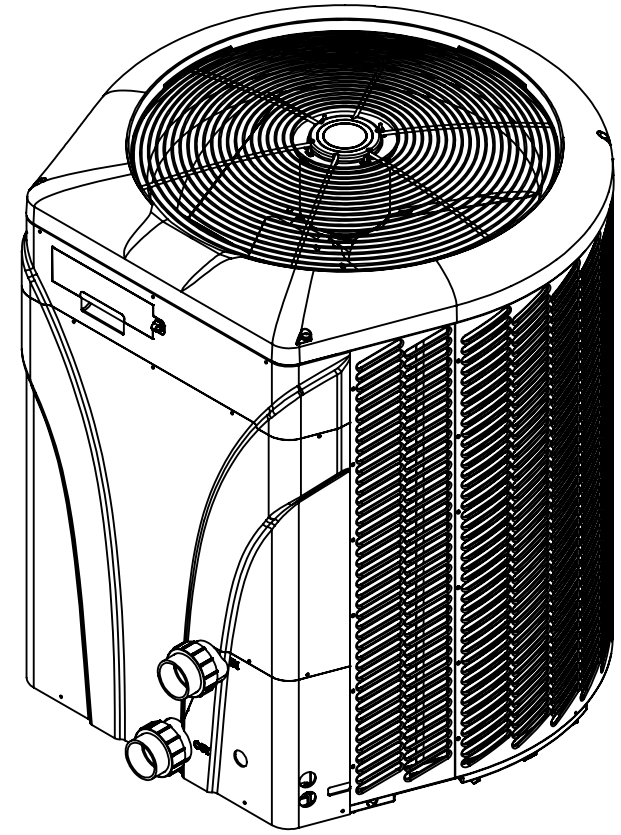
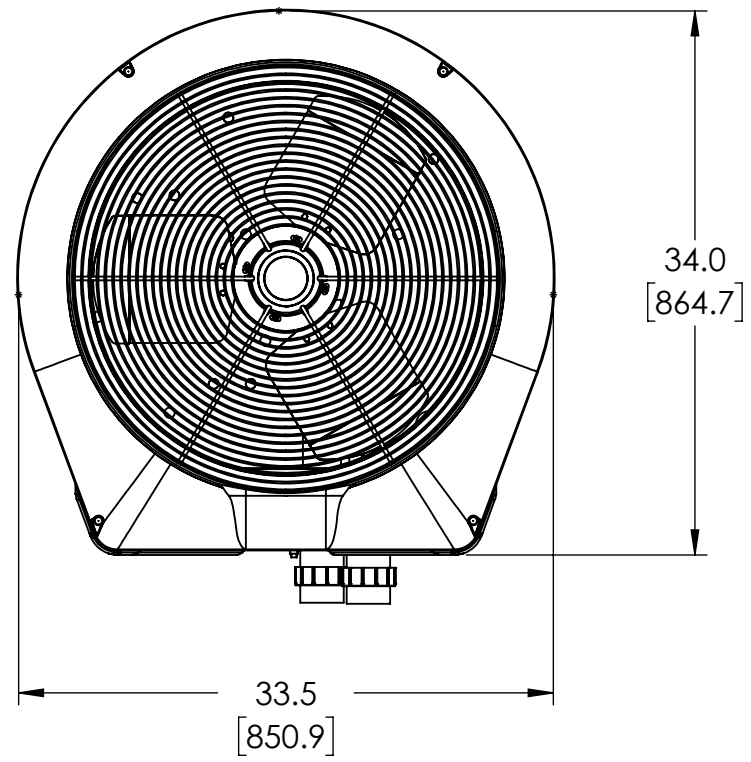



AquaCal
SALT CHLORINE GENERATORS

The Innovative Leader In
Pool & Spa Water
Conditioning Equipment
2737 24th St. No.
St. Petersburg, FL 33713



AUTOPILOT
SALT CHLORINE GENERATORS

<p>CAD GENERATED DRAWING, DO NOT MANUALLY CHANGE</p>	<p>UNLESS OTHERWISE SPECIFIED, DIMENSIONS ARE INCHES [MILLIMETERS]</p> <p>TOLERANCES: DECIMALS ANGLES</p>	<p>DESCRIPTION UNIT OVERALL DIMENSIONS HEATWAVE, SUPERQUIET, TROPICOOOL W/TRIM PIECE</p>
<p>DATE: 12/18/2024</p>		<p>DATE: 7/6/2023</p>
<p>MODELED BY: RBC</p>		<p>DRAWN BY: RBC</p>
<p>PROJECT ENG: RBC</p>		<p>CHK'D BY: RBC</p>
<p>INFORMATION CONTAINED IN THIS DRAWING IS THE SOLE PROPERTY OF AQUACAL AUTOPILOT, INC. ANY REPRODUCTION IN PART OR WHOLE WITHOUT WRITTEN PERMISSION OF AQUACAL AUTOPILOT, INC. IS PROHIBITED.</p>		<p>DWG. NO. LTM1108</p>
<p>SCALE 1:12</p>		<p>DWG SIZE B</p>
<p>DO NOT SCALE DRAWING</p>		<p>CAD FILE: LTM1108</p>
		<p>REVISION A</p>
		<p>SHEET 1 OF 1</p>

ITEM NO.	DESCRIPTION
1	PLASTIC TRIM PIECE
2	FAN GRILLE
3	FAN MOTOR
4	FAN BLADE
5	FAN TOP
6	CONTROL PANEL DISPLAY
7	TOUCHPANEL MOUNT
8	CONTROL BOX COVER
9	CONDENSER KIT FOR SERVICE
10	COMPRESSOR
11	FRONT PANEL
12	FRONT PANEL, UNIONS
13	FRONT PANEL, CONTROL MOUNT
14	TXV
15	WATER TEMPERATURE SENSOR
16	REVERSING VALVE
17	FILTER DRIER
18	EVAPORATOR
19	COREMAX
20	REF. HIGH PRESSURE SWITCH
21	SECONDARY REF. HIGH PRESS. SWITCH
22	HOSE BARB
23	DEFROST SENSORS
24	UNIONS
25	COMPRESSOR WIRE HARNESS

HEATWAVE, SUPERQUIET, TROPICOOOL
CHILLER & REVERSING HEATPUMP
POOL HEATER: REF NO. LTM17153



LAST REVISION BY: J. ENRICO
LAST UPDATE: 2/24/2026

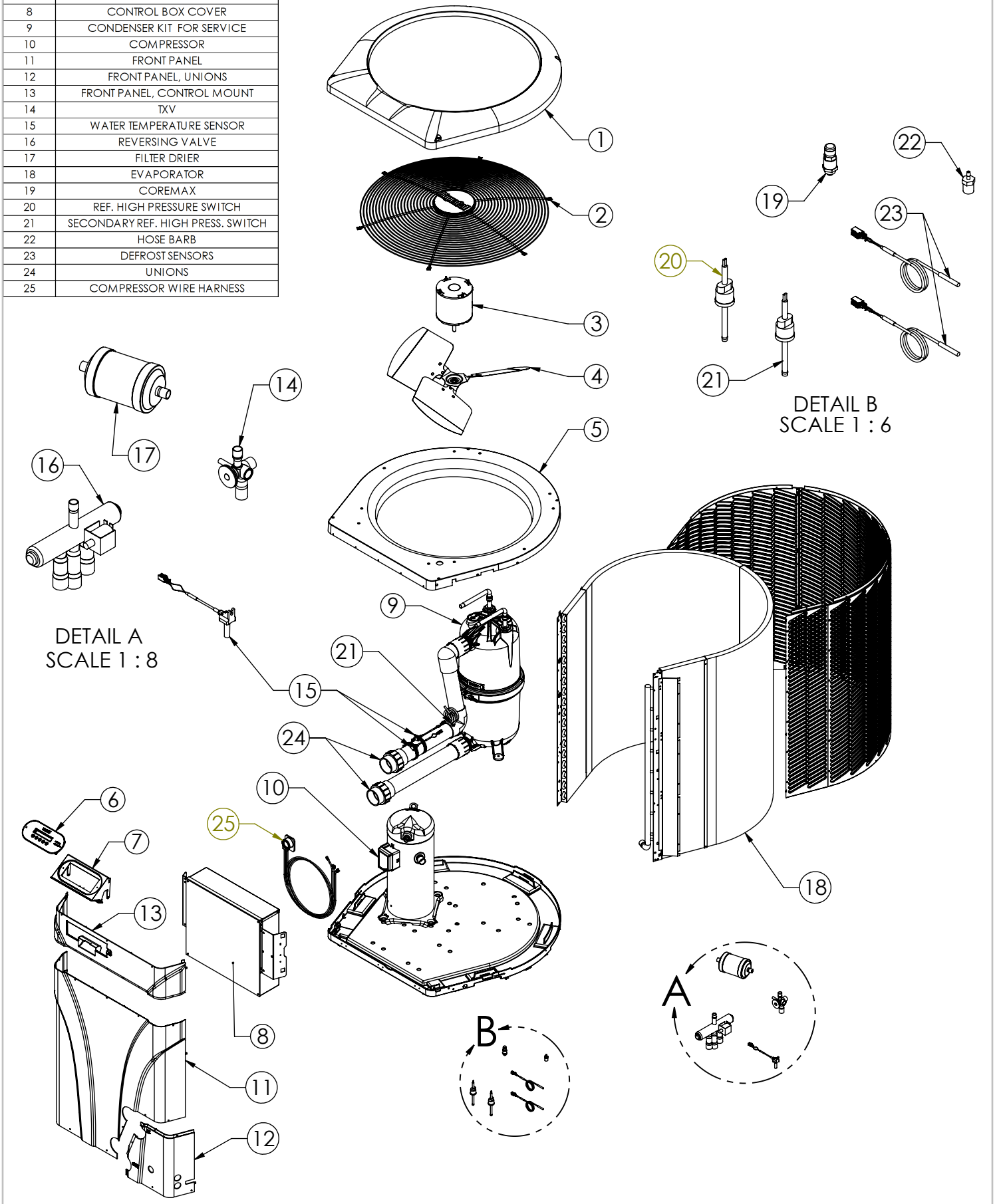

NOTES UNLESS OTHERWISE SPECIFIED:
 1. EQUIVALENT PARTS MAY VARY
 IN APPEARANCE AND LOCATION

REVISION TABLE			
REV.	PCA NUMBER/DESCRIPTION	CHANGED BY	DATE
B	Correction to item numbers	JENRICO	2/7/2025
C	Added "HW" to description	JENRICO	2/24/2026

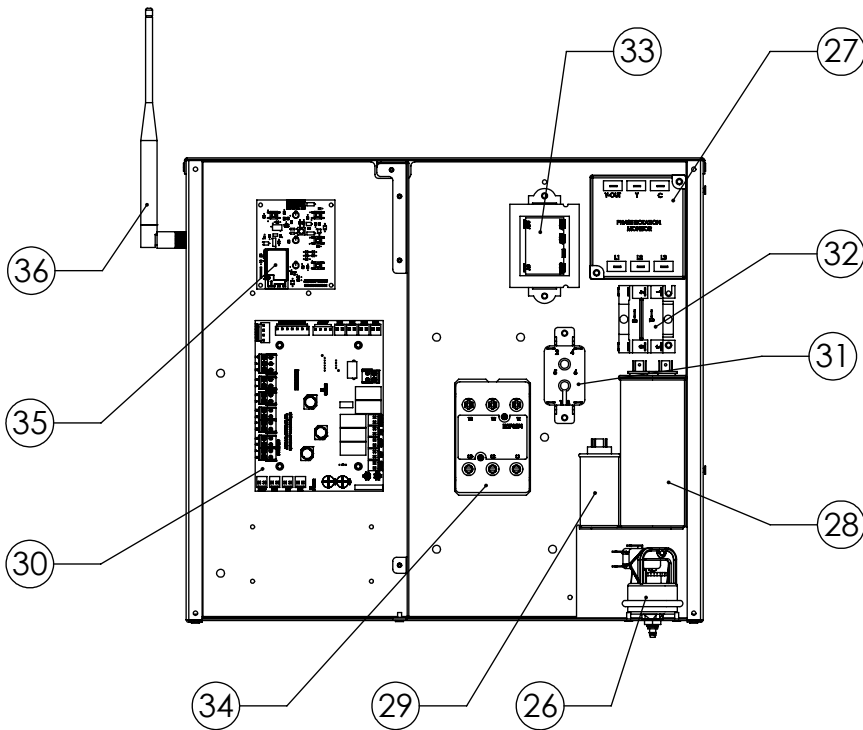

ITEM NO	GENERIC DESCRIPTION
26	WATER PRESSURE SWITCH
27	PHASE ROTATION MONITOR
28	RUN CAPACITOR
29	FAN CAPACITOR
30	CONTROL BOARD
31	FAN RELAY
32	SECONDARY FAN RELAY
33	TRANSFORMER
34	CONTACTOR
35	POOLSUNC BOARD
36	POOLSUNC ANTENNA

CAD GENERATED DRAWING.
DO NOT MANUALLY CHANGE



UNLESS OTHERWISE SPECIFIED,
DIMENSIONS ARE
INCHES [MILLIMETERS]

TOLERANCES:
DECIMALS ANGLES
TBD TBD

MATERIAL

FINISH

DO NOT SCALE DRAWING

*The Innovative Leader In
Pool & Spa Water
Conditioning Equipment*
2737 24th St. No.
St. Petersburg, FL 33713



DESCRIPTION
**ELEC COMPONENT
LAYOUT,GENERIC,HW SQ TC**

MODELED BY: JSE	DRAWN BY: JENRICO	PROJECT ENG: JLANE	CHK'D BY: JLANE
DATE: 6/23/2022	DATE: 12/23/2024		

INFORMATION CONTAINED IN THIS
DRAWING IS THE SOLE PROPERTY OF
AQUACAL AUTOPILOT, INC. ANY
REPRODUCTION IN PART OR WHOLE
WITHOUT WRITTEN PERMISSION OF
AQUACAL AUTOPILOT, INC. IS PROHIBITED.

DWG. NO. **LTM17162**

SCALE 1:6	DWG SIZE A	REVISION H
---------------------	----------------------	----------------------

CAD FILE: LTM17162

SHEET 1 OF 1
Last Revision:
02/07/24

<i>A = 208/230V Single Phase</i>		<i>B = 208/230V 3 Phase</i>		<i>G = 460V 3 Phase</i>		
	Model	SQ140		SQ200		
	Model Revision	A		A		
	Voltage	A	B	A	B	G
Item	Description	Reference Part				
1	Trim	STP15908		STP15908		
2	Fan Grille	GRS0038		GRS0038		
3	Fan Motor	ECS0095		ECS0095	ECS0263	
4	Fan Blade	STK0198		STK0198		
5	Fan Deck	PCS0342		PCS0342		
6	Control Display	ECS0503		ECS0503		
7	Control Mount	PCS0347		PCS0347		
9	Condenser	STK0235		STK0234		
10	Compressor	COS0059	COS0066	COS0063	COS0065	COS0061
11	Front Panel	PCS0344		PCS0344		
12	Union Panel	PCS0356		PCS0356		
13	Upper Control Mount	PCS0355		PCS0355		
14	TXV	RES0053		RES0053		
15	Water Temp Sensor	ECS0393		ECS0393		
16	Reversing Valve	RES0002		RES0002		
17	Filter Drier	RES0072		RES0072		
18	Evaporator	ACP0034		ACP0039		
19	Coremax	RES1055/RES1058		RES1055/RES1058		
20	High Pressure Switch	STP0018		STP0018		
21	Secondary High Pressure Switch	STP0017		STP0017		
22	Hose Barb	PLS2642		PLS2642		
23	Defrost Sensor DS1 Defrost Sensor DS2	STP17315		STP17315		
		STP17316		STP17316		
24	Unions	PLS2627		PLS2627		
25	Compressor Harness	STP17295		STP17295		
26	Water Pressure Switch	STK15513		STK15513		
27	Phase Rotation Monitor	N/A	STK0058	N/A	STK0058	
28	Run Capacitor	ECS0247	N/A	ECS0247	N/A	

29	Fan Capacitor	ECS6052	ECS6052	ECS6051
30	Control Board	ECS0501	ECS0501	
31	Fan Relay	STP17169	STP17169	
32	Secondary Fan Relay	STK0259	STK0259	
33	Transformer	ECS6209	ECS6209	STP17170
34	Contactora	ECS16047	STP17168	ECS16047 STP17168
35	PoolSync Board	STK16906	STK16906	
36	PoolSync Antenna	STP16905	STP16905	

NOTES UNLESS OTHERWISE SPECIFIED:
 1. USE COPPER CONDUCTORS ONLY
 2. TO BE WIRED IN ACCORDANCE WITH
 NAT'L ELEC (NEC) & LOCAL CODES
 3. CONNECT TO TRANSFORMER TO CORRECT VOLTAGE
 4. LINE VOLTAGE CODES

A: 208-230VAC/60Hz/1Φ

H: 200-240VAC/50Hz/1Φ

REVISION TABLE			
REV.	PCA NUMBER/DESCRIPTION	CHANGED BY	DATE
B	ADDED POOLSYNC	JOSHE	12/13/2024
C	Corrected Poolsync wire colors/order	JOSHE	2/17/2025

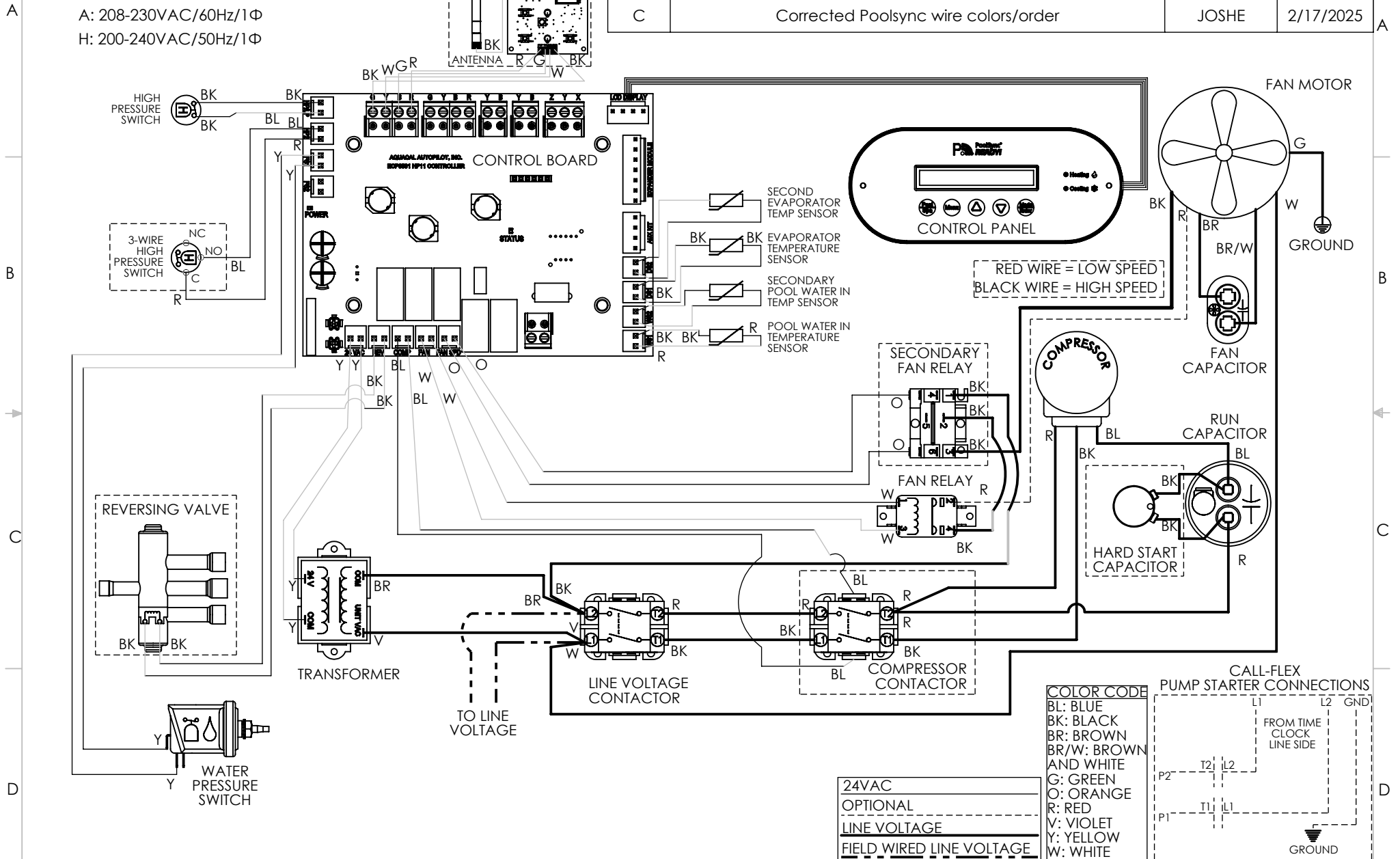

MODELED BY: JSE | DATE: 9/10/2023 | DRAWN BY: JSE | DATE: 11/20/2023

CAD GENERATED DRAWING. DO NOT MANUALLY CHANGE. DO NOT SCALE DRAWING.
 INFORMATION CONTAINED IN THIS DRAWING IS THE SOLE PROPERTY OF THE MANUFACTURER.
 ANY REPRODUCTION IN PART OR WHOLE WITHOUT WRITTEN PERMISSION OF THE MANUFACTURER IS PROHIBITED.

DWG SIZE DESCRIPTION: **A** DIAGRAM, WIRING, 1PH, 2-SPD, 4-WIRE, HP 11

SHEET 1 OF 1 | DWG. NO. LTM1127 | REVISION F

CAD FILE LTM112 | Last Revision: 02/07/24

