

RH Recessed Wall/Step Light DESIGNER PLUS



PROJECT
CATALOG #
TYPE
NOTES

Designed for sleek, seamless installation, the fully recessed RH Step Light is a modern upgrade to lighting walkways and stairs. The fixtures are available with 1LED, 3LED, and ZDC configurations. The recessed integrated LED light sources are diffused for soft illumination on steps and walkways and maximum glare control, critical for applications where grade changes are inevitable and safety is a top priority. Fully potted with robust mechanical sealing and compatible with standardized single-gang junction boxes, the RH fixture is ideal for near-grade installations.

Quick Facts

- Die-cast aluminum
- Lumileds® integrated LEDs
- Two-layer marine-grade anodization and powder coat finish
- Compatible with Luxor® technology
- Compatible with standardized single-gang junction boxes
- Phase dimmable
- Input voltage: 10-15 V

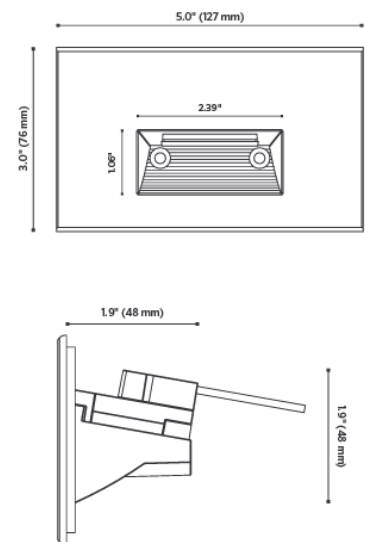

RH Recessed Wall/Step Light SPECIFICATIONS

Output	1LED	3LED	ZDC
Total Lumens[†]	36	86	98
Input Voltage	10 to 15V	10 to 15V	11 to 15V
Input Power	1.9 W	4.0 W	6.0 W
Power Consumption (VA)	2.2 W	4.4 W	7.2 W
Efficacy (Lumens/Watt)	19	23	17
Color Rendering Index (CRI)	84	84	80+
Max Candela	21	49	56
RGBW Available	No	No	Yes
Luxor Compatibility			
Default	Zoning	Zoning	--
ZD Option	Zoning/Dimming	Zoning/Dimming	--
ZDC Option	--	--	Zoning/Dimming/Color
Minimum Rated Life L70 (Hrs)	72,000	72,000	55,000

** For optimal performance, use a trailing-edge, phase-cut dimmer.

† Measured using the 2,700K CCT option.

RH Recessed Wall/Step Light SPECIFICATIONS

About FX Luminaire

As a leading manufacturer of landscape and architectural lighting, FX Luminaire provides innovative products, resources, and support to help customers bring their visions to life. The company offers a range of specification-driven solutions, including fixtures, controls, and accessories, to enhance residential and commercial landscapes.

Materials

Die-cast A380 aluminum body with stainless steel setscrews, mounting brackets, and fasteners.

LED

Integrated module with Cree LEDs. Gold-plated connectors and conformal coated for maximum reliability and corrosion resistance. Proprietary on-board intelligent driver uses firmware-controlled temperature regulation, maximizing LED life. Field upgradeable and replaceable, the LEDs are rated to 50,000 hrs. Maximum drive current: 1 A.

Finish

Two-layer protection of sulfuric acid anodization and polyester TGIC powder-coat layer, providing superior outdoor weathering in all conditions. Tested to ASTM Standards.

Hardware

Tamper-resistant stainless steel fasteners included.

Wiring

18 AWG (1 mm); SPT-1W; 200°F (105°C); 300V; 10' (3 m) length.

Sockets

Socket contains MoistureBlock™ technology, preventing moisture from wicking up into sealed areas of the fixture.

Optics

Color temperature defined by part number. Beam angle is calculated using LM-79 method for SSL luminaires.

Power

Input 10–15 VAC/VDC, 50/60 Hz. Remote transformer required (specify separately).

Housing

Die-cast A380 aluminum body with capacity for 1 LED, 3 LED, or ZDC integrated LEDs.

Weight

1.0 lbs. (0.5 kg)

Lens

Polycarbonate lens with shock resistance and high tolerance for thermal expansion and stress.

Ambient Operating Temperature

0°F to 140°F (-18°C to 60°C)

Sustainability

Innovation meets conservation in the design and manufacturing of our products. Where we can, we use recycled materials while maintaining superior functionality. Our LED products provide high quality light at optimal energy efficiency, lifespan, and durability.

Installation Requirements

Designed for recessed installation in a vertical wall in the down lighting position only.

Control

ZD or ZDC utilizes Luxor technology to zone fixtures in up to 250 groups, dim each group in 1% increments between 0 and 100%, or change to one of 30,000 colors with RGWB LEDs. Select the ZD option for zoning/dimming or ZDC for zoning/dimming/color. Standard fixture is zoneable with Luxor Controller.

Manufacturing

ISO 9001:2015 certified facility





Warranty

10-year limited warranty.

Listings



RH Recessed Wall/Step Light ORDERING INFORMATION

Fixture	Power	Color Temp	Faceplate	Finish
RH	1 LED 1.9W/2.2VA	W Warm (2700K)	RB	BZ Bronze Metallic 
	3 LED 4.5 VA	S Soft (3000K)		FB Black 
	ZD3LED Zone/Dim; 4.0 W/4.4 VA	[Default] RGBW, ZDC Option Required		DG Desert Granite 
	ZDC Zone/Dim/Color; 6.0 W/7.2 VA			WI Weathered Iron 
				SB Sedona Brown 
				FW Flat White 
				SV Silver 



EXAMPLE FIXTURE CONFIGURATION: *RH*-XX-XXXX-XX

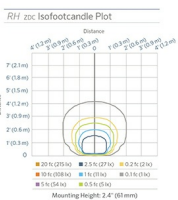
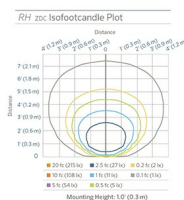
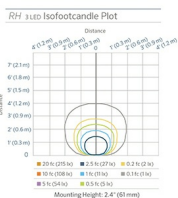
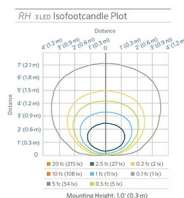
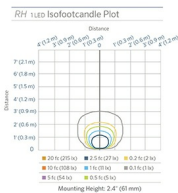
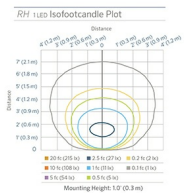

RH Step Light Recommended Spacing				
Foot-Candles (Lux)	1 LED		3 LED	
	2.4" (60 mm) MH	1.0 ft (0.3 m) MH	2.4" (60 mm) MH	1.0 ft (0.3 m) MH
0.1 fc (1.1 lx)	3.6 ft (1.1 m)	6.4 ft (2.0 m)	4.6 ft (1.4 m)	8.2 ft (2.5 m)
0.3 fc (3.2 lx)	2.4 ft (0.7 m)	4.6 ft (1.4 m)	3.2 ft (1.0 m)	6.0 ft (1.8 m)
0.5 fc (5.4 lx)	2.2 ft (0.7 m)	4.0 ft (1.2 m)	2.5 ft (0.8 m)	5.0 ft (1.5 m)
1.0 fc (10.7 lx)	1.6 ft (0.5 m)	3.0 ft (0.9 m)	2.2 ft (0.7 m)	4.0 ft (1.2 m)
2.5 fc (23.1 lx)	1.4 ft (0.4 m)	2.0 ft (0.6 m)	1.6 ft (0.5 m)	2.8 ft (0.9 m)

0.1 fc (1.1 lx) minimum spacing recommended for residential projects
 0.3 fc (3.2 lx) minimum spacing recommended for commercial projects

RH Recessed Wall/Step Light ORDERING INFORMATION

POWER OPTIONS: Specify Separately

Power	Catalog No.	Power	Catalog No.
Single-Gang Junction Box	JB-1G-NW-NM		

