



HAYWARD[®]

POOL AND SPA/HOT TUB HEATERS H135ID & ABG135 MODELS

SERVICE & INSTALLATION MANUAL

**Unit must be installed outdoors only and below an
altitude of 2000 feet**

FOR YOUR SAFETY

⚠ WARNING: If the information in these instructions is not followed exactly, a fire or explosion may result causing property damage, injury, or death.

- Do not store or use gasoline or other flammable vapors or liquids in the vicinity of this or any other appliance.

WHAT TO DO IF YOU SMELL GAS:

- Do not try to light any appliance.
- Do not touch any electrical switch; do not use any phone in your building.
- Immediately call your gas supplier from a neighbor's phone. Follow the gas supplier's instructions.
- If you cannot reach your gas supplier, call the fire department.
- Installation and service must be performed by a qualified installer, service agency, or the gas supplier.

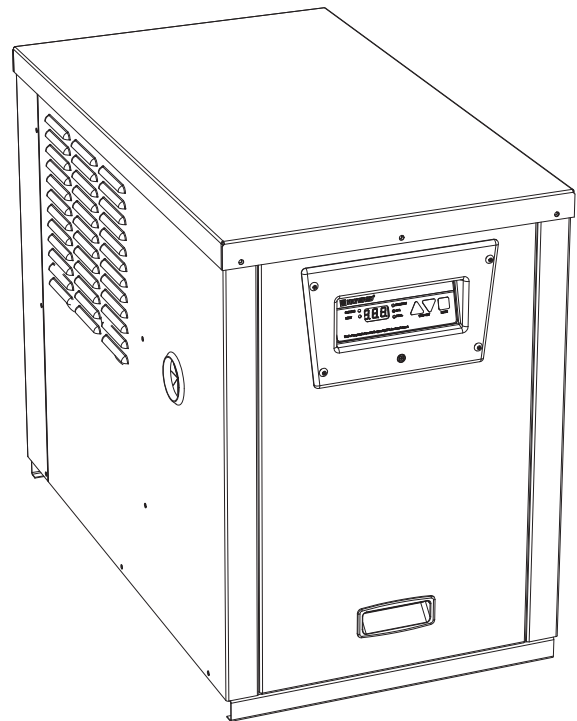





FOR YOUR SAFETY

This product must be installed and serviced by authorized personnel, qualified in pool/spa heater installation. Improper installation and/or operation can create carbon monoxide gas and flue gases that can cause serious injury, property damage, or death.

Safety Information	3	Igniter	31
Section I General information	7	Flame sensor	32
Introduction	7	Burner orifices	32
Warranty Summary	7	Gas conversion	32
Maintaining proper water chemistry	7	Electrical wiring	32
Section II Installation	9	Ignition control system	32
Equipment inspection	9	Blower vacuum switch	33
Important notice	9	High limit switches	33
Conformance with codes	9	Exhaust gas temp limit	34
Locating the heater	9	Thermistor	34
Flooring	10	Water pressure switch	34
Clearances	10	Transformer	35
Gas supply and piping	12	Blower	35
Water piping	14	By-pass service cartridge	35
Installation above pool surface	15	Section V Troubleshooting	36
Chlorinator/chemical feeder	16	General	36
Pressure relief valve	16	Automatic reset time	36
Electrical specifications	16	Supply wiring	36
Electrical connections	17	Internal wiring	36
Remote control connection	17	Fuse specifications	36
Section III Check-out & Start-up	20	Error codes	37
General	20	Troubleshooting	39
Gas line testing	21	Warranty	43
Gas pressure testing	21	Service Parts	45
Water pressure switch	22		
Two-speed pump	23		
Temperature adjustment	24		
Temperature lock-out	25		
Fahrenheit v. Celsius	25		
Heating mode	25		
Retry (Failure of light)	26		
Recycle (Loss of flame)	26		
Keypad inputs	26		
Automatic reset time	27		
Periodic inspection	27		
Winterization	27		
Draining the heat exchanger	28		
Spring start-up	28		
Section IV Technician Service	29		
General	29		
Maintenance	29		
Heat exchanger inspection and cleaning	29		
Combustion chamber	30		
Burner inspection and cleaning	30		
Burner removal and replacement	30		
Gas valve replacement	31		



USE ONLY HAYWARD GENUINE REPLACEMENT PARTS

Basic safety precautions should always be followed, including the following: Failure to follow instructions can cause severe injury and/or death.

-  This is the safety-alert symbol. When you see this symbol on your equipment or in this manual, look for one of the following signal words and be alert to the potential for personal injury.
-  **WARNING** warns about hazards that could cause serious personal injury, death or major property damage and if ignored presents a potential hazard.
-  **CAUTION** warns about hazards that will or can cause minor or moderate personal injury and/or property damage and if ignored presents a potential hazard. It can also make consumers aware of actions that are unpredictable and unsafe.
-  **ATTENTION** indicates special instructions that are important but not related to hazards.

**READ AND FOLLOW ALL INSTRUCTIONS IN THIS OWNER'S
MANUAL AND ON EQUIPMENT.
IMPORTANT SAFETY INSTRUCTIONS**



**Before installing or servicing this electrical equipment, turn power supply OFF.
KEEP SAFETY LABELS IN GOOD CONDITION AND REPLACE IF MISSING OR DAMAGED.**

-  **WARNING** – To reduce risk of injury, do not permit children to use or climb on the heater, pumps or filters. Closely supervise children at all times. Components such as the filtration system, pumps, and heaters must be positioned to prevent children from using them as a means of access to the pool.
-  **CAUTION** – This heater is intended for use on permanently installed swimming pools and may also be used with spas. Do NOT use with storable pools. A permanently installed pool is constructed in or on the ground or in a building such that it cannot be readily disassembled for storage. A storable pool is constructed so that it is capable of being readily disassembled for storage and reassembled to its original integrity.

Though this product is designed for outdoor use, it is strongly recommended to protect the electrical components from the weather. Select a well drained area, one that will not flood when it rains. It requires free circulation of air for cooling. Do not install in a damp or non-ventilated location.



-  **WARNING** – It is required that licensed electricians do all electrical wiring. Risk of Electric Shock. Hazardous voltage can shock, burn, cause death or serious property damage. To reduce the risk of electric shock, do NOT use an extension cord to connect unit to electric supply. Provide a properly located outlet. All electrical wiring MUST be in conformance with applicable local and national codes and regulations. Before working on this unit, turn off power supply to the heater.

-  **WARNING** – To reduce the risk of electric shock replace damaged wiring immediately. Locate conduit to prevent abuse from lawn mowers, hedge trimmers and other equipment.
-  **WARNING** – Failure to bond to pool structure will increase risk for electrocution and could result in injury or death. To reduce the risk of electric shock, the electrician must comply with installation instructions and must bond the heater accordingly. In addition, the licensed electrician must also conform to local electrical codes for bonding requirements.

USE ONLY HAYWARD GENUINE REPLACEMENT PARTS

NOTES TO THE ELECTRICIAN:

Use a solid copper conductor, size 8 or larger. Run a continuous wire from external bonding lug to reinforcing rod or mesh. Connect a No. 8 AWG solid copper bonding wire to the grounding lug provided on the heater and to all metal parts of swimming pool or spa, and to all electrical equipment, metal piping (except gas piping), and conduit within 5 ft. (1.5 m) of inside walls of swimming pool or spa.

IMPORTANT -Reference NEC codes for all wiring standards including, but not limited to, grounding, bonding and other general wiring procedures.



! WARNING – Suction Entrapment Hazard.

Suction in suction outlets and/or suction outlet covers which are damaged, broken, cracked, missing, or unsecured can cause severe injury and/or death due to the following entrapment hazards:

Hair Entrapment- Hair can become entangled in suction outlets.

Limb Entrapment- A limb inserted into an opening of a suction outlet or suction outlet cover that is damaged, broken, cracked, missing, or not securely attached can result in a mechanical bind or swelling of the limb.

Body Suction Entrapment- A differential pressure applied to a large portion of the body or limbs can result in an entrapment.

Evisceration/ Disembowelment - A vacuum applied directly to the intestines through an unprotected suction outlet sump or suction outlet cover which is damaged, broken, cracked, missing, or unsecured can result in evisceration (disembowelment).

Mechanical Entrapment- There is potential for jewelry, swimsuit, hair decorations, finger, toe or knuckle to be caught in an opening of a suction outlet or suction outlet cover resulting in mechanical entrapment.

! WARNING - To reduce the risk of entrapment hazards:

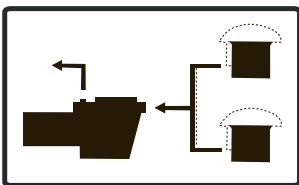

- When suction outlets are less than a 18" x 23" equivalent, a minimum of two functioning suction outlets per pump must be installed. Suction outlets in the same plane (i.e. floor or wall), must be installed a minimum of three feet (3') [1 meter] apart, as measured from near point to near point.
- Dual suction outlets shall be placed in such locations and distances to avoid "dual blockage" by a user.
- Dual suction fittings shall not be located on seating areas or on the backrest for such seating areas.
- The maximum system flow rate shall not exceed the flow rating of any listed (per current revision of ASME/ANSI A112.19.8) suction outlet cover installed.
- Never use the Pool or Spa if any suction outlet component is damaged, broken, cracked, missing, or not securely attached.
- Replace damaged, broken, cracked, missing, or not securely attached suction outlet components immediately.
- Install two or more suction outlets per pump in accordance with latest APSP (formally NSPI) Standards and CPSC guidelines. Follow all applicable National, State, and Local codes.

USE ONLY HAYWARD GENUINE REPLACEMENT PARTS

- ⚠ WARNING** – Failure to remove pressure test plugs and/or plugs used in winterization of the pool/spa from the suction outlets can result in an increase potential for suction entrapment as described above.
- ⚠ WARNING** – Failure to keep suction outlet components clear of debris, such as leaves, dirt, hair, paper and other material can result in an increase potential for suction entrapment as described above.
- ⚠ WARNING** – Suction outlet components have a finite life, the cover/grate should be inspected frequently and replaced at least every ten years or if found to be damaged, broken, cracked, missing, or not securely attached.
- ⚠ WARNING** – All suction and discharge valves **MUST** be OPEN when starting the circulation system. Failure to do so could result in severe personal injury and/or property damage. All drains and suction outlets **MUST** have properly installed covers, securely attached using the screws supplied with the covers. If screws are lost, order replacement parts from your supplier.



- ⚠ WARNING – Hazardous Pressure.** Pool and spa water circulation systems operate under hazardous pressure during start up, normal operation, and after pump shut off. Stand clear of circulation system equipment during start up. Failure to follow safety and operation instructions could result in violent separation of the pump housing and cover due to pressure in the system, which could cause property damage, severe personal injury, or death. Before servicing pool and spa water circulation system, all system and pump controls must be in off position and filter manual air relief valve must be in open position. Before starting system pump, all system valves must be set in a position to allow system water to return back to the pool. Do not change filter control valve position while system pump is running. Before starting system pump, fully open filter manual air relief valve. Do not close filter manual air relief valve until a steady stream of water (not air or air and water) is discharged.



- ⚠ WARNING – Separation Hazard.** Failure to follow safety and operation instructions could result in violent separation of pump components. Strainer cover must be properly secured to pump housing with strainer cover lock ring. Before servicing pool and spa circulation system, manual air relief valve must be in open position. Do not operate pool and spa circulation system if a system component is not assembled properly, damaged, or missing. Do not operate pool and spa circulation system unless filter air relief valve body is in locked position in filter upper body.

- ⚠ WARNING** – Never operate or test the circulation system at more than 40 PSI.

- ⚠ WARNING** – Fire and burn hazard. Motors operate at high temperatures and if they are not properly isolated from any flammable structures or foreign debris they can cause fires, which may cause severe personal injury or death. It is also necessary to allow the motor to cool for at least 20 minutes prior to maintenance to minimize the risk of burns.
- ⚠ WARNING** – Failure to install according to defined instructions may result in severe personal injury or death.

USE ONLY HAYWARD GENUINE REPLACEMENT PARTS

⚠ WARNING – The following “Safety Rules for Hot Tubs” recommended by the U.S. Consumer Product Safety Commission should be observed when using the spa.

1. Spa or hot tub water temperatures should never exceed 104°F [40°C]. A temperature of 100°F [38°C] is considered safe for a healthy adult. Special caution is suggested for young children. Prolonged immersion in hot water can induce hyperthermia.
2. Drinking of alcoholic beverages before or during spa or hot tub use can cause drowsiness, which could lead to unconsciousness and subsequently result in drowning.
3. Pregnant women beware! Soaking in water above 100°F [38°C] can cause fetal damage during the first three months of pregnancy (resulting in the birth of a brain-damaged or deformed child). Pregnant women should adhere to the 100°F [38°C] maximum rule.
4. Before entering the spa or hot tub, users should check the water temperature with an accurate thermometer; spa or hot tub thermostats may err in regulating water temperatures by as much as 4°F (2.2°C).
5. Persons taking medications, which induce drowsiness, such as tranquilizers, antihistamines or anticoagulants, should not use spas or hot tubs.
6. If the pool/spa is used for therapy, it should be done with the advice of a physician. Always stir pool/spa water before entering the pool/spa to mix in any hot surface layer of water that might exceed healthful temperature limits and cause injury. Do not tamper with controls, because scalding can result if safety controls are not in proper working order.
7. Persons with a medical history of heart disease, circulatory problems, diabetes or blood pressure problems should obtain a physicians advice before using spas or hot tubs.
8. Hyperthermia occurs when the internal temperature of the body reaches a level several degrees above normal body temperature of 98.6°F [37°C]. The symptoms of Hyperthermia include: drowsiness, lethargy, dizziness, fainting, and an increase in the internal temperature of the body.

The effects of Hyperthermia include:

1. Unawareness of impending danger.
2. Failure to perceive heat.
3. Failure to recognize the need to leave the spa.
4. Physical inability to exit the spa.
5. Fetal damage in pregnant women.
6. Unconsciousness resulting in danger of drowning.

DEFINITIONS:

Suction Outlet – The term Suction Outlet is a fitting, fitting assembly, cover/grate and related components that provide a means for water to exit the pool and into the pump circulating system.

Inches of Mercury (in Hg) - A unit for measuring pressure below atmospheric (“suction” or “vacuum”) (1.0 inch Hg = .491 PSI)

Main Drain – See Suction Outlet

PSI – An abbreviation for pounds per square inch.

USE ONLY HAYWARD GENUINE REPLACEMENT PARTS

INTRODUCTION:

This manual contains instructions for installation, operation, maintenance, troubleshooting, and parts lists for the safe use of the swimming pool/spa/hot tub heaters. Hayward strongly recommends that the installer read the manual before installing the swimming pool/spa/hot tub heater. If after reviewing the manual any questions remain unanswered, contact the factory or local representative. Following heater installation, the installer should leave all manuals with the consumer for future reference.

LIMITED WARRANTY SUMMARY:

Hayward warrants the pool/spa/hot tub heater to be free from defects in materials and workmanship, and will within one year from date of installation for all users, for the original purchaser, repair or, at our option, replace without charge any defective part. Hayward further warrant that if the heat exchanger or exchanger headers (water-containing section) leak within one year from date of such installation for all users, due to defects in materials and workmanship, Hayward will provide a replacement part. Cost of freight, installation, fuel, and service labor (after one year) is at user's expense. For full details of warranty agreement, see warranty certificate included in this manual.



ATTENTION: If the pool/spa/hot tub heater is damaged or destroyed by improper maintenance, excessive water hardness, incorrect water chemistry, or freezing it is not covered under the manufacturer's warranty.

MAINTAINING PROPER WATER CHEMISTRY:

WARNING: Failure to maintain proper water chemistry may cause premature heat exchanger damage or failure.

The heat exchanger in your Hayward pool heater is made from the highest quality of copper and nickel (Cupronickel) materials. The premium materials and the exacting processes used in the manufacture of the heat exchanger is state of the art in pool heater design and manufacture. Yet, it remains vital that the heat exchanger be protected from damaging or corrosive chemicals, insufficient water flow or improperly balanced water chemistry. Heat exchanger damage or failure resulting from improper flow, improperly balanced pool water or the improper addition of sanitizer into the water is NOT covered under the terms of your warranty.

The following factors are critical to heat exchanger protection. Follow these guidelines to help prevent pre-mature damage or failure to your heater and heat exchanger.

1. WATER FLOW THROUGH HEATER

Water must be flowing through the heater at the minimum rated flow rate during operation. Check that the pump is operating and the system is filled with water and purged of all air prior to starting the heater. The minimum rated flow rate is listed on page 15. Some installations may require an adjustment to the water pressure switch for proper low-flow protection. Test your system and if necessary, adjust the water pressure switch as described on page 22.

USE ONLY HAYWARD GENUINE REPLACEMENT PARTS

2. POOL/SPA WATER CHEMISTRY

The chemistry balance and mineral content of swimming pool water changes daily due to the addition of pool and sanitizing chemicals, bather loads, rain, runoff and the amount of sun - to name a few. Improper chemistry balance and mineral content can cause scaling and deposits to form on pool walls, in the filtration system, in the heat exchanger tubes and additionally can promote corrosive action to all metals in the water path. Changing spa water regularly and maintaining the correct chemical balance in your pool/spa will keep the pool/spa safe and sanitary, and will help protect the heat exchanger. Use a 4-way pool/spa water test kit to check your water frequently (at least weekly). Use the following guidelines to help protect your heater's heat exchanger:

	Recommended Level	Effect of Low Levels	Effect of High Levels
Chlorine	1 - 3 ppm	hazy water, alga growth, bacteria causing infections	swimmer irritation, bleaching of clothes/hair, corrosive to heat exchanger
Bromine	2 - 4 ppm		
pH	7.4 - 7.6	corrosive to heat exchanger, swimmer irritation	cloudy water, scaling of heat exchanger, reduced sanitizer effectiveness
Total Alkalinity	80 - 120 ppm	corrosive to heat exchanger, large fluctuations in pH	scaling of heat exchanger
Calcium Hardness	200 - 400 ppm	corrosive to heat exchanger	scaling of heat exchanger
Salt	2700 - 5000 ppm	poor salt chlorinator performance	corrosive to heat exchanger

3. SKIMMER CHLORINATION

Placing chlorine or bromine tablets directly into the skimmer may result in high chemical concentrations flowing through the heater. DO NOT place chlorine or bromine tablets in the skimmer.

4. CHLORINATOR INSTALLATION

Chlorinators must be installed downstream of the heater, and a check valve must be installed between the heater and chlorinator to prevent high chemical concentrations from back flowing into the heater. Make sure your piping arrangement meets the chlorinator installation requirements shown on page 16.

5. BYPASS

Until water chemistry is properly balanced, and if your piping has a bypass valve installed for the heater, open the bypass so that corrosive and potentially damaging water will not flow through the heater and therefore the heat exchanger. Close the bypass valve once the water is properly balanced. Failure to close the bypass valve when attempting to operate the heater will result in extensive damage to the heat exchanger. Ensure water flow through the heater is restored before operating the heater. A bypass feature is also advantageous for service needs and for the ability to remove the heater from the water path when not heating. Refer to page 15 for further information.

USE ONLY HAYWARD GENUINE REPLACEMENT PARTS

EQUIPMENT INSPECTION:

On receipt of the heater, inspect the heater carton(s) for damage. If any carton(s) is damaged, note it when signing for it. Remove the heater from the carton(s) inspect it and advise the carrier of any damages at once.

IMPORTANT NOTICE:

The installation instructions are intended for the use of a qualified technician, specifically trained and experienced in the installation of this type of heating equipment. Some states or provinces require that installation be licensed. If this is the case in the state or province where heater is located, the contractor must be properly licensed.

⚠ WARNING: Failure to comply with the appliance and vent package installation instructions and service instructions in this manual may result in equipment damage, fire, asphyxiation, or carbon monoxide poisoning. Exposure to products of incomplete combustion (carbon monoxide) can cause cancer and birth defects or other reproductive harm.

CONFORMANCE WITH CODES:

The heater shall be installed in accordance with all local and state codes. The heater installation must conform to the latest edition of the National Fuel Gas Code (ANSI Z223.1/NFPA 54) and with the requirements of the authority having jurisdiction. Design certification of the heater is in compliance with ANSI Z21.56/CSA 4.7.

For Canadian installations, the heater is to be installed in accordance with the standards CAN/CGA B149.1 and B149.2 – Installation Codes for Gas Burning Appliances and Equipment and/or local codes and, if applicable, CSA C22.1 – Canadian Electrical Code, Part I.

LOCATING THE HEATER:

Locate the pool/spa/hot tub heater in an area where leakage of the heat exchanger or connections will not result in damage to the area adjacent to the heater or to the structure. When such locations cannot be avoided, it is recommended that a suitable drain pan, with drain outlet, be installed under the heater. The pan must not restrict airflow.

This heater must be installed at least (5) feet from the inside wall of a pool (in-ground or above-ground)/spa/hot tub unless separated from the pool/spa/hot tub by a solid barrier.

The heater must be installed such that the location of the exhaust gas vent outlet relative to adjacent public walkways, adjacent buildings, openable windows, and building openings complies with the National Fuel Gas Code (ANSI Z223.1/NFPA 54) and/or CAN/CGA B149 installation codes. Outdoor installation and service clearances:

The heater must be installed outdoors such that the installation and service clearances from combustible materials shown in Table 2 are maintained. This heater may be installed on combustible floors.

1. The heater is self-venting when installed outdoors and does not require additional vent piping.
2. Do not install in a location where growing shrubs may in time obstruct a heater's combustion air and venting areas.
3. Do not install this appliance under an overhang less than (3) feet from the top of the appliance. The area under the overhang must be open on (3) sides.
4. Do not install the heater where water spray from ground sprinkler can contact the heater. The water could splash on the controls causing electrical damage.
5. Do not install under a deck.
6. Do not install within 24" of any outdoor HVAC equipment.
7. Do not install where water may run-off a roof into the heater. A gutter may be needed to protect the heater.

USE ONLY HAYWARD GENUINE REPLACEMENT PARTS

- 8. If the heater is to be installed in front of an exterior wall with vinyl siding, increase the clearance from the back of the unit shown in Table 2 to 12 inches.
- 9. For minimum exhaust vent clearances for all building openings, including but not limited to vented eaves, doors, windows, or gravity inlets, see Figure 01. In Canada, the heater must be installed with the top of the vent at least 10 feet (3m) below, or to either side of, any opening into a building.

**Table 2
Outdoor Installation Clearances**

Heater Panel	Required Clearance
Top	Unobstructed
Front	18 inches
Back	6 inches
Water Connection Side	12 inches
Side Opposite Water Connection	6 inches

Figure 01: Minimum Clearances

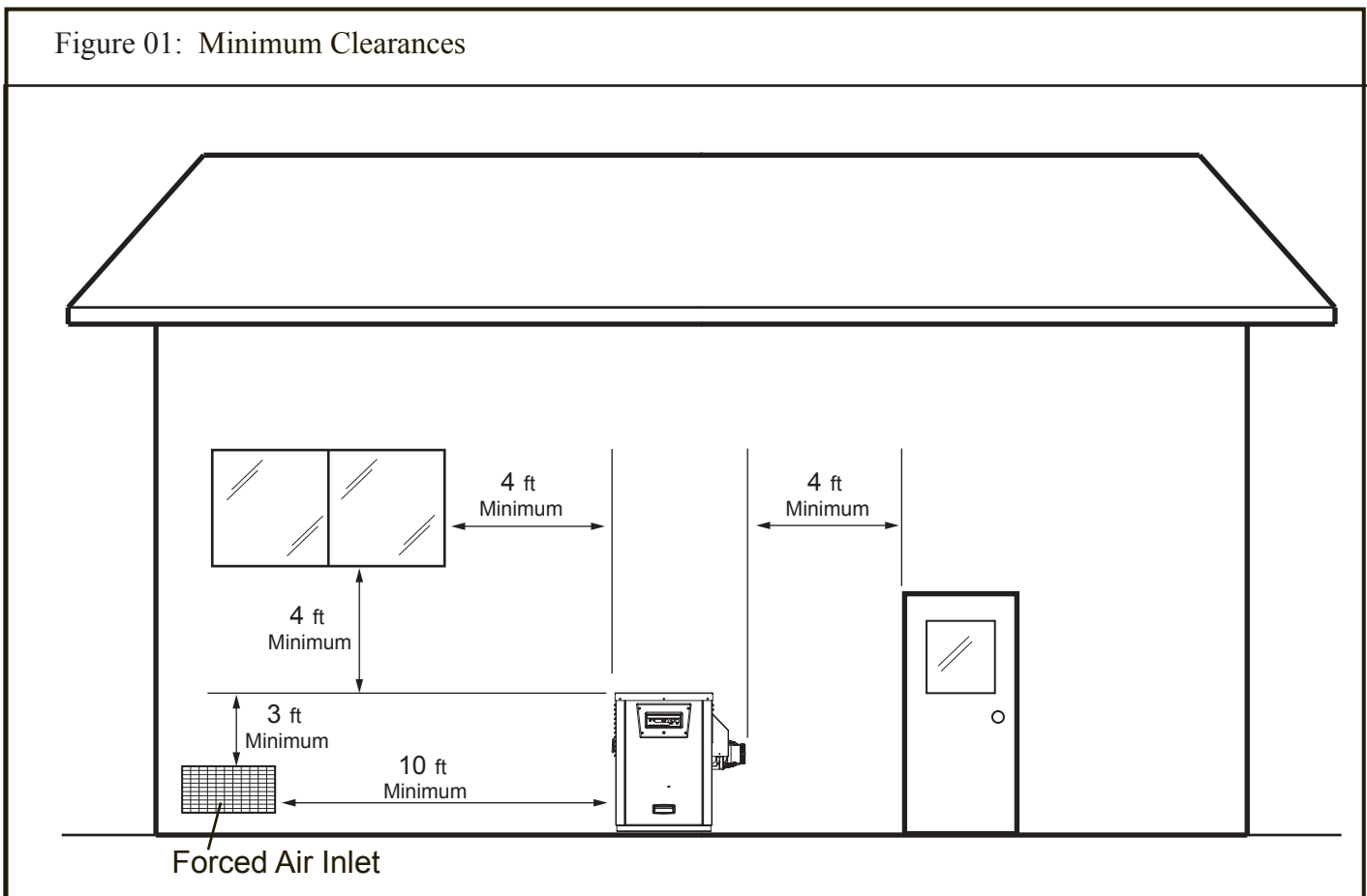

FLOORING:

This heater may be installed on either non-combustible or combustibile flooring. Ultralite™ or equivalent concrete-over-foam HVAC pads are acceptable.

USE ONLY HAYWARD GENUINE REPLACEMENT PARTS

Figure 02: Sub-Assemblies

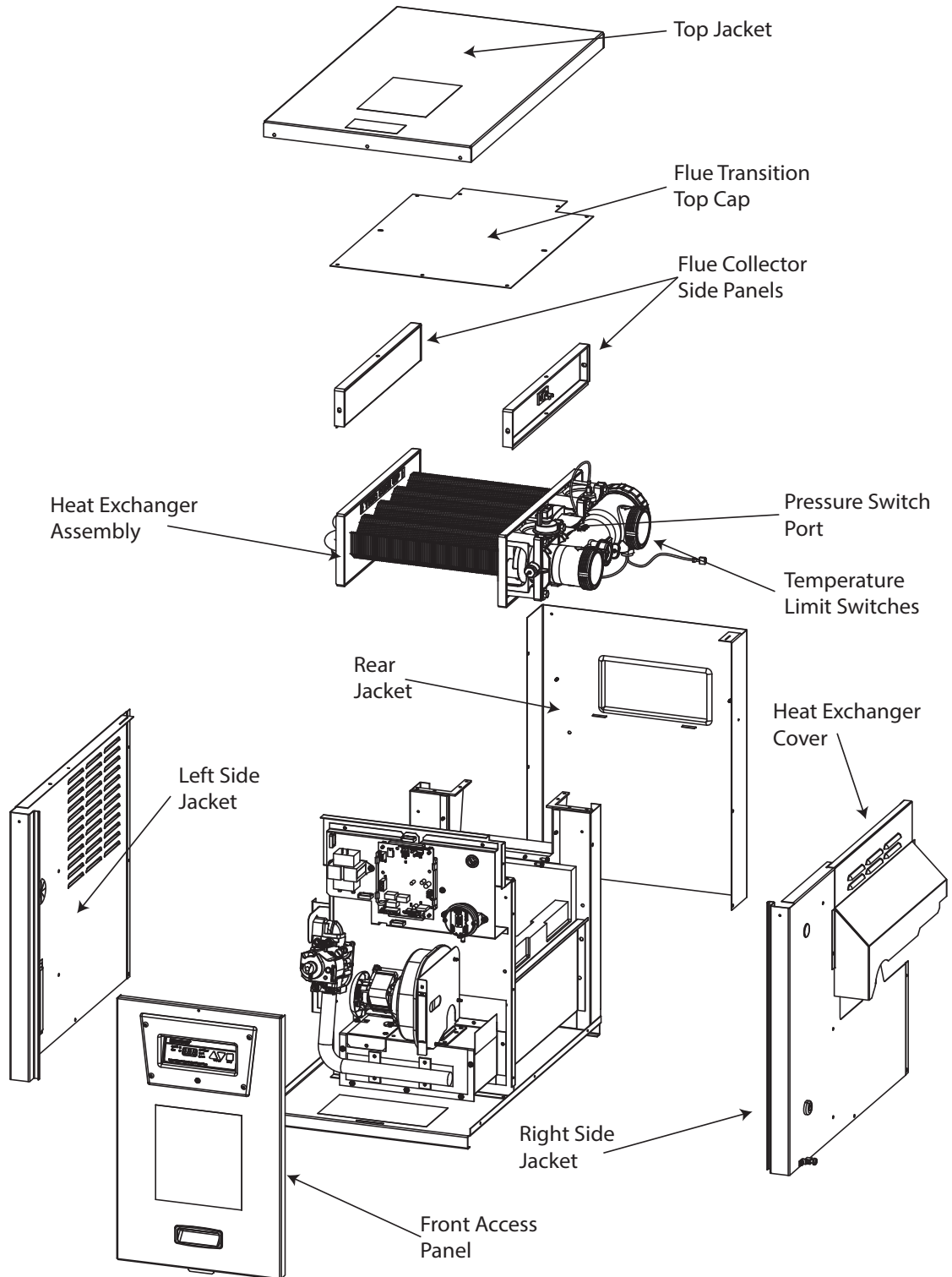

USE ONLY HAYWARD GENUINE REPLACEMENT PARTS

HOW TO OPEN FRONT ACCESS PANEL

! ATTENTION: Care must be taken to not damage ribbon cable connecting display board to ignition board when removing Front Access Panel.

1. Remove (1) screw above control, securing top jacket to front access panel.
2. Lift Access Panel up by the handle at the bottom.
3. Swing bottom of panel out.
4. Slide top of panel down, and then out. Be sure not to place too much tension on the ribbon cable as the front panel is removed from the unit
5. Disconnect ribbon cable from ignition board.

GAS SUPPLY AND PIPING:

To properly size the gas piping for the heater, refer to Tables 3 or 4, depending on natural or propane gas, and single-stage or 2-stage regulation. Follow local gas codes for proper gas line material selection (copper, iron, plastic, etc.). It is VERY IMPORTANT when installing a propane heater on a 2-stage regulation system to follow the gas line sizing data in Table 4 without exception.

Table 3
Gas Pipe Sizing
Low-Pressure, Single-Stage Regulation

Distance from Gas Meter or Tank Regulator Outlet to Heater Gas Valve Inlet	Gas Type	Natural Gas*	Propane**	
	btu/hr input	135,000	135,000	135,000
	Line Material	Iron or Plastic Pipe	Iron Pipe	Plastic Pipe
0 to 50 ft		3/4"	3/4"	3/4"
50 to 100 ft		1"	3/4"	1-1/8"
100 to 200 ft		1-1/4"	1"	1-1/8"
200 to 300 ft		1-1/4"	1"	1-1/8"

*Based upon an inlet pressure of 0.5 psig or less at a pressure drop of 0.5 in-wc.

**Based upon an inlet pressure of 11 in-wc at a pressure drop of 0.5 in-wc.

Table 4
Gas Pipe Sizing
High-Pressure, 2-Stage Regulation

Distance from Gas Meter or Tank Regulator Outlet to Heater Gas Valve Inlet	Gas Type	Natural Gas	Propane	
	btu/hr input	135,000	135,000	135,000
	Line Material	Iron or Plastic Pipe	Iron Pipe	Plastic Pipe
First Stage	0 to 50 ft	1/2" *	1/2" ***	1/2" ***
	50 to 100 ft	1/2" *	1/2" ***	1/2" ***
	100 to 150 ft	1/2" *	1/2" ***	1/2" ***
Second Stage	0 to 10 ft	1/2" **	1/2" ****	5/8" ****

*Based upon an inlet gas pressure of 2 psig at a pressure drop of 1 psi.

**Based upon an inlet gas pressure of 10 in-wc at a pressure drop of 0.5 in-wc.

***Based upon an inlet gas pressure of 10 psig at a pressure drop of 1 psi.

****Based upon an inlet gas pressure of 11 in-wc at a pressure drop of 0.5 in-wc.

USE ONLY HAYWARD GENUINE REPLACEMENT PARTS

GAS SUPPLY INSTALLATION:

The gas connection is located on the left-hand side of the heater cabinet. Insert the pipe to the gas valve through the grommet in the cabinet side (see Figure 3.) A union should be installed outside the heater cabinet for easy removal of the gas manifold assembly during service.

A CSA certified main gas shutoff valve must be installed outside the cabinet and within 6 feet of the heater. This valve must have an I.D. large enough to supply the proper amount of gas volume to the heater. See Figure 4.

⚠ ATTENTION: Apply joint compound (pipe dope) sparingly and only to the male threads of pipe joints. Do not apply joint compound to the first two threads. Use joint compounds resistant to the action of liquefied petroleum gas. Do not overtighten the gas inlet pipe or damage may result.

⚠ ATTENTION : Do not use flexible appliance connectors on any gas connections unless the connector is CSA approved for outdoor installation, is marked with BTUH capacity (which must be equal to or greater than the heater rated input) and the type of gas (natural or LP).

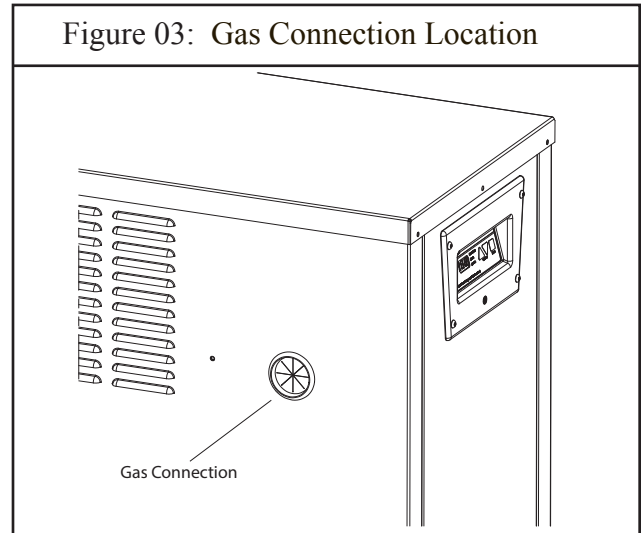

Reduction of gas supply pipe or tubing to the inlet of the heater gas valve must be made at the valve only and must match the valve inlet size (3/4" NPT).

If more than one appliance is installed on the gas line, consult the local gas company for the proper gas line size.

Questions on the installation of the proper gas line size can be directed to Hayward Technical Service.

NATURAL GAS:

The gas meter must have the capacity to supply enough gas to the pool heater and any other gas appliances if they are on the same pipeline (Example: 225 meter = 225,000 BTUH). If doubt exists as to the meter size, consult the local gas utility for assistance. Natural gas must be "pipeline quality" supplied from a natural gas utility company. Hayward will not be responsible for heaters that soot up due to improper meter and gas line sizing resulting in improper gas volume, or heaters that are damaged in any way if connected to a natural gas well.

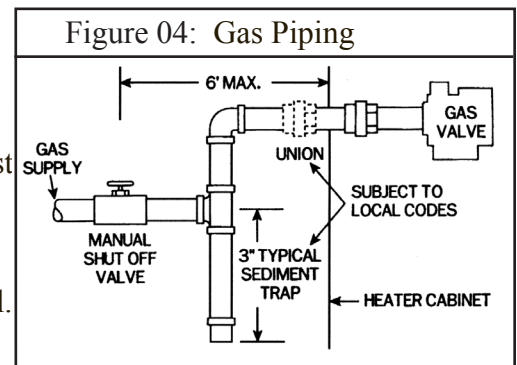

PROPANE GAS:

All propane gas tanks must be located outdoors and away from pool/spa structure and in accordance with the standard for storage and handling of propane gas, ANSI/NFPA 58 (latest edition) and applicable local codes. If the propane gas tank is installed underground, the discharge of the regulator vent must be above the highest probable water level.

Propane tanks must have sufficient capacity to provide adequate vaporization for the full capacity of the equipment at the lowest expected temperatures. Consult a propane company expert for correct sizing.

USE ONLY HAYWARD GENUINE REPLACEMENT PARTS

ATTENTION: Whenever a high-pressure double regulation system is utilized for propane gas, consult a propane expert for accurate pipe and pressure sizing. Make sure that 1st and 2nd stage regulators are large enough to handle the BTUH input listed for the heater(s) being used. Hayward will not be responsible for heaters that soot up due to improper gas line or propane tank sizing resulting in improper gas volume.

WATER PIPING:

The heater is designed for use with pool and spa/hot tub water only, as furnished by municipal water distribution systems. The warranty does not cover heater use with mineral water, seawater (PPM>5000), or other non-potable waters.

Do not install any restriction in the water pipe between the heater outlet and the pool/spa with the exception of:

1. three-way switching valve
2. in-line chlorinator
3. chlorinator check valve

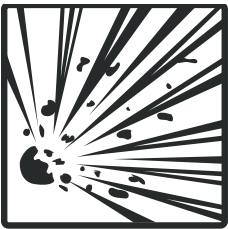

WARNING: EXPLOSION HAZARD Blockage of water flow from heater return to pool may result in fire or explosion causing property damage, personal injury, or loss of life.

The heater is shipped with CPVC flanged pipe nipples and the required reducer to be used with the supplied 1.5" flexible hose fittings. Assemble all water connection components as shown in Figure 05. Assemble these parts to the heater prior to plumbing. Tighten all nuts securely, ensuring a seal with the rubber gaskets, before connecting flexible hose.

The CPVC flanged pipe nipples and reducers must be installed on the heater inlet and outlet without modification. Pipe, fittings, valves, and any other element of the filter system may be made of plastic materials, if acceptable to the authority having jurisdiction.

Installation of this pool/spa/hot tub heater with rigid PVC pipe plumbed directly to the inlet and outlet connections of the heater requires purchase of Hayward accessory Union Kit SPX3200UNKIT. The kit contains the appropriate gaskets, pipe nipples and union nuts to allow 2" or 2 1/2" PVC pipe to be plumbed to the unit. Use PVC primer and glue to connect water piping to the connectors supplied in the kit.

Heat sinks, heat tapes, firemen switches, and check valves are not required on the heater. However, if there is any chance of "back-siphoning" of hot water when the pump stops running, it is suggested that a check valve be used on the heater inlet pipe.

The built-in bypass inside the header will maintain proper flow through the heat exchanger if the flow rate

Figure 05: Water Connection Assembly

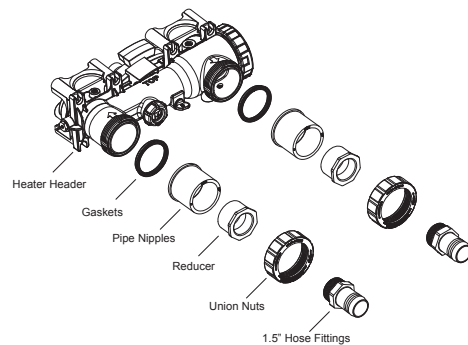
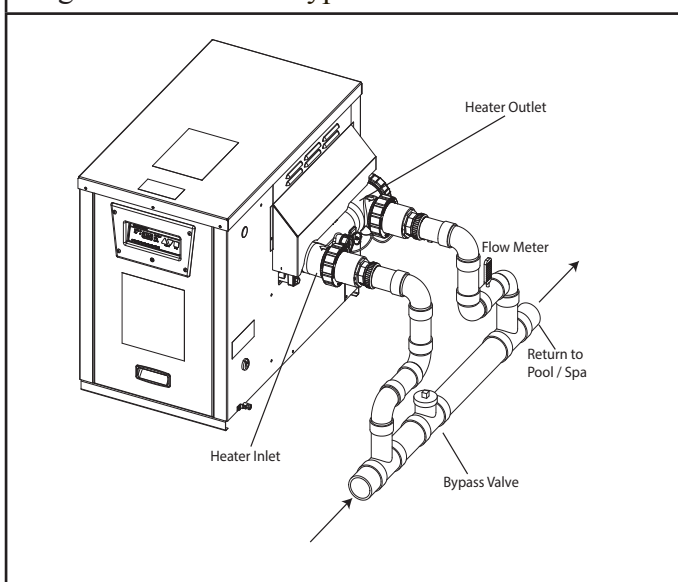

Figure 06: Manual Bypass valve



USE ONLY HAYWARD GENUINE REPLACEMENT PARTS

is within the range for the heater. See Table 5. The minimum flow rate is to be calculated or measured with the in-floor cleaning system in use, if the pool is so equipped, as well as any other jets or other demands on the water flow.

If the normal pump and filter system flow rate exceeds 125 gpm then a manual bypass valve must be installed as shown in Figure 06. Damage caused by flow rates outside this range will void the manufacturer's warranty.

The installation is as follows:

1. Install a flow meter on the outlet line of the heater.
2. Adjust the manual bypass valve until the flow rate is within the flow rate range specified for the heater.
3. Once the valve is set, note the position and remove the valve handle to prevent further adjustment.

ATTENTION: Improperly adjusted manual bypass valves will result in damage to the heater if the flow rates are not maintained as specified in Table 5 under all operating conditions. The heat exchanger will fail and this damage will not be covered under the Hayward warranty.

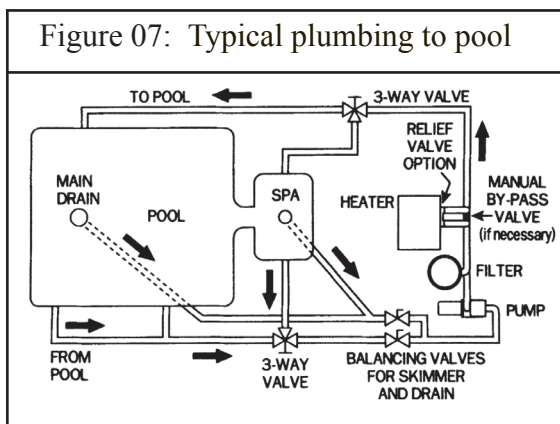

Figure 07 illustrates a typical pool piping diagram and layout for the pool equipment.

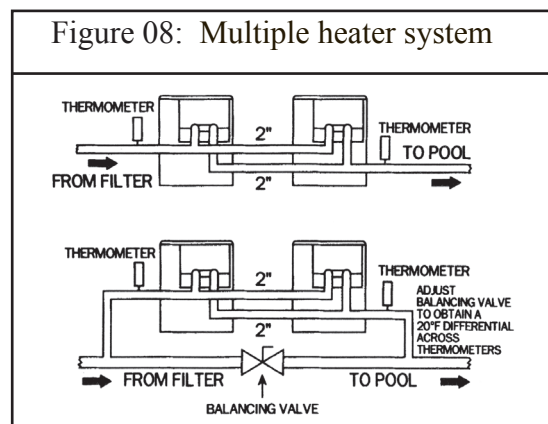

Figure 08 illustrates a multiple heater installation for very large pools with and without a manual bypass valve.

INSTALLATION ABOVE/BELOW WATER SURFACE:

If the heater is installed less than three (3) feet above the surface of the pool/spa water, install eyeball fittings or directional flow fittings on the end of the return water line to the pool/spa to create adequate back pressure at the heater to operate the pressure safety switch when the filter pump is running.

If the heater is installed more than three (3) feet above the surface of the pool/spa water, install a loop as shown in Figure 09 to prevent drainage of water in the heater during a filter change.

For installation below the pool/spa surface, refer to Section III.

Figure 09: Heater installation above pool/spa

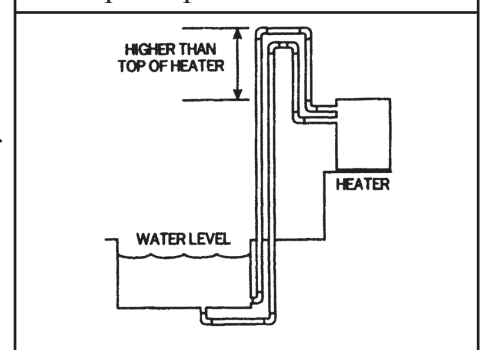

USE ONLY HAYWARD GENUINE REPLACEMENT PARTS

AUTOMATIC CHLORINATORS AND CHEMICAL FEEDERS:

If used, a chlorinator must be installed downstream from the heater in the pool return line and at a lower elevation than the heater as shown in Figure 10. Install a separate positive seal corrosion resistant check valve between the heater outlet and the chlorinator to prevent highly concentrated sanitizer from back siphoning into the heater. Back siphoning usually occurs when the pump is shut off and a pressure differential is created.

PRESSURE RELIEF VALVE:

Some local building codes require a pressure relief valve for all pool/spa heaters. The inlet/outlet header has a 3/4" port which can be used for this purpose (see Figure 11 for location of port). A 3/4" pressure relief valve having a discharge capacity greater than or equal to the Btu/hr input of the heater, and a pressure rating equal to or less than the working pressure is recommended. See the rating plate located inside the front access panel on the heater for the input rating and working pressure. If desired, you may order the pressure relief valve from Hayward; order p/n CHXRLV1930. Remove the factory-installed pipe plug, and install the pressure relief valve using a suitable amount of pipe thread sealant or Teflon tape on the threads. Install the pressure relief valve with the discharge connection facing the ground. If necessary, connect a pipe (of the same size as the valve outlet) to the outlet and run it to a safe place of discharge. Do not install any shut-off or restriction in this drain line.

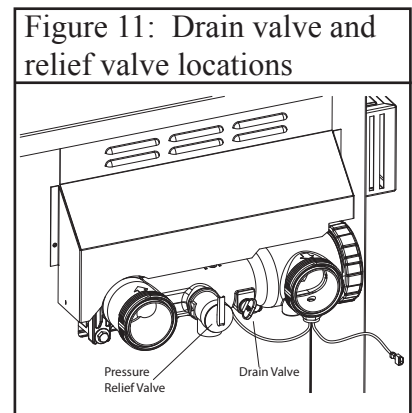
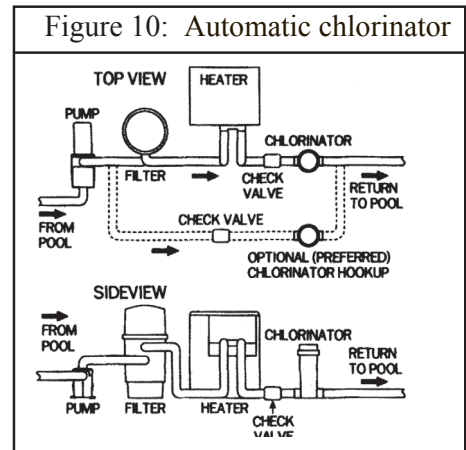

ELECTRICAL SPECIFICATIONS:



WARNING: It is required that licensed electricians do all electrical wiring. **Risk of Electric Shock.** Hazardous voltage can shock, burn, and cause death or serious property damage. To reduce the risk of electric shock, do NOT use an extension cord to connect unit to electric supply. Provide a properly located electrical receptacle. All electrical wiring MUST be in conformance with applicable local and national codes and regulations. Before working on heater, turn off power supply.

GENERAL INFORMATION:

Wiring connections must be made as shown in the wiring diagram found inside the heater cabinet, and as shown in Figure 13. The heater must include a definite means of grounding and bonding. There is a ground lug on the control panel and a bonding lug on the side of the heater.

MAIN POWER:

WARNING - Power connections supplied to the heater must be in accordance with National Electric Code (NEC) and local electric codes. The NEC contains no standards requiring Ground-Fault Interruption protection (via GFI Circuit Breaker or otherwise) of "Fixed" or "Stationary" equipment, under article 680: Swimming Pools, Fountains, & Similar Installations.

USE ONLY HAYWARD GENUINE REPLACEMENT PARTS

BONDING:



CAUTION - This heater must be connected to a bonding grid with a solid copper conductor wire gauge 8 AWG or larger. All Hayward heaters are designed for copper conductors only. The National Electrical Code (NEC), and most other codes require that all metallic components of a pool structure, including reinforcing steel, metal fittings and above ground equipment, be bonded together with a solid copper conductor wire gauge 8 AWG or larger. The heater, along with pumps and other pool equipment must be connected to this bonding grid. A bonding lug is provided on the side of the heater to ensure that this requirement is met.

ELECTRICAL CONNECTIONS:

The heater is equipped with a hot surface ignition control system that automatically lights the burners. An external power supply is required to power the control system. The electrical specifications for this heater are 120 vac, 60Hz, 1-phase, 5.5A maximum current. It is recommended that circuit protection for the heater circuit be rated at 15 Amperes.

REMOTE CONTROL CONNECTION:

The heater is capable of connection to an external 2-wire remote thermostat or to a 3-wire remote switch. A 2-wire thermostat has its own temperature sensor for regulating water temperature. A 3-wire remote switch allows the POOL or SPA modes to be remotely selected.

The remote wiring harness can be found in the vinyl pouch assembly below the gas valve. Plug the harness into the ignition board as shown in Figure 12. Replace the plastic plug on the right side of the heater with the supplied star bushing and run remote wiring through the bushing to the external thermostat or switch. Use 3/16" male quick connects to attach field supplied wiring to remote harness.

2-WIRE REMOTE CONTROL CONNECTION:

To configure the heater for 2-wire remote thermostat control, use the MODE key on the heater keypad to put the control into STANDBY mode. Then press and hold both the DOWN and MODE keys for 3 seconds until the display shows the code "bo".

On the remote control wiring harness (Figure 12), connect the appropriate wires from the remote control to the ORANGE wire (POOL) and WHITE wire (24V).

To operate the heater by remote thermostat, the heater's control must be in either POOL or SPA mode. The display will show "bo". The POOL or SPA LED will be illuminated. The remote thermostat will operate the heater. The heater's thermostat will function to limit the water temperature to a maximum of 104°F.

3-WIRE REMOTE CONTROL CONNECTION:

In the remote control wiring harness (Figure 12), connect the appropriate wires from the remote control to the ORANGE wire (POOL), WHITE wire (24V), and RED wire (SPA). To operate the heater with a remote 3-wire switch, the heater's control must be in STANDBY mode. The STANDBY LED will be illuminated. When the remote switch is set to "Pool/Low" the POOL LED will be illuminated and the water temperature will be displayed. When the remote switch is set to "Spa/High" the SPA LED will be illuminated and the water temperature will be displayed. The heater will use its internal thermostat to regulate the water temperature to the set point of the mode selected.

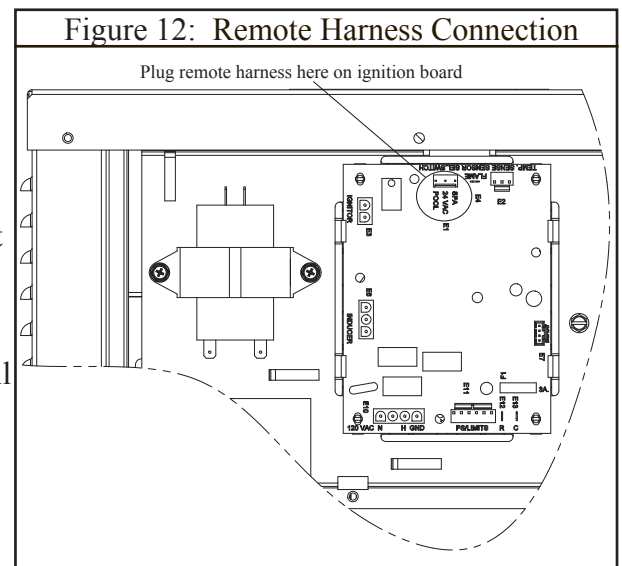

USE ONLY HAYWARD GENUINE REPLACEMENT PARTS

Wiring Connection Diagram / Schéma de Connexion de Câblage

Forced Draft Gas Heaters / Chaudière Gas à Air Pulsé

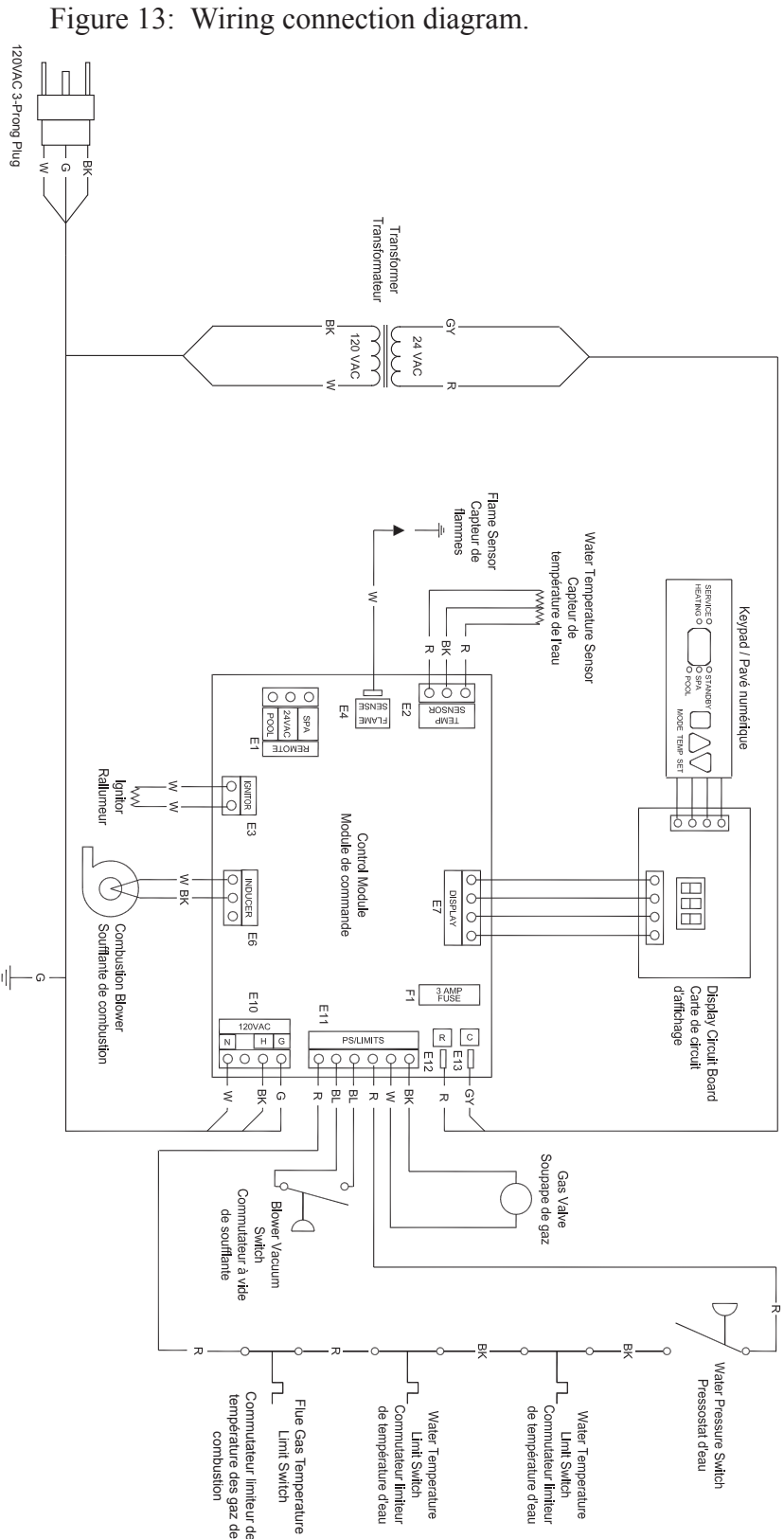

NOTE:
1. If any of the original wire supplied with the heater must be replaced, it must be replaced with 18 AWG, UL or CSA approved wire, rated for 600V and 105°C.

REMARQUE:
1. Si l'un des fils fournis avec le réchauffeur doit être remplacé, il faut le remplacer par un fil de calibre 18 AWG, approuvé UL ou CSA, homologué pour 600 V et 105°C.

USE ONLY HAYWARD GENUINE REPLACEMENT PARTS

Figure 14:
Lighting &
Operating
Instructions
label

FOR YOUR SAFETY READ BEFORE LIGHTING

WARNING: If you do not follow these instructions exactly, a fire or explosion may result causing property damage, personal injury or loss of life.

- This appliance does not have a pilot. It is equipped with an ignition device which automatically lights the burners. Do **not** try to light the burners by hand.
- BEFORE LIGHTING** smell all around the appliance area for gas. Be sure to smell next to the floor because some gas is heavier than air and will settle on the floor.

WHAT TO DO IF YOU SMELL GAS

 - Do not try to light any appliances.
 - Do not touch any electric switch; do not use any phone in your building.
 - Immediately call your gas supplier from a neighbor's phone. Follow the gas supplier's instructions.
 - If you cannot reach your gas supplier, call the fire department.
- Use only your hand to turn the gas control knob. Never use tools. If the knob will not turn by hand, don't try to repair it; call a qualified service technician. Force or attempted repair may result in a fire or explosion.
- Do not use this appliance if any part has been under water. Immediately call a qualified service technician to inspect the appliance and to replace any part of the control system and any gas control which has been under water.
- Should over-heating occur, or the gas supply fails to shut off, turn off manual gas valve to the appliance.

POUR VOTRE SÉCURITÉ LIRE AVANT L'ALLUMAGE

MISE EN GARDE: Si vous ne suivez pas exactement ces instructions, un incendie ou une explosion pourrait survenir et causer des dommages à la propriété, des blessures corporelles ou la perte de la vie.

- Cet appareil n'a pas de pilote. Un mécanisme d'allumage automatique pour les brûleurs. **N'essayer** pas d'allumer les brûleurs à la main.
- AVANT L'ALLUMAGE**, sentir tout autour de l'appareil pour détecter d'éventuelles odeurs de gaz. S'assurer de sentir près du plancher parce que les gaz plus lourds que l'air, se concentrent au niveau du plancher.

QUE FAIRE EN PRÉSENCE D'ODEURS DE GAZ:

 - Ne pas essayer d'allumer l'appareil.
 - Ne pas toucher à un commutateur électrique; Ne pas utiliser le téléphone dans la maison.
 - Appeler immédiatement fournisseur de gaz chez un voisin. Suivre les instructions du fournisseur de gaz.
 - Si le fournisseur ne peut pas être atteint, appeler le service des incendies.
- Utiliser uniquement les mains pour actionner les boutons de commande du gaz. Ne jamais utiliser d'outils. Si le bouton ne s'enfonce pas ou ne se tourne pas à la main, ne pas essayer de le réparer. Appeler un technicien qualifié. L'utilisation de la force ou une tentative de réparation pourrait causer un incendie ou une explosion.
- Ne pas utiliser cet appareil si une des composantes a été immergée dans l'eau. Appeler immédiatement un technicien qualifié pour vérifier l'appareil et remplacer toute composante du système de commande ou de gaz qui aurait été immergée dans l'eau.
- Si le système surchauffait ou si le gaz refusait de se fermer, placer le robinet d'arrêt manuel de gaz de l'appareil en position "FERMÉ" (OFF).

OPERATING INSTRUCTIONS

- STOP!** Read the safety information on this label.
- Change the "MODE" on the control panel to "STANDBY".
- Remove the heater's front access panel.
- This appliance is equipped with an ignition device which automatically lights the burner. Do not try to light the burners by hand.
- Turn gas control knob clockwise  to "OFF".

GAS CONTROL
KNOB SHOWN
IN "OFF"
POSITION



- Wait five (5) minutes to clear out any gas. If you then smell gas, STOP! Follow "B" in the

- safety information on this label. If you don't smell gas, go to the next step.
- Turn gas control knob counterclockwise to "ON".
 - Replace the heater's front access panel.
 - Set the "MODE" on the control panel to "SPA" or "POOL".
 - Set the set point temperature on the control panel to the desired setting.
 - If the appliance does not operate, repeat steps 2 thru 10. If the appliance still does not operate, follow instructions "TO TURN OFF GAS TO APPLIANCE" and call your service technician or gas supplier.

TO TURN OFF GAS TO APPLIANCE

- Change the "MODE" on the control panel to "STANDBY".
- Remove the heater's front access panel.
- Turn the gas control knob clockwise  to "OFF".
- Replace the heater's front access panel.

INSTRUCTIONS D'ALLUMAGE

- STOP!** Lire les consignes de sécurité sur cette étiquette.
- Changer le MODE du tableau de commande à STANDBY.
- Retirer le panneau d'accès avant de l'appareil de chauffage.
- Cet appareil est pourvu d'un dispositif d'allumage qui allume automatiquement les brûleurs. Ne pas tenter d'allumer manuellement les brûleurs.
- Tourner le bouton de commande du gaz en sens  horaire à OFF (fermé).

BOUTON DE
COMMANDE
DE GAZ MONTRÉ
EN POSITION
"FERMÉ" (OFF)



- Attendre cinq (5) minutes que tout gaz se dissipe. Arrêter si l'on sent alors une odeur de gaz. Suivre B dans les consignes de sécurité de cette étiquette.

- Passer à l'étape suivante en l'absence d'odeur de gaz.
- Tourner le bouton de commande du gaz en sens anti-horaire à ON (OUVERT). 
 - Remplacer le panneau d'accès avant de l'appareil de chauffage.
 - Régler le MODE du tableau de commande à SPA ou à POOL.
 - Établir la valeur de réglage sur le tableau de commande à la température désirée.
 - Si l'appareil ne fonctionne pas, répéter les étapes 2 à 10. Si l'appareil refuse toujours de "FERMÉ" fonctionner, dissipe. Suivre les instructions *Pour tourner le gaz à l'appareil* et appeler votre technicien de service ou votre fournisseur de gaz.

POUR FERMER LE GAZ SUR L'APPAREIL

- Changer le MODE du tableau de commande à STANDBY.
- Retirer le panneau d'accès avant de l'appareil de chauffage.
- Tourner le bouton de commande du gaz en sens horaire  à OFF (fermé).
- Remplacer le panneau d'accès avant de l'appareil de chauffage.

GENERAL:

Some of the following procedures will require the heater to be operating. Full lighting and shutdown instructions are included on the lighting and operating label affixed to the inside of the front access panel. The heater automatically lights in response to a call for heat, and automatically shuts down when that call for heat is satisfied.

Water must be flowing through the heater during operation. Check that the pump is operating and the system is filled with water and purged of all air prior to starting the heater.

Figure 15: Location of Components

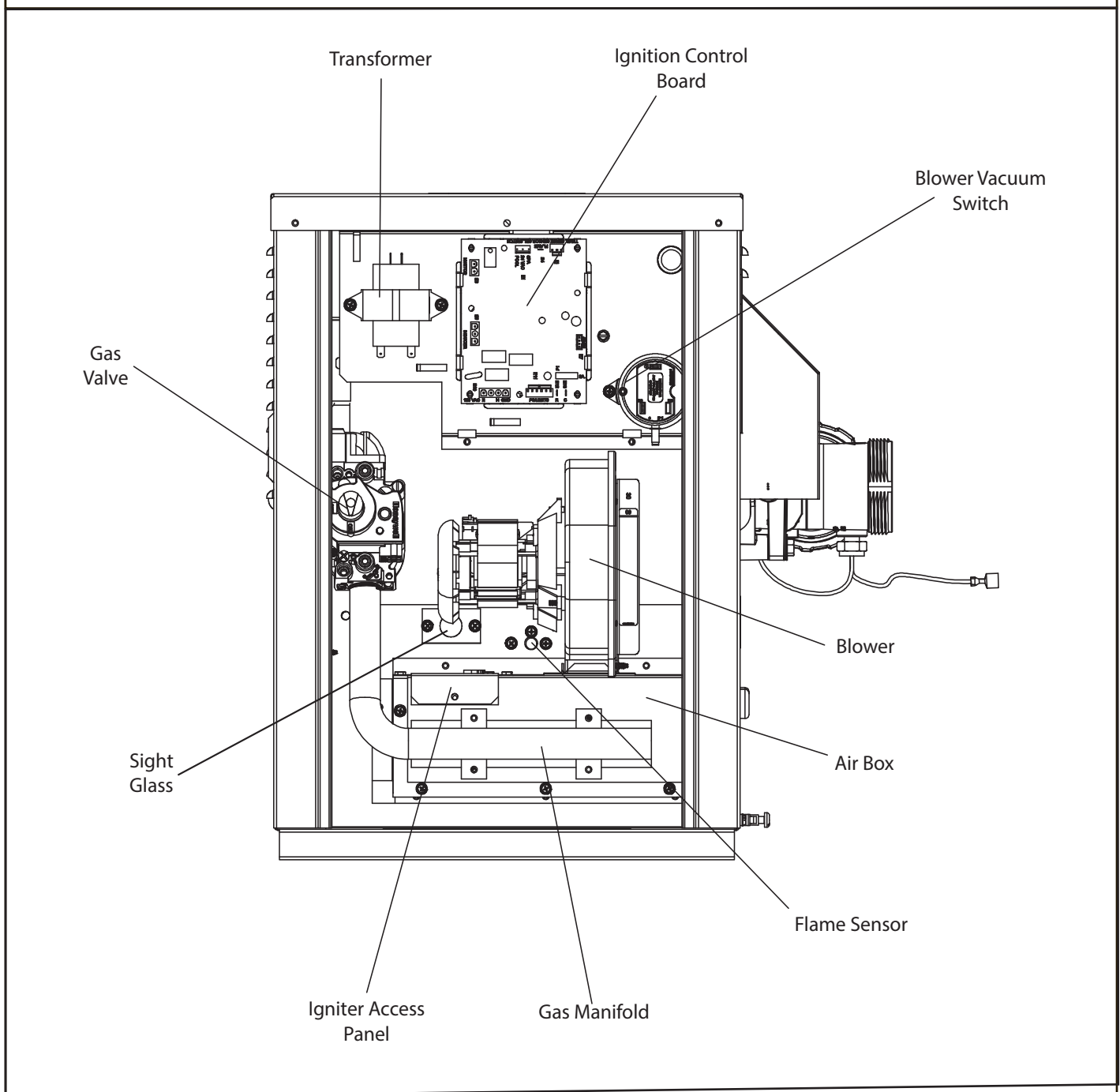

USE ONLY HAYWARD GENUINE REPLACEMENT PARTS

GAS LINE TESTING:

The appliance and its gas connection must be leak tested before placing the appliance in operation. The heater and its individual shutoff valve must be disconnected from the gas supply during any pressure testing of that system at test pressure in excess of ½ psig (3.45 kPa). The heater must be isolated from the gas supply piping system by closing its individual manual shutoff valve during any pressure testing of the gas supply piping system at test pressure equal to or less than ½ psig (3.45 kPa).

Gas supply line must be capped when not connected. After pressure testing, reconnect the gas piping to the gas valve. Turn gas supply ON and test all pipe and tubing joints for leaks. Use a soap and water solution.

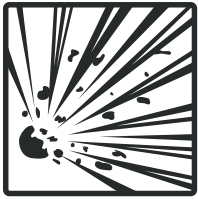

WARNING: EXPLOSIVE HAZARD. The use of an open flame to check for gas leaks could cause an explosion resulting in severe injury and/ or death. Shut off gas and fix even the smallest leak right away. Be sure to leak test the heater gas manifold fittings using the above procedure once the heater is in operation.

GAS PRESSURE TESTING:

The following gas pressure requirements are important to the proper operation of the burners in gas heaters. Improper gas pressure or gas volume will create the following conditions:

1. Flame burns totally yellow.
2. Flame lifts off burner.
3. Heat exchanger soots up. The gas pressure regulator on all heaters is preset at the factory, but the setting should be verified by the installer to ensure proper operation.

If gas pressure is inadequate, check for undersize piping between the gas meter and the heater or for a low-capacity gas meter.

GAS PRESSURE TEST PROCEDURE:

Refer to Figure 16 for the location components used in this procedure.

1. Obtain the necessary equipment:
 - a. Manometer to read pressure in inches of water column
 - b. 1/8" pipe nipple (1/8" thread x 1" long)
 - c. 3/16" hex wrench
 - d. Flat screwdriver
2. Remove the 1/8" plug from the gas valve.
3. Install the 1/8" pipe nipple into the gas valve.
4. Attach the manometer to the pipe nipple.
5. Turn on the water system and start the heater following the lighting & operating instructions on the label affixed inside the front access panel. If there is more than one pool/spa heater connected to the gas supply line, turn each of those appliances ON while testing the heater.
6. Take a pressure reading with the heater running, the value should agree with those in Table 6. If the pressure is within the range of 1.8" - 2.0" w.c. (natural) or 6.8" - 7.0" w.c. (propane), then no further adjustment is needed.
7. If the gas pressure does not meet the above requirements the regulator must be adjusted.

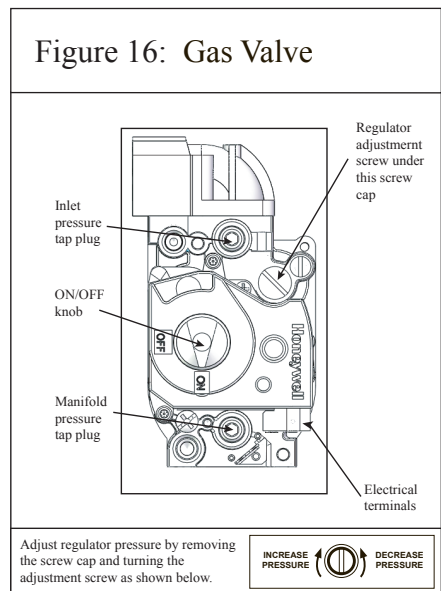

USE ONLY HAYWARD GENUINE REPLACEMENT PARTS

8. Gas pressure regulator adjustment procedure:
 - a. Remove the screw cap over the regulator adjustment screw (see Figure 16).
 - b. Turn the regulator adjustment screw clockwise to increase pressure and counterclockwise to decrease pressure.
 - c. Replace the screw cap over the regulator adjustment screw.

Pressure, in. w.c.	H1351D1, ABG1351	H1351DP1, ABG135P1
Fuel	Natural	Propane
Manifold	1.8" - 2.0" w.c.	6.8" - 7.0" w.c.
Inlet, minimum	4.5" w.c.	10.0" w.c.
Inlet, maximum	10.5" w.c.	13.0" w.c.

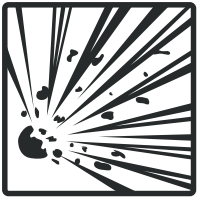

WARNING EXPLOSION HAZARD: Do not remove the 1/8" pipe nipple with the valve in the ON position. The valve must be in the OFF position when the nipple is removed. Removal of the nipple with the gas valve ON could cause an explosion resulting in severe injury and/or death.

9. Remove the 1/8" pipe nipple and replace the 1/8" pipe plug. If proper pressure cannot be achieved by adjusting the gas valve regulator, the installer must contact the gas supplier and request that the inlet pressure to the heater be set to within the gas pressure range shown in Table 6.

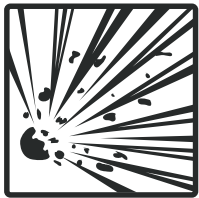

WARNING EXPLOSION HAZARD: Gas pressures in excess of those listed in Table 6 could cause a gas leak or diaphragm rupture. Gas leakage could cause an explosion resulting in severe injury or death.

WATER PRESSURE SWITCH TEST / ADJUSTMENT PROCEDURE:

The pressure switch is preset at the factory for most typical, deck level installations. When the heater is located above or below the level of the pool or spa, the pressure switch may require adjustment to compensate for the change in static head pressure. The following procedure is recommended when the switch needs adjustment and/or is replaced:

For Installations with Heater Above Water Level:

1. Be sure the filter is clean before making the adjustment.
2. Turn "ON" the filter pump and ensure all air is out of the water lines, and ensure water flow rate is at least the rated minimum (see Table 5).
3. Turn "ON" the heater and adjust the thermostat to create a call for heat.
4. If the heater does not light, adjust the pressure switch by turning the adjustment knob on the pressure switch counter-clockwise, until the heater lights. Turning the adjustment knob counterclockwise decreases the pressure needed to close the switch.
5. Check the function of the pressure switch by turning the filter pump on and off several times. The pool heater should turn off immediately when the pump is turned off. Never allow the heater to operate with less than the minimum rated water flow rate.

USE ONLY HAYWARD GENUINE REPLACEMENT PARTS

For Installations with Heater Below Water Level:

1. Be sure the filter is clean before making the adjustment.
2. Turn ON the filter pump and ensure all air is out of the water lines, and ensure water flow rate is at least the rated minimum (see Table 5).
3. Turn ON the heater and adjust the thermostat to create a call for heat.
4. Turn the adjustment knob on the pressure switch clockwise, until the heater turns off, then turn the knob $\frac{1}{4}$ turn counter-clockwise, so that the heater turns back on. Turning the adjustment knob clockwise increases the pressure needed to close the switch.
5. Check the function of the pressure switch by turning the filter pump on and off several times. The pool heater should turn off immediately when the pump is turned off. Never allow the heater to operate with less than the minimum rated water flow rate.

TWO-SPEED PUMP:

In a few cases the pressure from a two-speed pump is below the 1- pound minimum required to operate the water pressure switch on the heater. This is apparent when the pressure switch cannot be further adjusted. In these cases the pump must be run at high speed to operate the heater. If the pump and piping arrangement are such that the required 1-pound minimum pressure cannot be obtained, do not attempt to operate the heater. Correct the installation.

USE ONLY HAYWARD GENUINE REPLACEMENT PARTS

TEMPERATURE ADJUSTMENT:

This pool heater is equipped with a digital thermostat which allows the user to select the desired water temperature. The heater will then function automatically to maintain the desired temperature. The heater has 3 modes of operation:

1. **STANDBY:** in this mode, the heater will not function to heat the water.
2. **SPA:** in this mode, the heater will automatically function to maintain the water temperature setting for SPA mode.
3. **POOL:** in this mode, the heater will automatically function to maintain the water temperature setting for POOL mode.

Use the **MODE** button to change modes. The indicator lights will illuminate to show which mode the heater is currently in. Each mode has its own temperature setting, allowing the user to have 2 individual pre-set temperature settings. To adjust the temperature while in SPA or POOL mode, use the **UP** and **DOWN** buttons. The numeric display will flash to indicate the temperature setting is being displayed / adjusted. When the numeric display is not flashing, the actual water temperature is being displayed. The temperature settings for both SPA and POOL modes are initially set at the factory to 65°F. The minimum allowed settings for SPA and POOL modes are both 65°F. The maximum allowed settings for SPA and POOL modes are adjustable up to 104°F using the temperature lockout feature (see page 25).

After selecting SPA or POOL mode or adjusting the temperature setting, it is normal for the heater to delay up to 10 seconds before the heater starts operating. This delay is an internal self-test of the heater. On occasion, the numeric display may show a diagnostic error code; refer to list of diagnostic error codes in Figure 21. Pressing the **MODE** button to cycle to **STANDBY** and back to SPA or POOL will clear a diagnostic error code. When clearing a diagnostic error code this way, it is normal for the heater to delay up to 5 seconds before resuming normal operation, assuming the diagnostic error code does not re-appear.

Figure 17: User Interface Keypad

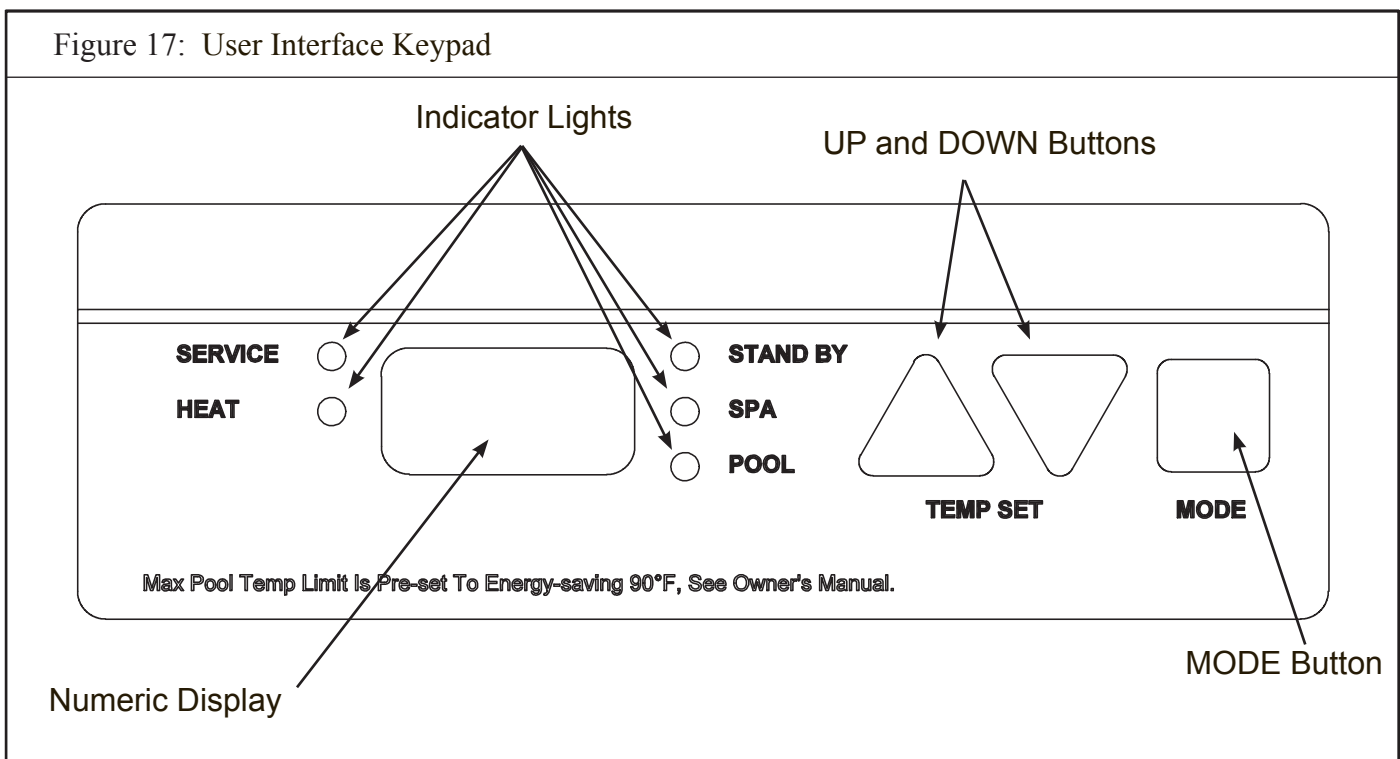

USE ONLY HAYWARD GENUINE REPLACEMENT PARTS

TEMPERATURE LOCK-OUT:

The digital thermostat in this pool heater allows the user to lock the maximum temperature setting allowed. This feature is useful for preventing unauthorized users from manually adjusting the temperature settings higher than desired. On a new heater, the maximum allowed temperature lock settings are initially set at the factory to 90°F for POOL mode, and 104°F for SPA mode. To adjust these settings, use the following procedure:

1. Use the MODE button to put the heater in STANDBY mode.
2. Press and hold both the UP and DOWN buttons at the same time.
3. After 3 seconds, the thermostat enters maximum temperature lock adjustment mode.
4. The SPA indicator light illuminates and the numeric display shows the current SPA mode maximum temperature lock setting. Both the SPA indicator light and the numeric display flashes rapidly when in adjustment mode.
5. Use the UP and DOWN buttons to set the desired maximum temperature lock setting. When finished, press the MODE button.
6. The POOL indicator light illuminates and the numeric display shows the current POOL mode maximum temperature lock setting. Both the POOL indicator light and the numeric display flashes rapidly when in adjustment mode.
7. Use the UP and DOWN buttons to set the desired maximum temperature lock. When finished, press the MODE button.
8. The heater will return to STANDBY mode

FAHRENHEIT VERSUS CELSIUS:

The temperature can be displayed in Fahrenheit or Celsius. To change the display, use the MODE button to place the heater in STANDBY. Then press and hold the UP and MODE buttons until the display shows the °F/°C selection. Press the DOWN button to toggle between selections. To accept the selection, press the MODE button. If the user does not act, the selection will be automatically accepted after 60 seconds.

HEATING MODE:

The control continually compares the water temperature with the set point and the high limit temperature. When the water temperature is more than 1° below the set point a call for heat is generated and a heating cycle is initiated.

1. The control checks for open contacts at the blower vacuum switch.
2. The control energizes the blower and the igniter. The igniter heat-up time is approximately 20 seconds. The blower is running a pre-purge cycle during this time.
3. The control checks for closed contacts at the blower vacuum switch.
4. When the igniter reaches the proper temperature a 4-second trial for ignition begins. The control opens the gas valve and monitors flame current. The igniter is turned off when flame is sensed or after 4 seconds.
5. The blower vacuum switch, the temperature limit switches, the water pressure switch, the water temperature sensors, and the flame sensor are constantly monitored during a call for heat to assure the heater is operating properly.
6. When the thermostat is satisfied and the call for heat ends the control immediately de-energizes the gas valve. Flame is extinguished.
7. The control operates the blower during a 30-second post-purge period.

USE ONLY HAYWARD GENUINE REPLACEMENT PARTS

FAILURE TO LIGHT – RETRY:

If the first ignition attempt fails during a normal heating cycle the control will make two (2) additional ignition attempts:

1. The control de-energizes the gas valve after the 4-second ignition trial ends.
2. The control operates the blower during a 30-second post-purge period.
3. The control monitors for open contacts at the blower vacuum switch.
4. The control performs a gas valve relay check.
5. A normal ignition sequence resumes with Item #2 in “Heating Mode” (page 25). If the third ignition trial fails the control enters a safety lockout (or “hard” lockout) after the post purge period of the third failed trial.
6. The error code “IF” is displayed and the SERVICE indicator is illuminated.
 - a. The control automatically resets and clears the “IF” error code without any user intervention after 60 minutes. If there is a call for heat after reset the control will make three (3) trials for ignition. If ignition is not established the control will again enter safety lockout for 60 minutes. This cycle will continue until ignition is established or the call for heat is removed.
 - b. The user can reset the control and clear the “IF” error code by pressing the MODE button to move through STANDBY and return to the previous mode (SPA or POOL).

LOSS OF FLAME – RECYCLE:

If flame is established and then lost, the control will make ten (10) attempts at ignition. If flame is lost within ten (10) seconds of ignition the control will respond within 2 seconds. If flame is lost more than ten (10) seconds after ignition the control will respond within 0.8 seconds.

1. The control de-energizes the gas valve and the blower.
2. The control monitors for open contacts at the blower vacuum switch.
3. The control performs a gas valve relay check.
4. A normal ignition sequence resumes with Item #2 in “Heating Mode” (page 25).
5. If the tenth ignition trial fails the control enters a safety lockout (or “hard” lockout) after the post-purge period of the tenth failed trial.
6. The error code “IF” is displayed and the SERVICE indicator is illuminated.
 - a. The control automatically resets after 60 minutes. If there is a call for heat after reset the control will make three (3) trials for ignition. If ignition is not established the control will again enter safety lockout for 60 minutes. If flame is established but is lost the control will make ten (10) attempts at ignition. This cycle will continue until ignition is established or the call for heat is removed.
 - b. The user can reset the control and clear the “IF” error code by pressing the MODE button to move through STANDBY and return to the previous mode (SPA or POOL).

KEYPAD INPUTS:

The control accepts user inputs via the keypad on the front panel.

1. When changing the mode from STANDBY to either SPA or POOL there may be up to a 10- second delay for the blower fan to begin running. The control performs an internal self-test and then verifies that the blower vacuum switch contacts are open before energizing the blower.
2. It is normal for the heater to display a 1- to 2-second delay in responding to any keypad input.
3. It is normal for the heater to display up to a 5-second delay when the keypad is used to reset the control to clear an error code.
4. The control will accept a mode change during lockout after 5 seconds. The control will continue to display the error code and remain in lockout until it is reset. At reset the control will go to the last saved mode.

USE ONLY HAYWARD GENUINE REPLACEMENT PARTS

AUTOMATIC RESET TIME:

The heater will automatically reset when an error condition is corrected and resume operation. The heater can be manually reset using the keypad by cycling the MODE button through STANDBY and back to the original operating mode (SPA or POOL).

PERIODIC INSPECTION:

The heater is designed and built for long performance life when installed and operated according to the manufacturer's directions. Regular inspection by qualified service personnel is recommended to keep the heater working properly. The following inspection points are suggested to help maximize heater life.

1. Periodically check the venting on outdoor heaters. The heater's venting area (the box on the rear of the heater) must never be obstructed in any way and minimum clearances must be observed to prevent restriction of combustion and ventilation air. Remember that shrubs grow and in time may obstruct a heater's venting areas.
2. Keep the entire pool heater area clean and free of all debris, combustible materials, gasoline, and other flammable vapors and liquids. Remove any leaves or paper from around the heater.
3. Do not store chlorine, other pool chemicals, or other corrosives in the vicinity of the heater.
4. If the heater is operating on propane gas, the tank must not fall below 30% full or damage to the heater may occur. Hayward will not be responsible for heaters that soot up due to improper gas level in the tank resulting in inadequate gas volume.
5. If another appliance is added to the gas line at a later date, consult the local gas company to be sure the gas line will have the capacity to supply both units at full input rating at the same time.
6. Do not use the heater if any part has been under water. Contact a qualified service technician to inspect the entire heater and replace any part of the control system or gas valve that was under water. If heater has been totally submerged in water it must be removed and the entire heater must be replaced.
7. An inspection program is a good preventative maintenance measure. Keep this manual in a safe place for future reference for yourself as well as for a service technician to consult when inspecting or servicing the heater. Additional inspection procedures to be performed by a qualified service technician are covered in Section IV of this manual.

WINTERIZATION:

In moderate climates, the heater can continue to operate during short-term cold spells. Do not use the heater to maintain the water temperature just above freezing or for freeze protection. Care must be taken to avoid freeze-up in the heater. When it is used during freezing weather, the pump must run continuously. The heater is not warranted against freeze-ups. In regions where freezing temperatures are encountered, all water must be drained from the heater when it is out of service, to prevent damage to the heater and piping. Draining the heat exchanger is recommended as part of the season's shutdown procedures.



ATTENTION: A heater damaged by freezing is not covered under the Hayward warranty.

USE ONLY HAYWARD GENUINE REPLACEMENT PARTS

DRAINING THE HEAT EXCHANGER:

This procedure applies to installations where the heater is located higher than the pool water level. If it is necessary to drain a pool heater located below the pool water level, you must either partially drain the pool, or isolate the pool heater from the pool using valves.

1. Set the heater to STANDBY mode using the keypad.
2. Turn the electricity to the heater OFF at the circuit breaker panel.
3. Turn the heater gas valve OFF using the knob or switch on the valve (see Figure 16).
4. Turn the heater's gas supply OFF at the main shut-off valve outside the heater cabinet.
5. Be sure the circulating pump is OFF.
6. Remove the plastic drain plug (see Figure 18).
7. Allow all water to drain from the heater.
8. Re-install the plastic drain plug.

SPRING START-UP:

1. Inspect and clean the heater, being sure the heater is free of leaves and debris prior to startup.
2. Be sure inlet and outlet piping are properly attached to the heater and the drain valve is closed.
3. Turn the filtration system pump ON and allow the system to run long enough to purge all the air from the lines.
4. Turn the gas supply to the heater ON.
5. Set the temperature control using the keypad to POOL or SPA and adjust the set point to the desired temperature setting.
6. If operating difficulties are encountered, contact a qualified service company for assistance.



ATTENTION: Heater installation, checkout, and start-up should now be completed. BE SURE to leave the Owner's Manual with the pool owner.

Figure 18: Heat exchanger header components

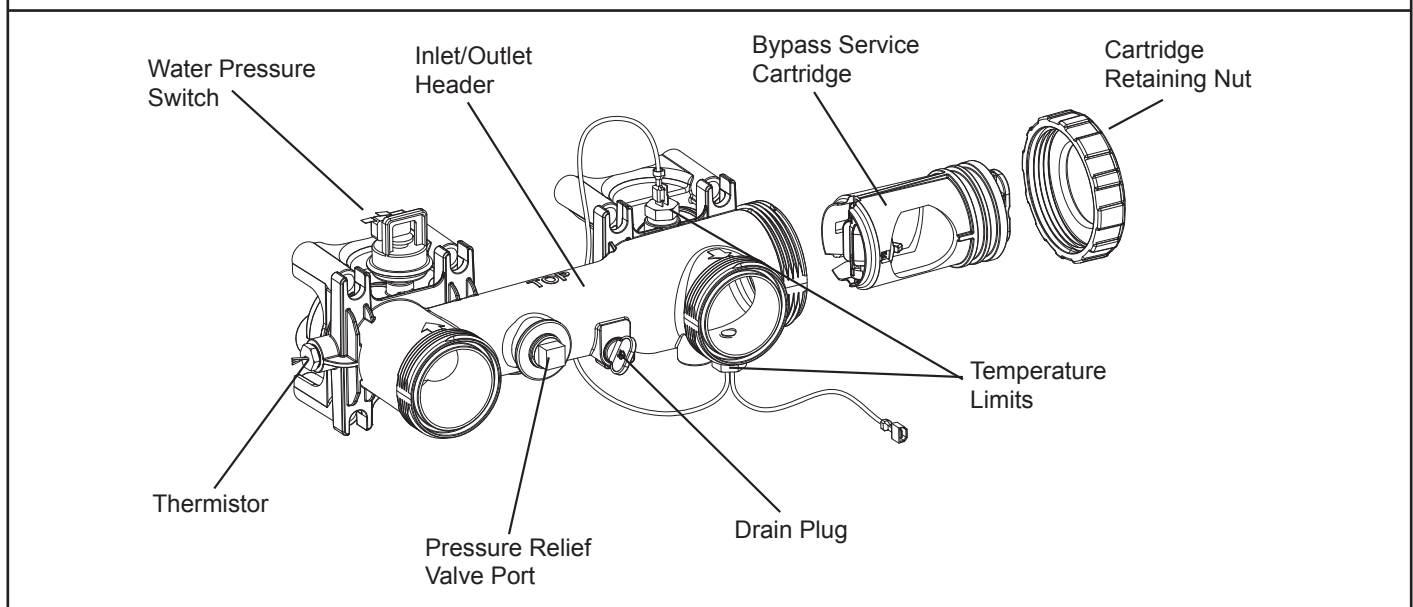

USE ONLY HAYWARD GENUINE REPLACEMENT PARTS

GENERAL:

ATTENTION: Only qualified service technicians, with appropriate test equipment, should be allowed to service the heater. Bear in mind that all of the components that comprise the system have an effect on heater operation. Before proceeding with heater related troubleshooting tips covered in Section V, be certain that the pump is operating correctly, the filters and strainers are not blocked, the valves in the piping are properly positioned, and the time clocks are properly set.

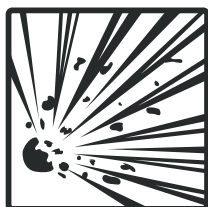

WARNING: EXPLOSION HAZARD Do not attempt to repair any components of this heater. Do not modify the heater in any manner. To do so may result in a malfunction that could result in death, personal injury, or property damage. Check with the consumer to see if any part of the heater has been under water. Replace any part of the control system and any gas control that has been under water.

MAINTENANCE:

The following inspection procedures are recommended to be performed as part of annual heater maintenance and to ensure safe operation.

1. Heat exchanger
2. Main burner flame patterns
3. Main burner orifices
4. Operating controls

HEAT EXCHANGER INSPECTION AND CLEANING:

Remove the Top Jacket and Flue Transition Top Cap (see Figure 2) and inspect the external surfaces of the heat exchanger for soot accumulation. If soot has accumulated, it must be removed by following the recommended procedure:

1. Before beginning, be aware that it is not necessary to remove the water header from the heat exchanger.
2. Turn pump, main gas valve, and heater power OFF.
3. Remove Heat Exchanger Cover (see Figure 2).
4. Disconnect the wires on the exhaust gas temperature limit.
5. Remove Flue Collector Side Panels.
6. Disconnect the wire connecting the heater wire harness to the heat exchanger header. The wire is located on the water pressure switch on the top of the header.
7. Lift Heat Exchanger Assembly out of heater.



WARNING: BURN HAZARD Do not use a wire brush to remove soot from the heat exchanger. This could cause a spark and ignite the gases trapped within the soot.

8. Using a soft-tipped brush such as a paint brush, apply a degreaser to the entire heat exchanger surface (top and bottom). Allow the heat exchanger to sit for a period of time to allow the degreaser to loosen the soot. Wash the heat exchanger using a garden hose ensuring both the top and bottom

USE ONLY HAYWARD GENUINE REPLACEMENT PARTS

surfaces are cleaned. Re-assemble the heater by reversing the disassembly steps. Use care when setting the heat exchanger in place so as not to damage the white sealing gaskets or combustion chamber.

Although the heat exchanger should be cleaned of soot and reinstalled, the fact that sooting occurred should be investigated, as it may indicate other problems such as:

- Insufficient air supply
- High or low gas pressure
- Blockage of burner tubes or orifices
- Blockage of blower inlet
- Low voltage supply causing blower to “spin” slower
- Improper heater location installation
- Incorrect gas supply pipe size
- Excessive water flow through heat exchanger
- LP tank below 30% full

COMBUSTION CHAMBER:

The combustion chamber is a single-piece casting. If damaged, the entire chamber must be replaced.

BURNER INSPECTION AND CLEANING:

With the heater ON, remove the front access panel and make a visual inspection of the main burners through the sight glass (see Figure 15.) The main burner flames should be about $\frac{1}{2}$ " to 2" in height and should not “lift” off the burner ports (see Figure 19).

A normal flame is blue, without yellow tips. Yellow tips or a totally yellow or “lazy” flame may be an indication of a fuel-rich mixture due to restricted air supply. Spider nests in the burner and/or gas orifices may also cause yellow tips.

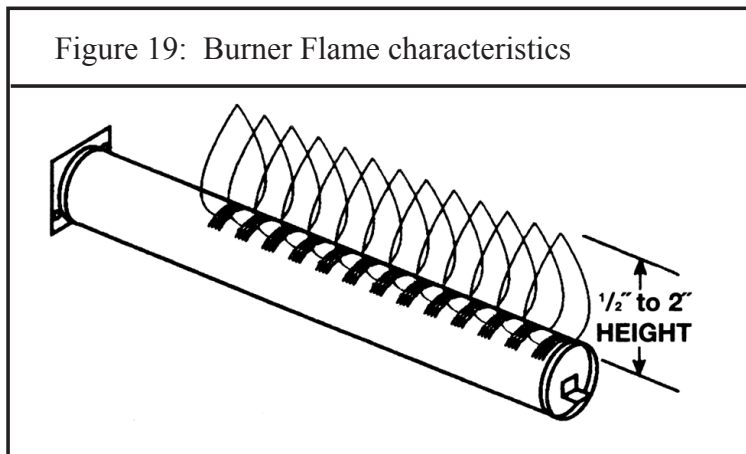

BURNER REMOVAL AND REPLACEMENT:

Refer to Figure 02, Figure 15, and Figure 16 as needed.

1. Turn pump, gas supply, and heater power OFF.
2. Turn gas valve knob OFF.
3. Remove the front access panel.
4. Disconnect the union joint in the gas supply piping outside the heater cabinet.
5. Disconnect the wires from the two terminals on the gas valve.

USE ONLY HAYWARD GENUINE REPLACEMENT PARTS

6. Disconnect the blower wires from the ignition board.
7. Remove the gas manifold assembly. It is attached to the air box using (4) screws.
8. Remove the screws from the igniter access panel and pull it out of the way. Do not disconnect the wires.
9. Remove the air box cover. Do not remove the blower from the air box cover.
10. Remove the (2) screws securing each burner to the combustion chamber front.
11. Pull the burners straight out of the heater.
12. Reverse the above procedure to install the burners.
13. Turn the gas supply ON. Use a soapy water solution to check for leaks. Bubbles forming indicate a leak.

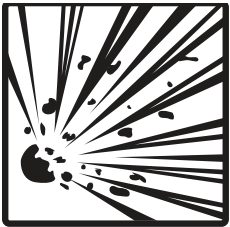

WARNING: EXPLOSION HAZARD The use of an open flame to check for gas leaks could cause an explosion resulting in severe injury and/or death

GAS VALVE REPLACEMENT:

Refer to Figure 02, Figure 15, and Figure 16 as needed.



ATTENTION: Do not attempt to repair the gas valve. If found defective, replace the entire valve. Attempts to repair it will void the warranty.

1. Turn pump, gas supply, and heater power OFF.
2. Disconnect the union joint in the gas supply piping outside the heater cabinet.
3. Remove the front access panel.
4. Disconnect the wires from the two terminals on the gas valve.
5. Remove the gas manifold assembly. It is attached to the air box using (4) screws.
6. Unscrew the gas valve from the gas manifold pipe.
7. Reassemble the gas manifold assembly using the new gas valve. Only use liquid pipe thread sealant on the male threads of the gas manifold pipe. Do not place pipe dope on the first two threads of any joint.
8. Reverse the above procedure to re-install the gas manifold.

IGNITER REPLACEMENT:

Refer to Figure 02 and Figure 15 as needed.

To remove the igniter:

1. Turn pump, gas supply, and heater power OFF.
2. Remove the front access panel. (See Figure 02)
3. Disconnect the igniter wires from the ignition control board.
4. Remove the screw from the igniter access panel. Working from the underside of the panel, press the bushing out of the hole in the sheet metal panel.
5. Slide the igniter wires through the slot on the panel and pull the panel free.
6. Remove the (2) screws that secure the igniter.

USE ONLY HAYWARD GENUINE REPLACEMENT PARTS



HAYWARD Pool Products
A Hayward Industries, Inc. Company

Pomona, CA Clemmons, NC Nashville, TN
Tel: 908-355-7995 www.hayward-pool.com

7. Pull the igniter straight back until it is free of the combustion chamber, then out of the air box.
8. Reverse the above procedure to install the igniter.

FLAME SENSOR REPLACEMENT:

Refer to Figure 02 and Figure 15 as needed.

To remove the flame sensor:

1. Turn pump, gas supply, and heater power OFF.
2. Remove the front access panel.
3. Disconnect the wire from the ignition board.
4. Remove the screws that secure the flame sensor to remove the sensor.
5. Reverse the above procedure to install the flame sensor.

BURNER ORIFICE REPLACEMENT:

Refer to Figure 02 and Figure 15 as needed.

To remove the burner orifices:

1. Turn pump, gas supply, and heater power OFF.
2. Disconnect the union joint in the gas supply piping outside the heater cabinet.
3. Remove the front access panel.
4. Disconnect the wires from the terminals on the gas valve.
5. Remove the gas manifold assembly. It is attached to the air box using (4) screws.
6. Remove the orifices using a 7/16" wrench.
7. After cleaning or replacing orifices re-install into the gas manifold pipe being careful not to cross-thread or over tighten as a leak may result.



ATTENTION: Do not enlarge orifice holes.

GAS CONVERSION:

The factory-installed gas train may be changed from natural gas to propane or from propane to natural gas using the appropriate conversion kits available from the factory. Gas conversions are to be performed only by a qualified service agency. Detailed instructions are included with each kit.

ELECTRICAL WIRING:



ATTENTION: If it is necessary to replace any of the original wiring, it must be replaced with Hayward supplied replacement parts.

IGNITION CONTROL SYSTEM:

The ignition control system in this heater consists of 2 printed circuit boards (the ignition control board and the display board) and a keypad. The locations of these components are shown in Figure 15. The ignition control system functions as the heater's thermostat, safety control system, and controller for the gas combustion system.

USE ONLY HAYWARD GENUINE REPLACEMENT PARTS

To remove/replace the ignition control board:

1. Turn pump, gas supply, and heater power OFF.
2. Remove the front access panel.
3. Disconnect all wires from the printed circuit board.
4. Detach the board from the sheet metal panel by compressing the plastic standoffs.
5. Replace the board, and reverse the above steps to reassemble.

To remove/replace the display board or keypad:

1. Turn pump, gas supply, and heater power OFF.
2. Remove the front access panel.
3. Remove the 4 screws and remove the plastic bezel & keypad assembly from the sheet metal panel on the front of the heater.
4. The display board is attached to the back side of the bezel & keypad assembly.
5. Detach the board from the plastic bezel by removing the small screws and removing the board from the (4) spring clips near the center of the board.
6. Replace the display board or bezel & keypad assembly, and reverse the above steps to reassemble.

BLOWER VACUUM SWITCH:

The blower vacuum switch is a safety device that prevents the ignition sequence from continuing unless the blower is developing sufficient airflow for combustion. Figure 15 shows the location of the blower vacuum switch in the heater cabinet. When the blower achieves sufficient airflow, the negative pressure created in the blower housing closes the contacts on the blower vacuum switch, indicating to the ignition control board that it is safe to continue the ignition sequence. A silicone tube connects the blower vacuum switch with the blower.

To remove the blower vacuum switch:

1. Turn pump, gas supply, and heater power OFF.
2. Remove the front access panel.
3. Remove the wires from the vacuum switch.
4. Pull the tubing from the hose barb on the switch.
5. Remove the (2) screws that secure the pressure switch to the control panel.
6. Reverse the above procedure to install the blower vacuum switch.

HIGH LIMIT SWITCHES:

The high limit is an automatically resetting safety device wired in series with the thermostat and gas valve. See Figure 18. The heater is equipped with two automatic high limits, located on the water header.

If the water temperature exceeds the limit set point, the gas valve will be closed, shutting off gas supply to the burners.

Erratic high limit operation is often an indication of a problem with water flow. Reduced flow may be caused by:

1. Clogged filter or strainer.
2. Excessive flow through the external bypass if one is used.
3. Lime scale accumulation in the heat exchanger.

USE ONLY HAYWARD GENUINE REPLACEMENT PARTS

To replace a high limit switch:

1. Turn pump, gas supply, and heater power OFF.
2. Drain the heat exchanger of all water.
3. Unplug the high limit wires from the wiring harness.
4. Unscrew the high limit switch from the header.
5. Replace the high limit switch. Use new sealant on the high limit switch threads before reinstalling.
6. Reverse the above procedure to install the high limit switch.

EXHAUST GAS TEMPERATURE LIMIT:

The exhaust gas temperature limit monitors the flue gas temperature above the heat exchanger and trips if temperature rises high enough to indicate that the heat exchanger has been damaged and is no longer transferring heat to the pool water effectively. If this limit trips, effort must be made to rectify the situation that has damaged the heat exchanger. This is generally due to low water flow, poor water chemistry, or a combination of these and other factors. Replace the limit as well as the heat exchanger before operating the unit again. Running the unit without replacing the heat exchanger after this limit trips could damage the entire unit and will not be covered by Hayward's warranty.

To replace the exhaust gas temperature limit:

1. Turn pump, gas supply, and heater power OFF.
2. Remove the top jacket, flue transition top cap, and heat exchanger cover (see Figure 02).
3. Unplug the two wires from the exhaust gas temperature limit located in the flue collector panel above the middle of the header.
4. Unscrew the (2) screws securing the limit to the panel and remove the limit and gasket.
5. Place the new limit and gasket in place and reverse the above steps to complete the procedure.

THERMISTOR:

The thermistor monitors the return water temperature. See Figure 18.

To replace the thermistor:

1. Turn pump, gas supply, and heater power OFF.
2. Drain the heat exchanger of all water.
3. Remove the front access panel. (See Figure 02)
4. Unplug the thermistor connector from the ignition control board.
5. From outside the heater, pull the thermistor leads out of the control box and through the hole in the heater chassis.
6. Unscrew the thermistor from the inlet side of the header.
7. Replace the thermistor. Use new sealant on the thermistor threads before re-installing.
8. Reverse steps above to complete the procedure.

WATER PRESSURE SWITCH:

The water pressure switch (Figure 18) is preset at the factory for most typical, deck level installations. When the heater is located above or below the level of the pool or spa, the pressure switch may require adjustment to compensate for the change in static head pressure. If adjustment is needed, the procedure is detailed in Section III, under Water Pressure Switch Test / Adjustment Procedure.

⚠ ATTENTION: Do not operate the pool heater without the function of a properly adjusted pressure switch or flow switch.

To replace the pressure switch:

USE ONLY HAYWARD GENUINE REPLACEMENT PARTS

1. Turn pump, gas supply, and heater power OFF.
2. Remove top jacket and heat exchanger cover.
3. Remove the wires from the pressure switch.
4. Remove switch from header.
5. Replace the pressure switch. Use new sealant on the pressure switch threads before re-installing.
6. Reverse steps above to complete the procedure.

TRANSFORMER:

The transformer converts the field supply voltage to a 24 VAC output for powering the ignition control board, control circuits, and gas valve. See Figure 15 for its location.

To replace the transformer:

1. Turn pump, gas supply, and heater power OFF.
2. Remove the front access panel.
3. Disconnect all wires from the transformer leads.
4. Remove the (2) screws that secure the transformer to the control box.
5. Replace the transformer. Reassembly is the reversal of steps above.

BLOWER:

The blower provides the air that mixes with the gas at the main burners for the combustion process. The blower operates during the pre-purge time (approximately 30 seconds) at the beginning of each ignition cycle, during the entire time the gas valve is open and the burners are firing, and for 30 seconds after the valve gas closes. See Figure 15 and Figure 20.

To replace the blower:

1. Turn pump, gas supply, and heater power OFF.
2. Remove the front access panel.
3. Disconnect the blower from the ignition control board.
4. Disconnect the tubing from the hose barb on the blower housing.
5. Remove the blower from the air box cover (4 screws).
6. Remove the blower air inlet plate from the blower (5 screws).
7. Reverse the above steps to reassemble the blower. Be sure the blower outlet gasket is in place before proceeding.

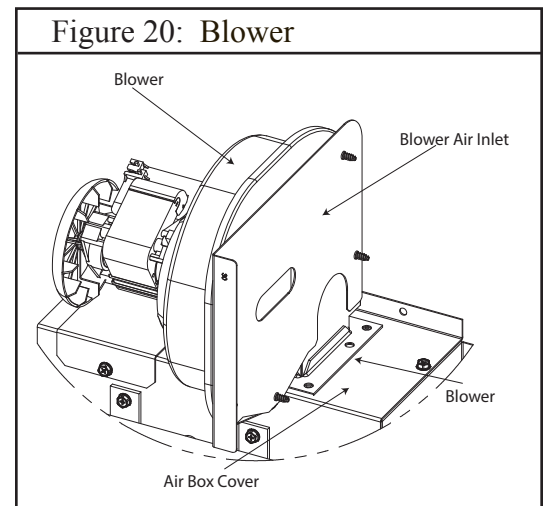

BYPASS SERVICE CARTRIDGE:

The following procedure details how to remove and replace the internal pressure bypass valve in the header.

1. Turn pump, main gas valve, and heater power OFF.
2. Drain heat exchanger according to instructions in Section III of this manual.
3. Remove the cartridge retaining nut from end of header (see Figure 18).
4. Slide out the bypass cartridge from the end of the header (see Figure 18).
5. Check the function of the bypass valve to ensure the valve flaps rotate smoothly on the shaft, and the spring fully closes the valve.
6. Apply silicone o-ring grease (Hayward Jack's 327 Multilube p/n SP032712, or equivalent) on o-ring seals on the bypass cartridge before inserting into the header.
7. Insert bypass cartridge into header with the arrow on the end of the cartridge pointing up.
8. Re-install cartridge retaining nut. Nut should be tightened hand-tight only. DO NOT OVER-TIGHTEN.

USE ONLY HAYWARD GENUINE REPLACEMENT PARTS

GENERAL:

⚠ ATTENTION: These instructions are intended for the use of qualified personnel trained and experienced in the installation and servicing of this type of heating equipment and its related system components. Some states may require installation and service personnel to be licensed. Persons not qualified should not attempt to repair this equipment according to these instructions. These instructions and procedures are not for the use of “do-it-yourself” consumers.



⚠ WARNING: BURN HAZARD The operation of the heater with the pump shut off could cause heater overheating and fire. Never operate heater with the pump shut off.

⚠ ATTENTION: As a preliminary check, make sure that all wire connections are clean and tight and that all wiring conforms to the wiring diagram.

AUTOMATIC RESET TIME:

The heater will automatically reset when an error condition is corrected and resume operation. The heater can be manually reset using the keypad by cycling the MODE button through STANDBY and back to the original operating mode (POOL or SPA).

SUPPLY WIRING:

If the heater is connected to the **line** side of the circuit it will be powered at all times. In this situation, when the pump shuts down the heater will display a fault code of “LO”. If there is a call for heat and the pump then restarts there will be a 2-minute delay for the heater to fire. After the pump has been running for at least 2 minutes there is no delay for heater operation.

Wiring the heater to the load side of the timer or controller will not result in a 2-minute delay if the pump primes quickly enough to activate the heater’s water pressure switch. If the pump is slow to prime the heater may display an “LO” fault code and will take 2 minutes to automatically restart. If the pump has primed, this wait can be avoided by manually clearing the error code via the keypad by cycling the mode through the STANDBY setting and returning to the initial setting (SPA or POOL).

When a heater is wired to the line side of the power circuit (continuous power) the blower will not operate when the pump is cycled via a time clock or other switch method.

INTERNAL WIRING:

If the heater display is blank after the electrical has been installed, refer to Figure 21 and Figure 22 to determine the cause. The ribbon cable between the display board and the ignition control board is keyed and cannot be inserted upside down if it was removed when electrical was done.

FUSE SPECIFICATIONS:

The fuse designations are printed on the ignition control board. See Figure 15 for board locations. Fuses are available as common hardware items or may be purchased from Hayward in a service parts kit. The fuse specifications are:

- F1 fuse (low voltage): 3A blade style fast-acting automotive fuse, type 257

USE ONLY HAYWARD GENUINE REPLACEMENT PARTS

Figure 21: **Error codes**

Code	Description	Information
bD	Internal fault/power-up error	On initial trial for ignition. Automatic reset is immediate once the gas valve relay check results are acceptable.
bD	Gas valve sensed as “ON” error	If valve is open when it should be closed the heater will shut down and go into lockout. Blower will operate until error condition is corrected. Automatic restart 2 minutes after error is corrected.
bD	Gas valve sensed as “OFF” error	If valve is closed but flame is sensed the blower will run for 5 s then start a new ignition sequence. If error occurs 10 times during a call for heat the control will go into lockout. Automatic reset is 60 minutes.
bD	Data retrieval error	If control input data is corrupted the heater will shut down and go into lockout.
HF	Flame present with gas valve “OFF” error	If flame is sensed with the gas valve off the control will go into lockout. The blower will run until error condition is corrected. When corrected, control will run blower for 5 s then automatically restart after 2 minutes.
PF	Electrical supply wiring error	This code will display if 120V polarity is reversed, low voltage is detected, or if the ground path is not sufficient. Reset is immediate after error is corrected.
AO	Blower vacuum switch open error	If the blower proving switch does not close after the blower starts the control will stop the ignition trial and go into lockout. The blower will continue to run. Automatic reset is immediate after the switch closes.
AO	Blower vacuum switch open when expected closed error	If the blower proving switch opens unexpectedly during operation the control will shut down and attempt to re-light. If the switch does not close after the blower starts the control will go into lockout with the blower running. Automatic reset is immediate after error is corrected.
AO	Blower vacuum switch open during post-purge error	If the blower proving switch opens during the post purge cycle (heater is not firing) the control will display the error code. The post-purge cycle will be completed once the blower proving switch closes.
AC	Blower vacuum switch closed when expected open error	If the blower prover switch is closed before blower start-up the control will not start the blower. Automatic reset is immediate when the switch opens.
IO	Igniter open error	If the control is not in lockout and senses that the igniter circuit is open when the blower is running the control will turn off the blower and go into lockout. Automatic restart 2 min after error is corrected.
SF	Thermistor error	An excessive temperature difference between the two thermistors (5 °F or more) or an “out of bounds” condition on both sensors (less than 10°F or greater than 180°F) will result in the error code. Automatic restart is 2 minutes after the error is corrected.

USE ONLY HAYWARD GENUINE REPLACEMENT PARTS

Code	Description	Information
HS	Water Temperature Sensing Error	A) Inlet water temperature sensor is reporting a temperature in excess of 104°F. Normal operation resumes 2 minutes after inlet water temperature sensor reports temperatures of 104°F or less. This error functions in both normal and remote thermostat modes. or B) Inlet water temperature sensor is reporting a temperature change at a rate faster than 6°F in 60 seconds or less while the heater is firing, indicating a potentially damaging low water flow condition. Normal operation resumes when temperatures stabilize. If this condition is detected 3 times in a one hour period, the heater will lock-out until the electrical power is cycled off and back on.
Sb	Keypad button stuck closed error	If one of the keypad buttons is closed (or pressed) for more than 30 s the error code will be displayed but the control will continue to function. The error code will be cleared when the condition is corrected.
IF	Ignition failure error	If the control exceeds the maximum number of ignition retries or recycles the heater will shut down and go into lockout. Automatic reset is 60 minutes.
CE	Communication error	If communication between the ignition board and the display board is not established within 3 s of power-up an error will be displayed. After communication is established, if it is lost for 30 s, the error will be displayed. The error code will be cleared upon a valid data exchange between boards.
LO	Limit string open error	If the limit string opens the heater shuts down and goes into lockout. Automatic restart is 2 minutes after the error condition is corrected and the limit string closes. See the troubleshooting section for more detail.
EE	EEPROM error	An error was detected in the ignition control circuit board.

USE ONLY HAYWARD GENUINE REPLACEMENT PARTS

Code	Fault	Diagnosis Step	Remedy
None	Heater will not power up	1. Ensure field power supply to heater is turned on.	Measure for field supply voltage across primary terminals of transformer.
		2. Check for defective Transformer.	If 120 VAC is present at transformer primary, check secondary for 24 VAC. If not present, replace transformer.
	Low voltage circuit fault.	1. Check for faulty Control Module wiring.	Inspect Control Module wiring. Ensure all plugs are securely fastened to Control Module. If OK, proceed to step 2.
		2. Verify low voltage input to Control Module.	Verify 24VAC across R and C terminals on Control Module. If not OK, replace harness. If OK, proceed to step 3.
		3. Verify that F1 Fuse on Control Board is not open.	Remove F1 fuse from fuseholder. Measure continuity across fuse. If OK, replace Control Module. If fuse is open, proceed to section titled "Open Fuse on ignition board".
	Low voltage fault	1. Check for faulty Transformer wiring.	Inspect Transformer wiring. Ensure insulation on wiring is not worn. If OK, proceed to step 2.
		2. Defective Transformer	Replace Transformer.
	Open Fuse on ignition board	1. Check for faulty Gas Valve wiring.	Inspect Gas Valve wiring. Ensure insulation on wiring is not worn. If OK, proceed to step 2.
		2. Verify that Gas Valve is not defective.	Measure for resistance across Gas Valve terminals and between each terminal and ground. If short exists, replace Gas Valve. If OK, proceed to step 3.
		3. Check for faulty Control Module wiring.	Inspect Control Module wiring. Ensure insulation on wiring is not worn. If OK proceed to step 4.
		4. Control Module is defective.	Replace Control Module.
	bD	Bad Board or Secondary High Voltage Fault	1. Check for defective Harness.
2. Check for defective Transformer.			If 120 VAC is present at transformer primary, check secondary for 24 VAC. If not present, replace transformer.
EE	Bad Board	1. Defective Control Module	Replace Control Module.
CE	Communication Error between Control Module and Display Interface Assembly	1. Disconnect and then reconnect power to heater.	
		2. Check for faulty wiring or connection.	Inspect Display Interface Wiring. Ensure Display Interface Plug is securely attached to Control Module. If OK, proceed to step 3.
		3. Control Module and/or Display Interface Assembly are defective.	Replace Control Module and/or Display Interface Assembly.
PF	Supply power fault	1. Check polarity of electrical outlet powering the heater.	If neutral and line voltage wires are reversed on the electrical outlet, have an electrician remedy this issue. (Swap the line and neutral wires.) If line and neutral wires are correct, proceed to step 2.
		2. Check that the ground wire is connected in the electrical outlet powering the heater.	If ground wire is not connected, have an electrician remedy this issue. If ground wire is connected, proceed to step 3.

USE ONLY HAYWARD GENUINE REPLACEMENT PARTS

40 Figure 22: **TROUBLESHOOTING** (continued)

Code	Fault	Diagnosis Step	Remedy
PF	Supply power fault	3. Check supply voltage.	If supply voltage is below 100 VAC, have an electrician remedy this issue.
IO	Igniter Failure	1. Check for faulty wiring or connection.	Inspect Igniter wiring. Ensure Igniter Plug is securely attached to Control Module. If OK, proceed to step 2.
		2. Igniter is defective	Replace Igniter.
Sb	Keypad Failure	1. Keypad is defective	Replace bezel and keypad assembly.
SF	Temperature sensor input failure	1. Check for faulty wiring or connection.	Inspect sensor wiring. Ensure sensor is plugged into control module. If OK, proceed to step 2.
		2. Sensor is defective	Replace temperature sensor.
HS	Water Temperature Sensing Error	1. Check remote thermostat setting	Verify set point setting of remote thermostat is at or below 104°F. If set point of remote thermostat is OK, or if heater is not configured for remote thermostat, proceed to step 2.
		2. Verify that the water flow is adequate	Verify that water flow to heater is above minimum required (20 GPM). Note that intermittent periods of low water flow will cause this error. If OK, proceed to step 3.
		3. Check inlet water temperature sensor	Compare the heater's temperature reading to the pool water temperature with an accurate thermometer. If significantly different, replace inlet water temperature sensor.
HF	Flame Present with Gas Valve not Energized	1. ICB is defective	Using the sight glass, check to see if the flame is present in the unit. If not, replace ICB. If flame is present, move to next step. Without disconnecting the valve from the wiring harness, use a voltmeter to determine if 24 VAC is present at the gas valve connections. If so, replace ICB. If not, move to step 2.
		2. Gas Valve is defective	Replace Gas Valve

USE ONLY HAYWARD GENUINE REPLACEMENT PARTS

Code	Fault	Diagnosis Step	Remedy
LO	Water pressure switch fault	1. Verify that the pump is running.	This is a normal display when the pump is off. Turn pump on. LO code should clear. If LO does not clear, proceed to step 2.
		2. Verify that water flow is adequate	Verify that water flow rate to heater is above minimum required (20 GPM). If OK, proceed to step 3
		3. Check for faulty wiring or connection.	Inspect water pressure switch wiring. Ensure wire harness terminals are securely fastened to spade terminals on water pressure switch. If OK, proceed to step 4.
		4. Verify state of water pressure switch contacts.	Remove wire leads from water pressure switch and measure continuity across water pressure switch with the pump running. If open, proceed to step 5. If closed, LO code is not caused by water pressure switch fault. Reconnect wire leads to water pressure switch.
		5. Ensure that low pump pressure does not exist.	Clean filter or clear blockages. Check position of valves in plumbing system. If OK proceed to step 6.
		6. Check for correct water pressure switch setting.	Adjust water pressure switch setting as shown in Section III of Installation Manual (only if heater is above or below water level). If LO does not clear, proceed to step 7.
		7. Water pressure switch is defective	Replace water pressure switch.
	Temperature limit switch fault	1. Check for faulty wiring or connection.	Inspect temperature limit switch wiring. Ensure wire harness terminals are securely fastened to spade terminals on temperature limit switches. If OK, proceed to step 2.
		2. Verify state of temperature limits' contacts	Remove wire leads from limit switch and jumper leads. Operate heater. Measure continuity across limit switches. If closed, LO code is not caused by temperature limit switch fault. If open, proceed to step 3. Remove jumper from leads and reconnect leads to temperature limits.
		3. Verify that water flow is adequate	Verify that water flow rate to heater is above the minimum required (20 GPM). If OK, proceed to step 4.
		4. Temperature limit switch is defective.	Replace temperature limit switch.
	Exhaust gas temperature limit fault	1. Check for faulty wiring or connection	Inspect temperature limit switch wiring. Ensure wire harness terminals are securely fastened to spade terminals on temperature limit switch located in the flue collector panel above the center of the header. If OK, proceed to step 2.
		2. Verify state of temperature limit's contacts	Remove wire leads from limit switch and measure continuity across limit switch contacts. If closed, LO code is not caused by exhaust gas temperature limit switch fault. If open, proceed to step 3.
		3. Heat exchanger has been damaged	Heat exchanger has been damaged. This is generally due to low water flow, poor water chemistry, or a combination of these and other factors. Rectify all issues with water flow through the heater and water chemistry and then replace the heat exchanger and exhaust gas temperature limit. Continuing to run the heater after this limit has tripped will cause damage to the entire unit and will not be covered by the warranty.

USE ONLY HAYWARD GENUINE REPLACEMENT PARTS

42 Figure 222: **TROUBLESHOOTING** (continued)

Code	Fault	Diagnosis Step	Remedy
IF	Ignition Failure	1. Ensure gas supply shutoff valves are open.	Ensure that main gas shutoff installed adjacent to heater is open. Ensure that knob on gas valve inside unit is in "ON" position. If OK, proceed to step 2.
		2. Check for low gas supply pressure	Ensure inlet gas supply pressure is between the minimum and maximum values indicated on rating plate. If OK, proceed to step 3.
		3. Check for faulty flame sense wiring or connection.	Inspect flame sense wiring. Ensure wire harness terminals are securely fastened to flame sense and to control module. If OK, proceed to step 4.
		4. Check for faulty gas valve wiring or connection	Inspect gas valve wiring. Ensure wire harness terminals are securely fastened to spade terminals on gas valve. If OK, proceed to step 5.
		5. Check for gas valve failure or gas valve relay failure.	1. Measure voltage across gas valve during trial for ignition. If 24VAC is present and gas valve does not open, gas valve is defective. Replace gas valve.
			2. If 24VAC is not present, gas valve relay on control module is defective. Replace control module.
6. Check for blockages in gas orifices and burners	Inspect gas orifices for blockages which could prevent gas flow. Remove and inspect burners for blockages.		
AC	Blower vacuum switch closed.	1. Check for defective blower on relay or control module.	Disconnect Blower plug from Control Module. With heater off, measure continuity across pins 1 and 2 of receptacle on Control Module. If closed, control module relay is defective. Replace control module. If OK, proceed to step 2.
		2. Vacuum switch is defective.	Replace blower vacuum switch.
AO	Blower vacuum switch open.	1. Check for faulty vacuum switch tubing	Check tubing and replace if necessary. If OK, proceed to step 2.
		2. Check for faulty vacuum switch wiring or connection.	Inspect vacuum switch wiring. Ensure wire harness terminals are securely fastened to spade terminals on vacuum switch. If OK, proceed to step 3.
		3. Check for faulty blower wiring or connection	Inspect blower wiring. Ensure plug on blower is securely fastened to control module. If OK, proceed to step 4.
		4. Check for defective vacuum switch	Disconnect Blower plug from Control Module. Measure resistance across Blower windings. Winding resistance across lead should be in the following range; Black-to-White: 4 to 5 ohms. If measured values vary substantially from these values, Blower is defective. Replace. If OK, proceed to step 5.
		5. Check for defective blower relay.	Disconnect Blower plug from Control Module. Place heater in Pool or Spa Mode. Raise set point temperature to generate call for heat. During pre-purge period, measure for 120VAC across pins 1 and 2. If 120VAC is not present, control module relay is defective. Replace control module. If OK, proceed to step 6
		6. Vacuum switch is defective	Replace blower vacuum switch.
bO	Bypass Operation	1. Check to see if Control Module is in Bypass Operation	This is normal display when heater is being controlled by a remote thermostat. No service is required. If heater is not being controlled by remote thermostat, change setting by using the MODE key to put the heater into STANDBY. Press and hold the DOWN key and then press and hold the MODE key. Hold down both keys for 3 seconds until the indication "bO" is removed from the display.

USE ONLY HAYWARD GENUINE REPLACEMENT PARTS

LIMITED HEATER WARRANTY:

TERMS AND COVERAGE:

We warrant our pool heater to be free from defects in workmanship and materials under normal use and service. Pursuant to this warranty and subject to the Conditions and Exceptions indicated below:

1. We will replace (cost of freight, installation, cost of fuel, and service labor at user's expense) with the prevailing comparable model, or, at our option, repair any pool/spa heater that leaks under normal use and service within one year from the date of original installation for all users.
2. In addition, we will replace (cost of freight, installation, cost of fuel, and service labor at user's expense) or, at our option, repair any part or parts of the pool/spa heater which malfunctions under normal use and service within one year from the date of original installation for all users.

LIMITATION ON IMPLIED WARRANTIES:

WE ARE NOT LIABLE FOR ANY CONSEQUENTIAL DAMAGES FOR BREACH OF ANY WRITTEN OR IMPLIED WARRANTY OF THIS PRODUCT. Implied warranties, including the WARRANTY of MERCHANTABILITY and all other implied warranties that may arise from course of dealing or usage of trade imposed on the sale of this heater under laws of the state are limited in duration to the term of one (1) year for all products when products are NOT installed and serviced by a licensed and qualified pool equipment professional with all sufficient experience in pool equipment installation and maintenance and adhering to the requirements of the jurisdiction where the product is installed.

Warranty extends in duration to the term of (2) years for all non-ASME certified products ONLY when products are installed and serviced by a licensed and qualified pool equipment professional with sufficient experience in pool equipment installation and maintenance and adhering to the requirements of the jurisdiction where the product is installed. There are no warranties which extend beyond the description on the face hereof. We shall not in any event be held liable for any special, indirect or consequential damages.

EXPENSE OF DELIVERY AND INSTALLATION:

Each pool heater or replacement part to be furnished under this warranty shall be furnished at our nearest distribution center. We shall not pay, nor be responsible for shipping or delivery charges to the place of installation, nor for labor charges or other costs of removal or installation. Every defective heater or part replaced under this warranty shall become our property, and as such, must be returned to our distribution center with transportation charges paid by the user. Any replacement pool heater furnished under this warranty shall remain in warranty only for the unexpired portion of this warranty.

CONDITIONS AND EXCEPTIONS:

This warranty applies only to the pool/spa at its original place of installation and only for the original owner. It does not apply if the pool heater is installed in violation of any applicable code or ordinance, or is not installed, operated and maintained in accordance with our instructions, or is misused, damaged by accident, weather, act of God, freezing, water void and/or excess pressure, altered or disconnected. It does not apply with respect to:

1. A heater not equipped with Certified C.S.A. limit controls or equivalent pressure relief valve.
2. A heater operated with settings in excess of, and/or with fuel not conforming to those shown on rating plate;
3. A heater on which the serial numbers have been altered, defaced, or removed.
4. Leaks arising from defective installation;
5. Production of noise, odors, or discolored (rusty, etc.) water;

USE ONLY HAYWARD GENUINE REPLACEMENT PARTS

6. Leakage substantially contributed to by sediment, lime precipitate and/or higher than normal dissolved solids (pH above 7.8) in the tank, copper tubes, or water ways;
7. Leakage caused substantially contributed to by corrosive elements in the atmosphere (such as the storage of chlorine or other chemicals);
8. Leakage caused substantially or contributed to by corrosive pool water in an acid condition (pH below 7.2);
9. Damage caused substantially or contributed to by an external source of energy;
10. A pool/spa heater is a water containing device. Leakage of water from this device can be expected at some time due to malfunction or the limitations of the service life of various components. Do not install this product where such leakage can cause damage. **MANUFACTURER IS NOT RESPONSIBLE OR LIABLE FOR ANY COSTS INCURRED BY SUCH DAMAGE.**

IN NO CASE ARE WE TO BE HELD LIABLE FOR DAMAGE TO SURROUNDING AREA OR PROPERTY CAUSED BY LEAKAGE OR MALFUNCTION.

HOW TO CLAIM UNDER THIS WARRANTY:

The original owner, upon discovering the defect, must present the attached completed warranty claim card with proof of purchase either to the dealer or notify Hayward in writing as described on the warranty card.

Upon receipt of such notification we shall decide whether to repair such parts or replace any pool heater, reserving at all times the right to inspect in order to verify any claimed defect. We also reserve the right to have our representatives make any inspections, repairs, or to furnish replacements. This warranty is intended as a legally binding obligation of Hayward Industries, Inc., enforceable in the courts. This warranty may give you specific legal rights which may vary from state to state.

LIMITATION ON LIABILITY:

All intended representations have been expressly set forth in this document. This warranty may not be extended by oral or any other additional representations, written sales information, drawings, or other malfunction, is strictly limited to repair or replacement of the defective heater or part, as provided herein and Hayward Industries, Inc. is not responsible hereunder for incidental or consequential or incidental costs or damages. The company neither assumes, nor authorizes any person or firm to assume for us, any further liability or obligation in connection with the sale, installation, use, maintenance, or existence of the heater. **SAFETY WARNING:** Pool heaters are heat producing appliances and to avoid damage or injury in the event of possible overheating of the outer jacket (1) no materials should be stored against the jacket and (2) care should be taken to avoid unnecessary contact (especially by children) with the jacket. When lighting a gas heater, the lighting instructions must be followed exactly to prevent "flashback" of excess gas in the heater. Electronic ignition heaters and electric heaters must have the power shut off when making adjustments to, servicing, or coming into contact with the heater. **UNDER NO CIRCUMSTANCES SHOULD FLAMMABLE MATERIALS, SUCH AS GASOLINE OR PAINT THINNERS, BE USED OR STORED IN THE VICINITY OF THE HEATER OR IN ANY LOCATION FROM WHICH FUMES COULD REACH THE HEATER.** For your comfort, enjoyment and safety, please read the enclosed operating instructions carefully.

USE ONLY HAYWARD GENUINE REPLACEMENT PARTS

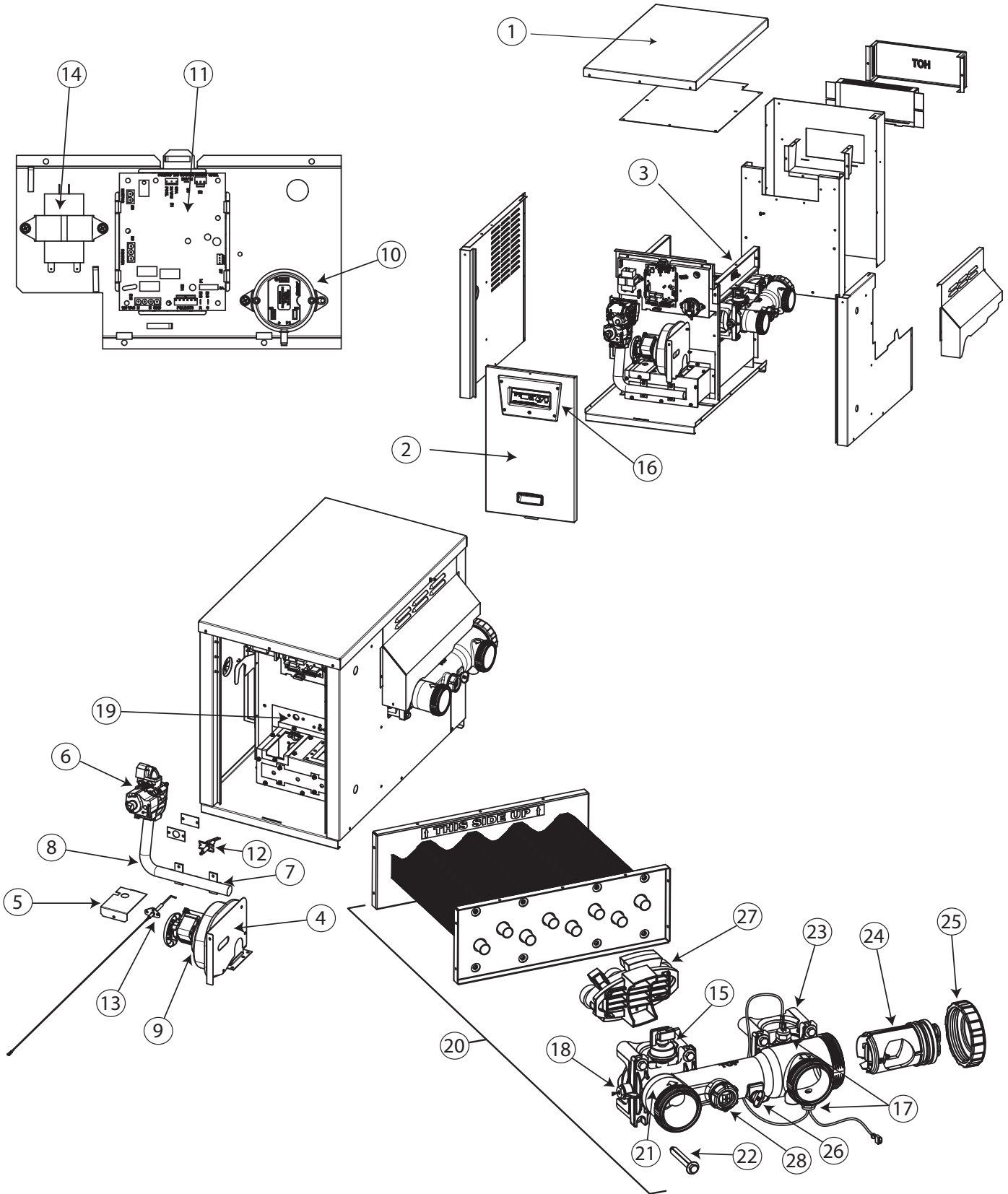

USE ONLY HAYWARD GENUINE REPLACEMENT PARTS

46 SERVICE PARTS

ITEM	PART NO.	DESCRIPTION
1	IDXLJKT1135	JACKET TOP - H135ID/ABG135
2	IDXLFAD1135P	FRONT ACCESS DOOR ASSY - H135ID, PLATINUM -NO CONTROLS
	IDXLFAD1135B	FRONT ACCESS DOOR ASSY - ABG135, BLACK - NO CONTROLS
3	FDXLFCS1931	FLUE COLLECTOR SIDE PANEL W/O TEMPERATURE LIMIT
4	IDXLBBN1135	BLOWER INLET BAFFLE - 135K BTU HEATER
5	FDXLIAC1930	IGNITER ACCESS COVER
6	FDXLGSV0001	GAS VALVE, NATURAL
	FDXLGSV0002	GAS VALVE, PROPANE
7	IDXLBON1135	BURNER ORIFICE KIT, NATURAL - 135K BTU HEATER
	IDXLBOP1135	BURNER ORIFICE KIT, PROPANE - 135K BTU HEATER
8	FDXLMAN1150	GAS MANIFOLD - 135K / 150K BTU HEATER
	FDXLGCK1135NP	CONVERSION KIT, NA TO LP, QUICK-CHANGE - 135K BTU HEATER
	FDXLGCK1135PN	CONVERSION KIT, LP TO NA, QUICK-CHANGE - 135K BTU HEATER
9	FDXLBWR1930	COMBUSTION BLOWER
10	FDXLBVS1930	BLOWER VACUUM SWITCH
11	FDXLICB1930	INTEGRATED CONTROL BOARD
12	FDXLIGN1930	IGNITOR
13	IDXLFLS1930	FLAME SENSOR
14	IDXLTRF1135	TRANSFORMER - 135K BTU HEATER
15	FDXLWPS1930	WATER PRESSURE SWITCH
16	IDXLBKP1135	BEZEL & KEYPAD ASSEMBLY
17	FDXLHLI1930	HIGH LIMIT KIT
18	FDXLTER1930	THERMISTOR
19	FDXLGSK1934	GASKET, CC FRONT/AIR BOX - ALL MODELS
20	FDXLHXA1150	HEAT EXCHANGER ASSY - 135K BTU HEATER
21	FDXLFHD1930	INLET/OUTLET HEADER ONLY
	FDXLFHA1930	INLET/OUTLET HEADER ASSY
22	FDXLHDW1930	HEADER HARDWARE KIT
23	FDXLHMB1930	HEADER MOUNTING BASE KIT
24	FDXLBKP1930	BYPASS CARTRIDGE KIT
25	FDXLCRN1930	HEADER CARTRIDGE RETAINING NUT
26	SPX4000FG	DRAIN PLUG WITH GASKET
27	FDXLPRM1930	RETURN MANIFOLD REPLACEMENT KIT
28	CHXPLG1930	3/4" BRASS PLUG
NOT SHOWN:		
	CHXRLV1930	PRESSURE RELIEF VALVE
	IDXLGSK1135	GASKET KIT - 135K BTU HEATER
INCLUDES:		
		GASKET, FLUE COLLECTOR SIDE
		GASKET, BLOWER MOUNTING
		GASKET, IGNITER COVER
		GASKET, COVER/AIR BOX FRONT
		GASKET, MANIFOLD/AIR BOX
	FDXLGSK1933	INSULATION, RETURN SIDE TUBE SHEET
	FDXLBRN1931	BURNER (QTY 1)
	FDXLFOR1930	HEADER O-RING KIT

USE ONLY HAYWARD GENUINE REPLACEMENT PARTS

ITEM	PART NO.	DESCRIPTION
	FDXLEGL1930	EXHAUST GAS TEMPERATURE LIMIT (ONE-USE)
	IDXLWHA1135	WIRING HARNESS KIT, COMPLETE
	FDXLFSKC30	FUSE KIT, 3.0A, FOR INTEGRATED CONTROL BOARD (QTY 10)
	IDXLUKT1135	UNION KIT (INCLUDES FITTINGS, UNION NUTS, GASKETS)
	SP1493	COUPLING FOR FLEXIBLE HOSE

USE ONLY HAYWARD GENUINE REPLACEMENT PARTS

UNIT RATED CAPACITY

Model	Natural Gas	Propane Gas
H135ID, ABG135	135,000 Btu/hr	135,000 Btu/hr

GAS PRESSURE

Fuel	Natural Gas	Propane Gas
Manifold	1.8" - 2.0" w.c.	6.8" - 7.0" w.c.
Inlet, Minimum	4.5" w.c.	10.0" w.c.
Inlet Maximum	10.5" w.c.	13.0" w.c.

ORIFICE SIZES

Models	Natural Gas	Propane Gas
H135ID, ABG135	0.143"	2.10mm

WATER FLOW REQUIREMENTS

Model	Minimum	Maximum
H135ID, ABG135	20	125

Hayward Pool Products, Inc.
620 Division St.
Elizabeth, NJ 07207

Hayward Pool Products, Inc.
2875 Pomona Boulevard
Pomona, CA 91768

Hayward Pool Products, Inc.
2880 Plymouth Drive
Oakville, Ontario L6H 5R4

© 2017 Hayward Industries, Inc. Printed in U.S.A.

USE ONLY HAYWARD GENUINE REPLACEMENT PARTS

USE ONLY HAYWARD GENUINE REPLACEMENT PARTS