



## CXi™ Pool Heater Service Manual

Models: 500, 650, 750



MENU/EXIT



ENTER/RESET



OFF/ON



UP



DOWN



PREV



NEXT



### **WARNING**

This manual must only be used by a qualified heating installer / service technician. Read all instructions, including this manual and the Installation and Operation Manual, before installing. Perform steps in the order given. Failure to comply could result in severe personal injury, death, or substantial property damage.

Save this manual for future reference.

# Contents

<b>CONTENTS</b> .....	2	<b>2. MAINTENANCE</b>	
Hazard Definitions.....	2	Maintenance and Annual Startup.....	17-24
<b>PLEASE READ BEFORE PROCEEDING</b> .....	3	<b>3. TROUBLESHOOTING</b>	
Handling Ceramic Fiber Materials.....	3	Before Troubleshooting.....	25
When servicing appliance.....	3	Check Control Module Fuses .....	25
Appliance operation.....	3	Table 3A - Troubleshooting Chart - No Display.....	26
Appliance water.....	3	Checking Temperature Sensors .....	27
WHAT IS IN THIS MANUAL.....	4	Table 3C - Troubleshooting Chart - Noisy System.....	28
<b>1. SERVICE</b>		Table 3D - Troubleshooting Chart - Fault Messages..	29-35
The CXi™ Display.....	5	Revision Notes.....	Back Cover
Control Inputs .....	6		
Control Outputs.....	7		
General Operation .....	8		
Sequence of Operation .....	9		
Display Panel Menu Access .....	10		
Display Panel Parameter Access.....	11		
Parameter Table.....	12		
Viewable and Changeable Control Parameters.....	13-16		

## Hazard definitions

The following defined terms are used throughout this manual to bring attention to the presence of hazards of various risk levels or to important information concerning the life of the product.

 **DANGER** DANGER indicates an imminently hazardous situation which, if not avoided, will result in death or serious injury.

 **WARNING** WARNING indicates a potentially hazardous situation which, if not avoided, could result in death or serious injury.

 **CAUTION** CAUTION indicates a potentially hazardous situation which, if not avoided, may result in minor or moderate injury.

 **CAUTION** CAUTION used without the safety alert symbol indicates a potentially hazardous situation which, if not avoided, may result in property damage.

 **NOTICE** NOTICE indicates special instructions on installation, operation, or maintenance that are important but not related to personal injury or property damage.

## Please read before proceeding

### ⚠ WARNING

**Installer** – Read all instructions, including this manual and the Installation and Operation Manual, before installing. Perform steps in the order given.

**User** – This manual is for use only by a qualified heating installer/service technician. Refer to the User's Information Manual for your reference.

Have this appliance serviced/inspected by a qualified service technician at least annually.

Failure to comply with the above could result in severe personal injury, death or substantial property damage.

### NOTICE

When calling or writing about the appliance – Please have the appliance model and serial number from the appliance's rating plate.

Consider piping and installation when determining appliance location (see the Installation and Operation Manual).

Any claims for damage or shortage in shipment must be filed immediately against the transportation company by the consignee.

### When servicing appliance –

- To avoid electric shock, disconnect electrical supply before performing maintenance.
- To avoid severe burns, allow appliance to cool before performing maintenance.

### Appliance operation –

- Do not block flow of combustion or ventilation air to the appliance.
- Should overheating occur or gas supply fail to shut off, do not turn off or disconnect electrical supply to circulator. Instead, shut off the gas supply at a location external to the appliance.
- Do not use this appliance if any part has been under water. The possible damage to a flooded appliance can be extensive and present numerous safety hazards. Any appliance that has been under water must be replaced.

### Appliance water –

- Do not use petroleum-based cleaning or sealing compounds in the appliance system. Gaskets and seals in the system may be damaged. This can result in substantial property damage.
- Do not use “homemade cures” or “appliance patent medicines”. Serious damage to the appliance, personnel, and/or property may result.

## Handling ceramic fiber materials

### REMOVAL OF COMBUSTION CHAMBER LINING

### ⚠ WARNING

The combustion chamber insulation in this appliance contains ceramic fiber material. Ceramic fibers can be converted to cristobalite in very high temperature applications. The International Agency for Research on Cancer (IARC) has concluded, “Crystalline silica in the form of quartz or cristobalite from occupational sources is carcinogenic to humans (Group 1).” Normal operating temperatures in this appliance are below the level to convert ceramic fibers to cristobalite. Abnormal operating conditions would have to be created to convert the ceramic fibers in this appliance to cristobalite.

The ceramic fiber material used in this appliance is an irritant; when handling or replacing the ceramic materials it is advisable that the installer follow these safety guidelines.

- Avoid breathing dust and contact with skin and eyes.

- Use NIOSH certified dust respirator (N95). This type of respirator is based on the OSHA requirements for cristobalite at the time this document was written. Other types of respirators may be needed depending on the job site conditions. Current NIOSH recommendations can be found on the NIOSH website at <http://www.cdc.gov/niosh/homepage.html>. NIOSH approved respirators, manufacturers, and phone numbers are also listed on this website.
- Wear long-sleeved, loose fitting clothing, gloves, and eye protection.
  - Apply enough water to the combustion chamber lining to prevent airborne dust.
  - Remove the combustion chamber lining from the appliance and place it in a plastic bag for disposal.
  - Wash potentially contaminated clothes separately from other clothing. Rinse clothes washer thoroughly.

### NIOSH stated First Aid.

- Eye: Irrigate immediately.
- Breathing: Fresh air.

## What is in this manual?

### Service

#### The CXi™ display

- Display panel readout, buttons and their functions

#### Control module inputs

- Control module inputs and options

#### Control module outputs

- Control module outputs and options

### General

- How the appliance operates
- How the control module operates
- Access modes -- user and installer
- Sequence of operation -- Pool Heating

#### Control panel menu access

- Accessing programming mode and locating menus  
(See separate guides covering the ModBus and PC interfaces)

#### Control panel parameter access

- Accessing and changing parameters from the display panel

#### Quick start information -- parameter table

- An index of available adjustments and readouts, where to access them and where to find detailed information.

### CXi™ operation

- A: General
- B: Temperature Settings
- C: Data Logging
- D: Functions
- E: Anti-cycling
- F: Control Modes
- G: Cascade
- H: Pumps
- I: Service Notification

### Maintenance

- Service and maintenance schedules
- Address reported problems
- Inspect appliance area and appliance interior
- Check all piping for leaks
- Flue vent system and air piping
- Combustion air filter
- Check water system
- Check relief valve
- Check igniter
- Check all appliance wiring
- Flame inspection
- Check flue gas passageways
- Inspect and clean burner
- Checking combustion air pressure
- Checking manifold gas pressure
- Cleaning heat exchanger
- Review with owner

### Troubleshooting

- Troubleshooting table - No display
- Checking temperature sensors
- Troubleshooting table - Noisy system
- Troubleshooting table - Fault messages displayed on Operator Interface

# 1 Service

## The CXi™ display

- Hold 5 seconds to enter code Input Mode (Menu Mode)
- Press to move up one level in Menu Mode or to exit Menu Mode

- Press to turn heater off or back on
- Press to select a menu item
- Press after parameter programming to store parameter data
- Press to exit Service Mode

MENU/EXIT

DISPLAY SCREEN

ENTER/RESET

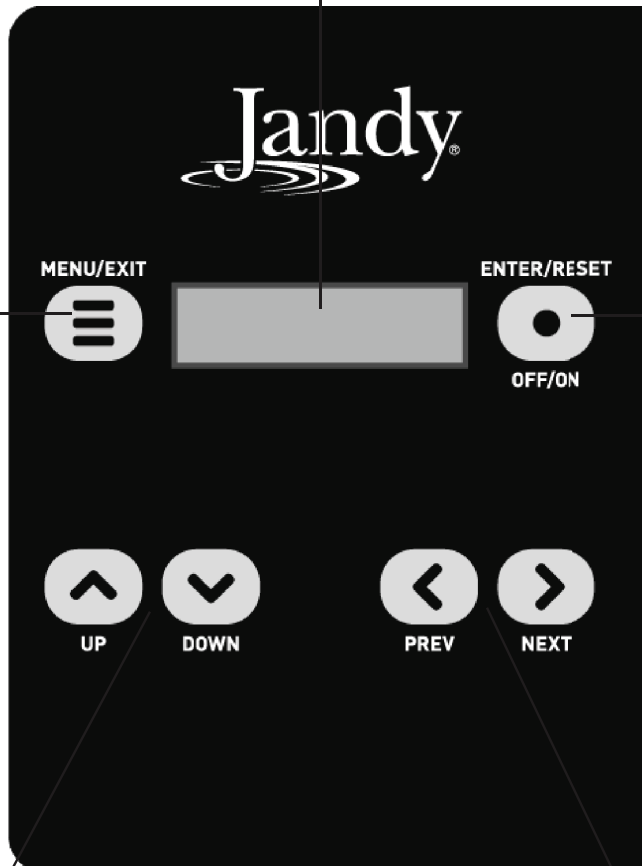
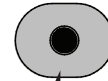

UP

DOWN

PREVIOUS

NEXT

- Press to change boiler water temperature and/or tank water temperature set point during normal operation
- Press to change displayed data values in Menu Mode
- Press to navigate through menu listing in Menu Mode

- Press to toggle display during normal operation to show outlet and return temperatures, fan speed, flame signal, etc.
- Press to toggle between digits when entering access code or between hour, minutes, etc., when entering date and time
- Press and hold both to enter Service Mode

# 1 Service

## Control inputs

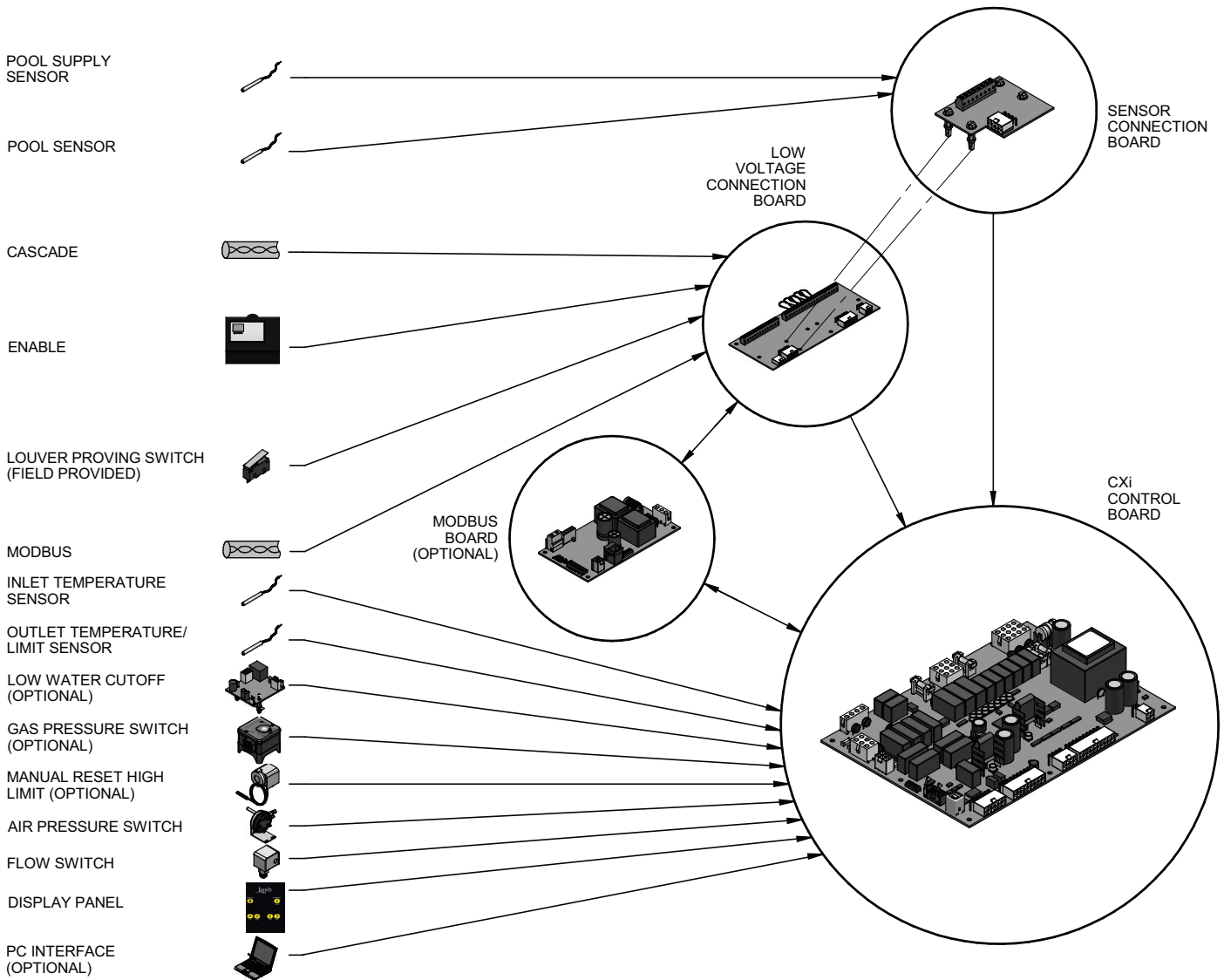

# 1 Service *(continued)*

## Control outputs

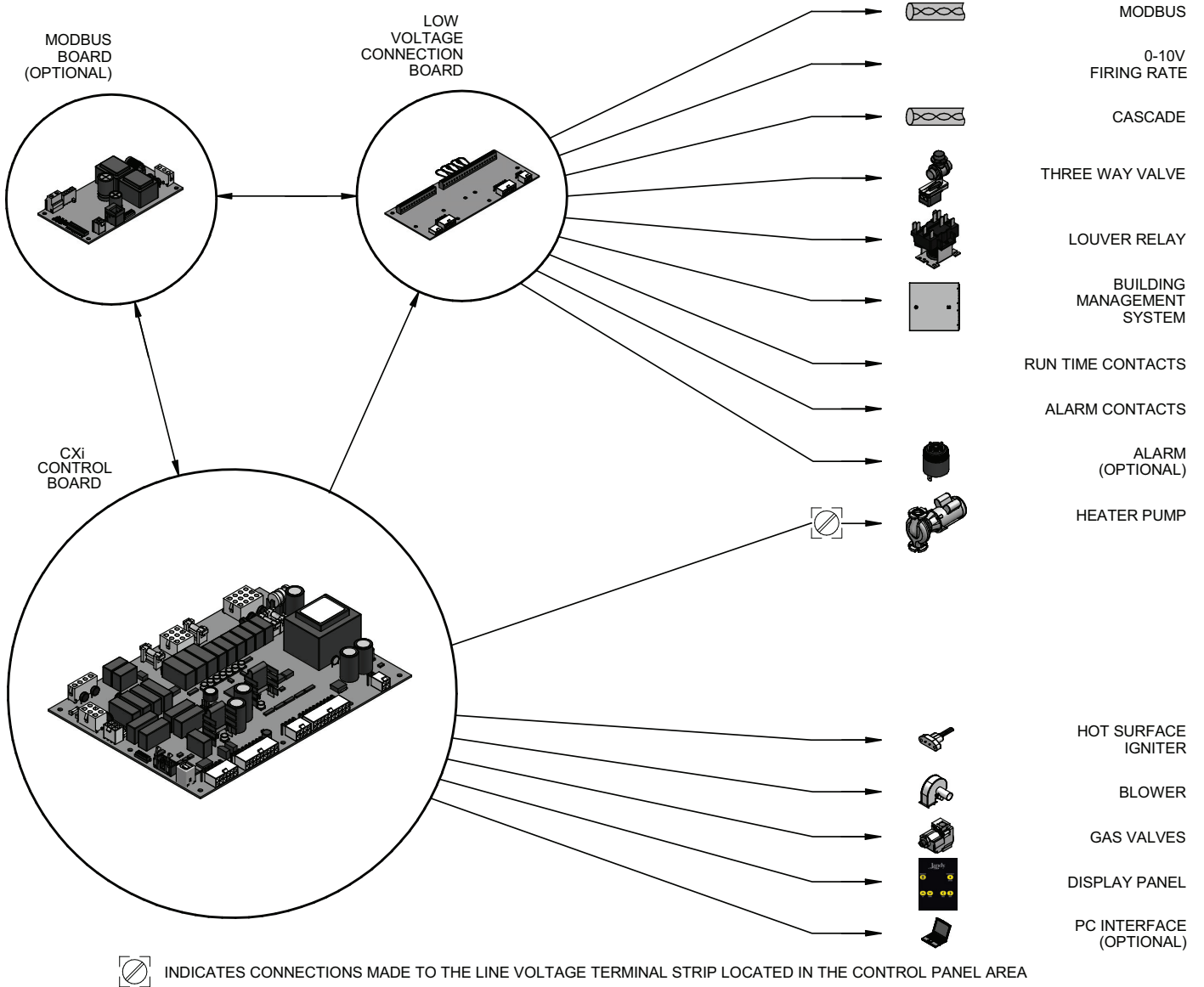

# 1 Service

## General Operation

### How the appliance operates

The CXi™ uses a finned copper tube heat exchanger to transfer heat from the flue products to the water. An electronic control module monitors various inputs to initiate a call for heat. The blower provides both primary and secondary air to the burner and forces the flue products out of the combustion chamber and into the vent system. The control module regulates the blower speed and the firing rate of the appliance.

### How the control module operates

The CXi™ control module receives input from appliance sensors. The control module activates and controls the blower and gas valves to regulate heat input and switches the heater pump on and off as needed. The user/installer programs the module to meet system needs by adjusting control parameters. These parameters set operating temperatures and heater operating modes. Appliance operation is based on heater outlet water temperature, pool supply temperature and pool return temperature.

### Sequence of operation

Table 1A shows control module normal sequences of operation for pool heater operation.

### Access modes

#### User

The user can adjust pool set point by entering the USER code (0704). The user can also change temperature units and time and date. In user mode, the following parameters can be viewed but not changed: Heater model number; software version; total operating hours, and total cycles.

#### Installer

Most parameters are available only to the installer, accessible only by entering the installer access code (5309).

### Saving parameters

#### To save parameters and exit programming:

Press the ENTER/RESET button, then the MENU/EXIT button 3 times.

#### To keep parameter settings only for a current operating cycle:

Press the MENU/EXIT button 3 times after making all desired parameter changes.

#### To enter a parameter and continue programming:

Press the MENU/EXIT button 1 time to return to the parameter listings; press again to return to the menu listings. Remember to press the ENTER/RESET button when finished programming in order to save the changes made.



# 1 Service *(continued)*

## Sequence of operation













**Table 1A**\_Sequence of Operation - Pool Heating

OPERATION	DISPLAY
1. The manual reset high limit (optional) must be closed before any action will take place.	HTR: Standby OUT: 123.8F (129)
2. Upon a call for heat the control turns on the unit pump. The flow switch and low water cutoff (if equipped) must close.	HTR: Standby OUT: 123.8F (129)
3. <ul style="list-style-type: none"> <li>• The gas pressure switch(es) (if equipped) must close.</li> <li>• The louver proving input must close.</li> <li>• If the air pressure switch is open, the prepurge cycle then begins by starting the combustion blower. Once started, the air pressure switch must close.</li> </ul>	HTR: Standby OUT: 123.8F (129)
4. After prepurge, the blower slows down and the hot surface igniter (HSI) is energized.	HTR: PREPURGE OUT: 123.9F (129)
5. Once the HSI is hot, the trial for ignition begins with the opening of the gas valve.	HTR: IGNITION OUT: 123.9F (129)
6. If the CXi™ control does not sense flame, then it will lock out.	HTR: POSTPURGE, PREPURGE OUT: 123.9F (129)
7. If the CXi™ control senses flame, it will fire the burner to maintain the set point. The stages will fire as required to hold the actual temperature at the set point.	HTR: RUN STG: 1 OUT: 124.8F (129)
8. Once the call for heat is satisfied, the control will turn off the burners. The blower will remain on for the postpurge cycle. The unit pump will continue to run for its pump delay time, then turn off.	HTR: POSTPURGE OUT: 127.4F (129)
9. Unit pump off.	HTR: Standby OUT: 122.9F (129)

# 1 Service

## Display panel menu access











Table 1B\_Use this procedure to access menus from the display panel

BUTTON	OPERATION	DISPLAY	COMMENTS
	ENTER/RES Press 1 time in normal operation	HTR: OFF OUT: 123.0F	Heater turns off (this ensures uninterrupted programming)
	MENU/EXIT Hold for 5 seconds -- display will change	Enter Menu Code: 000 <u>0</u> ← flashing	Digit shown underlined at left will flash
	UP Press 9 times to change last digit in readout to "9"	Enter Menu Code: 000 <u>9</u>	Digit shown underlined at left will flash
	PREVIOUS Press 2 times to move to the second digit	Enter Menu Code: 0 <u>0</u> 9	Digit shown underlined at left will flash
	UP Press 3 times to change second digit in readout to "3"	Enter Menu Code: 0 <u>3</u> 9	Digit shown underlined at left will flash
	PREVIOUS Press 1 time to change to the first digit	Enter Menu Code: <u>0</u> 39	Digit shown underlined at left will flash
	UP Press 5 times to change first digit in readout to "5"	Enter Menu Code: <u>5</u> 39	Digit shown underlined at left will flash
<p>If you enter a digit incorrectly, you can move to the digit by using the NEXT and PREVIOUS buttons as needed until the digit you want is flashing. Then use UP and/or DOWN buttons to change the value.</p>			
	ENTER/RES Press to enter the code	Enter Menu Code: INSTALLER CODE	The words, "INSTALLER CODE" will flash while displayed
	After 2 seconds, display shows menus (press ENTER/RESET to select a menu)	>A General B Temp Settings	The caret symbol, ">" highlights the selectable line
<p>If the code is entered incorrectly, the display will return to its previous mode. You will have to start over at step 1 to enter the code.</p>			
	DOWN Press 1 time to highlight second listing	A General >B Temp Settings	The caret symbol, ">" highlights the selectable line
	DOWN Press 1 time to toggle menu listing	>C Data Logging D Functions	The menu toggles to the next two menu options
	DOWN Press 2 times to toggle menu listing	>E Anti-cycling F Control Modes	The menu toggles to the next two menu options
	DOWN Press 2 times to toggle menu listing	>G Cascade	The menu toggles to the next menu option
<p>To select a highlighted menu, press the ENTER/RESET button one time. The display will change to the first parameter under that menu, with the first characters flashing.</p>			

# 1 Service *(continued)*

## Display panel parameter access

**Table 1C\_** This is a typical example of accessing a parameter, shown for parameter H1, PH pump delay

BUTTON	OPERATION	DISPLAY	COMMENTS	
<i>This example shows how to access parameter H1 pump delay. The first display shown is at the beginning of the menu listings, after entering the installer access code.</i>				
	-	Beginning of menu listings.	>A General B Temp Settings	The caret symbol, ">" highlights the selectable line
	DOWN	Press 1 time to highlight second listing	A General >B Temp Settings	The caret symbol, ">" highlights the selectable line
	DOWN	Press 1 time to toggle menu listing	>C Data Logging D Functions	The menu toggles to the next two menu options
	DOWN	Press 2 times to toggle menu listing	>E Anti-Cycling F Control Modes	The menu toggles to the next two menu options
	DOWN	Press 2 times to toggle menu listing	>G Cascade	The menu toggles to the next two menu options
	DOWN	Press 1 time to toggle menu listing	>H Circ. Pump I Service Noti.	The caret symbol, ">" highlights the selectable line
	ENTER/RES	Press 1 time to list parameters	H1 PH Pump Dely	H1 will flash
	ENTER/RES	Press 1 time to select parameter	H1 PH Pump Dely 30 Seconds	H1 will stop flashing; parameter value will appear
	UP (or DOWN)	Press to increase (or decrease) value	H1 PH Pump Dely 40 Seconds <sup>P</sup>	Parameter will increase or decrease, depending on button pressed
	ENTER/RES	Press 1 time to save (or press MENU/EXIT to continue)	H1 PH Pump Dely	H1 will flash
	MENU/EXIT	Press 1 time to return to the main menu	> A General B Temp Settings	
	MENU/EXIT	Press 1 time to return to normal operation	HTR:Pre-Purge OUT:123.7°F	This display example assumes a call for space heating is present

# 1 Service

## Parameter table

Table 1D\_This table lists CXi™ control module parameters and where to access them

	Menu	Sub Item	Description	See Page	User Access		Installer Access	
					Display	Modify	Display	Modify
<b>GENERAL</b>	<b>A</b>	1	User Code	13	Yes	Yes	Yes	Yes
		2	Date and Time	13	Yes	Yes	Yes	Yes
		3	Software Version	13	Yes	No	Yes	Yes
		4	Temperature Units	13	Yes	Yes	Yes	Yes
<b>TEMPERATURE SETTINGS</b>	<b>B</b>	1	Pool Setpoint	13	Yes	Yes	Yes	Yes
		2	PH Min Setpoint	13	No	No	Yes	Yes
		3	PH Max Setpoint	13	No	No	Yes	Yes
		4	PH Offset	13	No	No	Yes	Yes
		5	PH Differential	13	No	No	Yes	Yes
		6	Manual Reset High Limit	13	Yes	Yes	Yes	Yes
		7	PH Supply Hi Limit	13	No	No	Yes	Yes
<b>DATA LOGGING</b>	<b>C</b>	1	Hours Run PH	13	No	No	Yes	Yes
		2	Ignition Attempts	14	No	No	Yes	Yes
		3	Last 10 Lockouts	14	No	No	Yes	Yes
<b>FUNCTIONS</b>	<b>D</b>	1	Clear Error Log	14	No	No	Yes	Yes
		2	Service Delay	14	No	No	Yes	Yes
		3	Display Time	14	No	No	Yes	Yes
		4	Bypass Time	14	No	No	Yes	Yes
		5	Freeze Pump	14	No	No	Yes	Yes
		6	Freeze Burn	14	No	No	Yes	Yes
		7	Freeze Diff	14	No	No	Yes	Yes
<b>ANTI-CYCLE</b>	<b>E</b>	1	Anti Cycle Time	15	No	Yes	Yes	Yes
		2	Override Diff	15	No	Yes	Yes	Yes
		3	Min On/Off Delay Stages 1, 3	15	Yes	No	Yes	Yes
		4	Next On Delay	15	Yes	No	Yes	Yes
<b>CONTROL MODES</b>	<b>F</b>	1	Cascade	15	No	No	Yes	Yes
		2	Modbus	15	No	No	Yes	Yes
		3	Modbus Time	15	No	No	Yes	Yes
<b>CASCADE</b>	<b>G</b>	1	Boiler Address	15	No	No	Yes	Yes
		2	Max Cascade Setpoint	15	No	No	Yes	Yes
		3	Cascade Offset	15	No	No	Yes	Yes
		4	Cascade Diff	15	No	No	Yes	Yes
<b>CIRC. PUMP</b>	<b>H</b>	1	PH Pump Delay	16	No	No	Yes	Yes
		2	PH Pump Off	16	No	No	Yes	Yes
		3	PH Pump Purge	16	No	No	Yes	Yes
<b>SERV. NOTIFICATION</b>	<b>I</b>	1	Service Interval Time	16	No	No	Yes	Yes
		2	Service Interval Run	16	No	No	Yes	Yes
		3	Service Operations	16	No	No	Yes	Yes
		4	Reset Service	16	No	No	Yes	Yes
		5	Accept PPlug	16	No	No	Yes	Yes

# 1 Service *(continued)*

## Viewable and changeable control parameters

### CAUTION

Before changing parameters, note the settings so that the unit can be returned to its original operating parameters.

### A: General

#### A1: User code

The User Code allows the user to access and change a limited number of control parameters. The access code can be changed by the user or the installer to a code of their choosing. To change the code, parameter **A1** must be accessed. The default code is 0704. The code can be changed one digit at a time by using the arrow keys on the display.

#### A2: Date and time

The control uses an internal clock for the night setback feature and for logging of events. For these features to work correctly, the clock must be set when the unit is first installed or any time the unit has been powered off for more than 30 days. To set the clock, parameter **A2** must be accessed. The date and time are displayed as “YY:MM:DD W hh:mm”. YY = year, MM = month, DD = date, W = day (1 = Monday, 2 = Tuesday, etc.), hh = hour (24 hour time; 2:00 PM = 14:00), mm = minutes.

### NOTICE

The internal clock does not adjust for Daylight Savings Time and therefore, will require a manual adjustment.

#### A3: Software version

The software version allows the user to view the software version in use by the control. This software controls the operation of the unit. When a new software version becomes available, the existing control can be replaced with a new control to update the software.

#### A4: Temperature units

The control can be configured to display temperature in either °C or °F. This parameter can be changed by the user or the installer by accessing parameter **A4**. The default is °F.

### B: Temperature settings

#### B1: Pool Set point

The PH user set point sets the pool temperature set point. This parameter can be changed by the user or the installer by accessing parameter **B1**. The temperature range of this parameter is 50°F (10°C) to 108°F (42°C). The default value is 80°F (27°C).

#### B2: PH Minimum set point

The PH minimum set point sets the minimum water temperature set point that can be used for pool heater operation. The user or installer will not be able to program the control with a lower PH set point. This parameter can only be changed by the installer by accessing parameter **B2**. The temperature range of this parameter is 32°F (0°C) to 105°F (40°C). The default value is 70°F (21°C).

#### B3: PH Maximum set point

The PH maximum set point sets the maximum water temperature set point that can be used for pool heater operation. The user or installer will not be able to program the control with a higher PH set point. This parameter can only be changed by the installer by accessing parameter **B3**. The temperature range of this parameter is 32°F (0°C) to 108°F (42°C). The default value is 108°F (42°C).

#### B4: PH Offset

The PH offset sets how many degrees above set point the temperature has to go before the unit will shut off. This parameter can only be changed by the installer by accessing parameter **B4**. The temperature range of this parameter is 0°F (0°C) to 54°F (30°C). The default value is 2°F (1°C).

#### B5: PH Differential

The PH differential sets how many degrees below the turn off temperature the temperature has to go before the unit will turn on. This parameter can only be changed by the installer by accessing parameter **B5**. The temperature range of this parameter is 0°F (0°C) to 54°F (30°C). The default value is 4°F (2°C).

#### B6: Manual reset high limit

The CXi™ control includes an integrated manual reset high limit (MRHL) feature, based on the outlet temperature. The set point for the MRHL is adjusted using parameter **B6**. The temperature range of this parameter is 32°F (0°C) to 210°F (99°C). The default value is 200°F (93°C).

#### B7: PH supply high limit

The CXi™ control also includes an integrated auto reset high limit (ARHL) feature, based on the pool supply temperature. The temperature range of this parameter is 101.3°F (38°C) to 110°F (43°C). The default value is 110°F (43°C).

### C: Data logging

#### C1: Hours running PH

The hours running PH parameter shows the total number of hours the unit has been in the PH firing mode. This parameter can be viewed by the user and the installer by accessing parameter **C1**.

# 1 Service

## C2: Ignition attempts

The burner cycles parameter shows the total number of times the unit has attempted to fire. This parameter can be viewed by the user and the installer by accessing parameter **C2**.

## C3: Show last 10 lockouts

The control will log the 10 most current lockouts with the date and time the lockout occurred. This parameter can be viewed by the user and the installer by accessing parameter **C3**.

## D: Functions

### D1: Reset last 10 lockouts

The reset last 10 lockouts parameter allows the lockout counter to be reset to 0. This parameter can only be cleared by the installer by accessing parameter **D1**. Once accessed, press the RESET key to clear the counter.

### D2: Service mode delay

By pressing the PREVIOUS and NEXT keys on the front of the display for five (5) seconds, the control will be placed in Service Mode. This will override all other heat demands. The Service Mode allows the installer to set the unit to firing rate for the purpose of combustion analysis. The delay sets the length of time the unit will stay in the Service Mode if no keys have been pressed before going back to its original state. This parameter can only be changed by the installer by accessing parameter **D2**. The time range of this parameter is 0 to 40 minutes. The default value is 20 minutes.

### D3: Display timeout

Whenever a button on the display is pushed, the backlight on the LCD is turned on, and a delay timer is reset. When this timer expires, the backlight turns off, and the display returns to the first Status Screen. The value of this timer can be adjusted using parameter **D3**. The range of this timer is 0 to 255 seconds. Setting this parameter to 0 disables the backlight. The default value is 60 seconds.

### D4: Bypass valve time

A 3-way bypass valve is installed between the outlet and the inlet of the heater. The CXi™ control is set to automatically control this valve to maintain the inlet temperature above the condensing temperature. Different valves require different amounts of time to open and close completely. The CXi™ control needs to know how long this takes in order to control the bypass valve properly. This time can be adjusted using parameter **D4**. When using the factory installed bypass valve, no adjustment is required. The range of this parameter is 0 to 255 seconds. The default value is 20 seconds.

### D5: Freeze protection pump on

In order to prevent the water in the heater from freezing, the CXi™ control turns on the unit pump whenever the inlet temperature goes below the minimum temperature. This temperature can be adjusted by using parameter **D5**. The range of this parameter is 32°F (0°C) to 104°F (40°C). The default value is 45°F (7°C).

### D6: Freeze protection burner on

If the inlet temperature continues to drop after starting the pump (see *Freeze Protection Pump On*), and the inlet temperature goes below a second minimum temperature, the first stage will fire. This second temperature can be adjusted by using parameter **D6**. The temperature range of this parameter is 32°F (0°C) to 104°F (40°C). The default value is 37°F (3°C).

### D7: Freeze protection differential

Once the pump has turned on, this parameter determines how much the inlet temperature must rise before the pump turns off. Similarly, once Stage 1 has turned on, this parameter also determines how much the inlet temperature must rise before Stage 1 turns back off. This temperature differential can be adjusted using parameter **D7**. The temperature range of this parameter is 0° to 72°F (40°C). The default temperature is 5°F (3°C).

# 1 Service *(continued)*

## E: Anti-cycling

### E1: Anti-cycle time

Once a PH demand has been satisfied, a set amount of time must elapse before the control will respond to a new demand. The control will block the new heat demand and anti-cycling will be shown in the display until the time has elapsed or the water temperature drops below parameter E2. This parameter can be changed by the installer by accessing parameter E1. The time range for this parameter is 0 minutes to 40 minutes. The default value is 1 minute.

### E2: Anti-cycle override differential

The control will bypass the anti-cycling time if the inlet water temperature drops too far. The control will use the water temperature at the time it shut off as the starting point. If the temperature drops below the temperature parameter the control will abort anti-cycling and allow the unit to fire. This parameter can be changed by the installer by accessing parameter E2. The temperature range of this parameter is 0°F (0°C) to 54°F (30°C). The default value is 10°F (5°C).

### E3: Minimum on / off delay stages 1, 3

Whenever Stage 1 or Stage 3 (if used) starts or stops, a timer is started. This timer must expire before that stage can turn off or back on. To adjust this time delay, access parameter E3. The range of this parameter is 0 to 255 seconds. The default value is 60 seconds.

### E4: Delay between stages 1, 3

Whenever Stage 1 or Stage 3 (if used) turns on, a timer must expire before another Stage 1 or 3 can turn on, whether in the same heater, or in another heater in a Cascade. To adjust this time delay, access parameter E4. The range of this parameter is 0 to 255 seconds. The default value is 60 seconds.

## F: Control modes

### F1: Cascade (active / inactive)

Pool heaters may be part of a group of units sequenced together. When so connected, each heater must be programmed to operate as part of the Cascade. This is done by setting the Cascade to Active. This setting is adjustable by the installer by accessing parameter F1. The default value is Inactive.

### F2: ModBus (active / inactive)

When the optional ModBus board is installed, the heater can be monitored and controlled by a Building Control System (BCS). If the heater is to be controlled through ModBus, parameter F2 must be set to ACTIVE. The default value is Inactive.

### F3: ModBus timeout

When the heater is being controlled or is receiving temperature readings through ModBus, the information sent to the heater must be refreshed periodically. If the heater does not receive new information after a timeout, it will revert to local temperature readings and control. This prevents the heater from running for too long should the ModBus connection be lost. To adjust the length of this timeout, access parameter F3. The range of this parameter is 0 to 120 seconds. The default value is 10 seconds.

## G: Cascade

### G1: Boiler address

The heater designated as the Leader needs to be programmed with address 0. All the Member heaters require addresses from 1 to 7, and the addresses must be different for each Member. The addresses can be in any order, regardless of the order in which the units are wired together. This parameter is adjustable by the installer by accessing parameter G1. The default address is 1.

### G2: Max. outlet set point

When pool heaters are connected in a Cascade, this parameter determines the set point used by the individual heaters. When a heater is commanded to fire by the Leader heater, it will attempt to achieve this temperature at its outlet. The Leader heater will limit the modulation of the last heater to fire in order to hold the temperature at the pool sensor to the user set point. If any of the heater outlet temperatures reach the max. cascade set point, the heater will then modulate down on its own in order to keep its outlet temperature within the max. cascade set point. Therefore, this parameter can be used to limit the outlet temperatures of all the heaters in a Cascade. This parameter is adjustable by the installer by accessing parameter G2. The temperature range for this parameter is 32°F (0°C) - 261°F (127°C). The default max. cascade set point is 185°F (85°C).

### G3: Cascade offset

This parameter determines how much the temperature must go above set point before the lead heater will turn off. This parameter can be adjusted by the installer by accessing parameter G3. The temperature range for this parameter is 0°F (0°C) - 54°F (30°C). The default value is 9.9°F (5°C).

### G4: Cascade differential

This parameter determines how much the temperature must go below the turn off temperature (Set point + Offset) before the lead heater turns on. This parameter can be adjusted by the installer by accessing parameter G4. The temperature range for this parameter is 0°F (0°C) - 54°F (30°C). The default value is 19.8°F (11°C).

# 1 Service

## H: Circulation pumps

### H1: PH pump delay

The system pump delay parameter sets the length of time the unit pump (if connected) will run after a PH demand has been satisfied. This parameter is adjustable by the installer by accessing parameter **H1**. The time range for this parameter is 1 minute to 40 minutes. The default time is 30 seconds.

### H2: PH pump off

The CXi™ control can force the unit pump to run for a set period of time before firing the heater, if the pump had been off for too long. To set the length of time the unit pump must be off before this feature becomes active, the installer must access parameter **H2**. The time range for this parameter is 0 minutes to 240 minutes. The default value is 0 minutes (disabled).

### H3: PH pump purge

Once the time period defined by parameter **H2** has elapsed, the CXi™ control will turn the unit pump on at the start of the next call for heat, then wait a period of time before firing the heater. This delay time can be adjusted by the installer by accessing parameter **H3**. The time range for this parameter is 0 minutes to 240 minutes. The default value is 0 minutes (disabled).

## I: Service Notification

### I1: Service interval time (months)

When the heater control determines that a scheduled service is due based on days of installation, the heater display will alternate the standard display text with the message SERVICE DUE every 5 seconds. This parameter is adjustable by the installer by accessing parameter **I1**. The time range for this parameter is 0 months to 36 months. The default time is 12 months.

### I2: Service runtime (hours)

When the heater control determines that a scheduled service is due based on the hours of actual operation, the display will alternate the standard display text with the message SERVICE DUE every 5 seconds. This parameter is adjustable by the installer by accessing parameter **I2**. The time range for this parameter is 0 hours to 100,000 hours. The default time is 10,000 hours.

### I3: Service operations

When the heater control determines that a scheduled service is due based on the number of cycles, the display will alternate the standard display text with the message SERVICE DUE every 5 seconds. This parameter is adjustable by the installer by accessing parameter **I3**. The range for this parameter is 0 cycles to 100,000 cycles. The default is 10,000 cycles.

### I4: Reset service reminder

Once servicing has been completed, the service notification counter should be reset. This parameter can be reset by the installer by accessing parameter **I4**. Once accessed, press the RESET key to reset the service notification counter.

### I5: Personality plug

After replacing a control board, the new control will require the installer to verify the model in which it is installed. As soon as the power is turned on, the screen will display “Wrong ID Plg”. Locate the label attached to the front of the control panel showing the personality ID number of that unit. Note the number written on the label. Access parameter **I5**. That number should appear after the word “Setting:” on the bottom line. If this number matches the number on the label, press “Enter”.



## 2 Maintenance

### Maintenance and annual startup

Table 2A\_Service and Maintenance Schedules

<b>Service technician</b> (see the following pages for instructions)		<b>Owner maintenance</b> (see the User's Information Manual for instructions)		
<b>ANNUAL START-UP</b>	<b>General:</b>			
	<ul style="list-style-type: none"> <li>• Address reported problems</li> <li>• Inspect interior; clean and vacuum if necessary;</li> <li>• Check for leaks (water, gas, flue, condensate)</li> <li>• Examine venting system</li> <li>• Check system water pressure/system piping/expansion tank</li> <li>• Check control settings</li> <li>• Check igniters</li> <li>• Check wiring and connections</li> <li>• Check flue gas passageways</li> <li>• Flame inspection (stable, uniform)</li> <li>• Inspect and clean the burners</li> <li>• Check manifold gas pressures</li> <li>• Perform start-up checkout and performance verification per the Startup Section in the Installation and Operation Manual.</li> </ul>	<b>Daily</b>	<ul style="list-style-type: none"> <li>• Check appliance area</li> <li>• Check pressure/temperature gauge</li> </ul>	
	<b>If combustion or performance indicate need:</b>		<b>Monthly</b>	<ul style="list-style-type: none"> <li>• Check vent piping</li> <li>• Check air piping</li> <li>• Check relief valve</li> <li>• Replace combustion air filter</li> </ul> <p><b>Note:</b> More frequent replacement may be necessary in dirty environments. Do not use pleated filters.</p>
	<ul style="list-style-type: none"> <li>• Clean heat exchanger with a stiff bristle brush</li> <li>• Remove and clean burners using water. Dry before re-assembling.</li> <li>• Clean the blower wheel with a brush and vacuum. Do not let dirt from cleaning get pulled into the blower.</li> </ul>		<b>Periodically</b>	<ul style="list-style-type: none"> <li>• Test low water cutoff (if used)</li> <li>• Reset button (low water cutoff)</li> </ul>
			<b>Every 6 months</b>	<ul style="list-style-type: none"> <li>• Check appliance piping (gas and water) for leaks</li> <li>• Operate relief valve</li> </ul>
		<b>End of season months</b>	<ul style="list-style-type: none"> <li>• Shut appliance down</li> </ul>	

## 2 Maintenance



### WARNING

Follow the service and maintenance procedures given throughout this manual and in component literature shipped with the appliance. Failure to perform the service and maintenance could result in damage to the appliance or system. Failure to follow the directions in this manual and component literature could result in severe personal injury, death, or substantial property damage.



### WARNING

The appliance should be inspected annually only by a qualified service technician. In addition, the maintenance and care of the appliance designated in Table 2A and explained on the following pages must be performed to assure maximum appliance efficiency and reliability. Failure to service and maintain the appliance and system could result in equipment failure.



### WARNING

Electrical shock hazard – Turn off power to the appliance before any service operation on the appliance except as noted otherwise in this instruction manual. Failure to turn off electrical power could result in electrical shock, causing severe personal injury or death.

### CAUTION

Be sure to shut the pool heater OFF when backwashing the filter.

### Address reported problems

1. Inspect any problems reported by the owner and correct before proceeding.

### Inspect appliance area

1. Verify that appliance area is free of any combustible materials, gasoline and other flammable vapors and liquids.

### Inspect appliance interior

1. Remove the outer access panels and inspect the interior of the appliance.
2. Vacuum any sediment from inside the appliance and components. Remove any obstructions.

### Check all piping for leaks

1. Inspect all water and gas piping and verify to be leak free.
2. Look for signs of leaking lines and correct any problems found.
3. Check gas line using the procedure found in the *Gas Connections* of the Installation and Operation Manual.

### Flue vent system and air piping

1. Check for gastight seal at every connection, seam of air piping, and vent piping periodically inspected by a qualified service agency.



### WARNING

Venting system must be sealed gastight to prevent flue gas spillage and carbon monoxide emissions, which will result in severe personal injury or death.

### Combustion air filter

This appliance has a standard air filter located at the combustion air inlet at the rear of the appliance. This filter helps ensure clean air is used for the combustion process. Check this filter every month and replace. The filter size on the 500,000 - 750,000 Btu/hr models is 12" x 12" x 1". You can find these commercially available at any home center or HVAC supply store. Do not use pleated filters.

### Check water system

1. Verify all system components are correctly installed and operational.
2. Inspect automatic air vents and air separators. Remove air vent caps and briefly press push valve to flush vent. Replace caps. Make sure vents do not leak. Replace any leaking vents.

## 2 Maintenance *(continued)*

### Check relief valve

1. Inspect the relief valve and lift the lever to verify flow. Before operating any relief valve, ensure that it is piped with its discharge in a safe area to avoid severe scald potential. Read the *Water Connections* Section of the Installation and Operation Manual before proceeding further.

#### **⚠ WARNING**

Safety relief valves should be re-inspected **AT LEAST ONCE EVERY THREE YEARS**, by a licensed plumbing contractor or authorized inspection agency, to ensure that the product has not been affected by corrosive water conditions and to ensure that the valve and discharge line have not been altered or tampered with illegally. Certain naturally occurring conditions may corrode the valve or its components over time, rendering the valve inoperative. Such conditions are not detectable unless the valve and its components are physically removed and inspected. This inspection must only be conducted by a plumbing contractor or authorized inspection agency – not by the owner. Failure to re-inspect the heater relief valve as directed could result in unsafe pressure buildup, which can result in severe personal injury, death, or substantial property damage.

#### **⚠ WARNING**

Following installation, the valve lever must be operated **AT LEAST ONCE A YEAR** to ensure that waterways are clear. Certain naturally occurring mineral deposits may adhere to the valve, rendering it inoperative. When manually operating the lever, water will discharge and precautions must be taken to avoid contact with hot water and to avoid water damage. Before operating lever, check to see that a discharge line is connected to this valve directing the flow of hot water from the valve to a proper place of disposal. Otherwise severe personal injury may result. If no water flows, valve is inoperative. Shut down the appliance until a new relief valve has been installed.

2. After following the above warning directions, if the relief valve weeps or will not seat properly, replace the relief valve. Ensure that the reason for relief valve weeping is the valve and not over-pressurization of the system due to expansion tank waterlogging or undersizing.

### Inspect/replace hot surface igniter

This unit uses a proven hot surface ignition module and a hot surface igniter. The hot surface ignition module is not repairable. Any modification or repairs will invalidate the warranty.

#### **⚠ WARNING**

Do not attempt to repair a faulty hot surface igniter or ignition module. Any modification or repairs may create hazardous conditions that result in property damage, personal injury, fire, explosion and/or toxic gases.

A faulty hot surface igniter or ignition module must be replaced with an identical part. A specification igniter and ignition module for this specific unit is available from your local distributor. **Do not use general purpose field replacement ignition modules or igniters.**

### Inspect/replace hot surface igniters

1. Turn off main electrical power to the appliance.
2. Turn off main manual gas shutoff to the appliance.
3. Remove lower front door to gain access to the hot surface igniter.
4. Locate the hot surface igniter. Disconnect the two power leads to the hot surface igniter.
5. Loosen and remove the two screws used to attach the igniter.
6. Remove the igniter from the combustion chamber door. Use care, do not hit or break the silicon carbide igniter. Do not contaminate the igniter by handling with oily or dirty hands.
7. Check the replacement igniter for cracks or damage before installing.
8. Ensure that the fiber gasket used to seal the base of the igniter to the combustion chamber door is reinstalled to seal the base of the replacement igniter.
9. Carefully insert the igniter into the opening of the combustion chamber door and re-attach the two screws removed in Step 5. Over-tightening may break the ceramic mounting flange.
10. Ensure that the igniter gasket is properly installed and seals the point of contact between the igniter and the combustion chamber door.
11. Reconnect the power leads to the igniter.
12. Replace the lower front door.
13. Turn on main gas supply and main power.
14. Test fire the appliance to ensure proper operation.

## 2 Maintenance

### Check all wiring

1. Inspect all wiring, making sure wires are in good condition and securely attached.

### Check control settings

1. Set the CXi™ control module display to Parameter Mode and check all settings. See Section 1 of this manual. Adjust settings if necessary. See Section 1 of this manual for adjustment procedures.
2. Check settings of external limit controls (if any) and adjust if necessary.

### Perform start-up and checks

1. Start appliance and perform checks and tests specified in *Start-up Section* of the Installation and Operation Manual.
2. Verify cold fill pressure is correct and that operating pressure does not go too high.

### Check burner flame

Visually check main burner flames at each start-up after long shutdown periods or at least every six months. The burner viewports are located on either end of the appliance.

**WARNING** The area around the burner viewport is hot and direct contact could result in burns.

**Figure 2-1** Flame Pattern Illustration

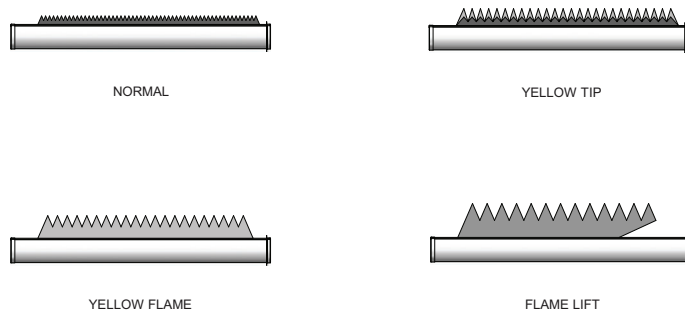

**Normal Flame:** A normal flame at 100% of burner input is blue, with slight yellow tips, a well defined flame and no flame lifting.

**Yellow Tip:** Yellow tipping can be caused by blockage or partial obstruction of air flow to the burner.

**Yellow Flames:** Yellow flames can be caused by blockage of primary air flow to the burner or excessive gas input. This condition **MUST** be corrected immediately.

**Lifting Flames:** Lifting flames can be caused by over firing the burner, excessive primary air or high draft.

If improper flame is observed, examine the venting system, ensure proper gas supply and adequate supply of combustion and ventilation air.

### Check flue gas passageways

Any sign of soot around the refractory, at the burners, or in the areas between the fins on the copper heat exchanger indicates a need for cleaning. The following cleaning procedure must only be performed by a qualified serviceman or installer. Proper service is required to maintain safe operation. Properly installed and adjusted units seldom need flue cleaning.

#### NOTICE

All gaskets/sealants on disassembled components or jacket panels must be replaced with new gaskets/sealants on reassembly. Gasket and sealant kits are available from your distributor.

#### CAUTION

When a Category IV vent system is disconnected for any reason, the flue must be reassembled and resealed according to the vent manufacturer's instructions.

### Inspect and clean burner

The burner should be removed for inspection and cleaned on an annual basis. An appliance installed in a dust or dirt contaminated environment may require cleaning of the burner on a 3 to 6 month schedule or more often, based on severity of the contamination. The fan assisted combustion process may force airborne dust and dirt contaminants, contained in the combustion air, into the burner. With sustained operation, non-combustible contaminants may reduce burner port area, reduce burner input or cause non-warrantable damage to the burner.

Use extreme care when operating an appliance for temporary heat during new construction. Airborne contaminants such as dust, dirt, concrete dust or drywall dust can be drawn into the burner with the combustion air and block the burner port area. An external combustion air filter is provided with the appliance. This filter helps ensure clean air is used for the combustion process. Check this filter every month and replace when it becomes dirty. The burner of an appliance used for temporary heat without a combustion air filter installed will probably require a thorough cleaning before the unit is placed into normal service.

## 2 Maintenance *(continued)*

Access to the burner will require the following steps:

1. Turn off main electrical power to the appliance.
2. Turn off main manual gas shutoff to the appliance.
3. Remove the lower outer front access door.
4. Disconnect the manifold(s) from the gas train using the union(s) just below each gas valve.
5. Disconnect the wiring to the hot surface igniter(s) and ground.
6. Disconnect burner pressure line at burner.
7. Remove the screws from the manifold mounting bracket(s) and remove the manifold(s).
8. Remove the screws from the burner mounting flanges and slide the burner(s) out toward the front of the unit. Use caution to prevent damage to the burners, refractory, hot surface igniter, and wiring.
9. Remove soot from the burners with a stiff bristle brush. Dirt may be removed from the burner ports by rinsing the burner thoroughly with water. Drain and dry burners before re-installing. Damaged burners must be replaced.
10. Reassemble in reverse order.

### NOTICE

When installed in a dusty and dirty location, the burners may require cleaning on a 3 to 6 month schedule or as needed, based on the severity of contamination. Contaminants can be drawn in with the combustion air. Non-combustible particulate matter such as dust, dirt, concrete dust, or drywall dust can block burner ports and cause non-warrantable failure. The standard inlet air filter will help eliminate dust and dirt from entering the unit.

### NOTICE

While burners are removed, check the heat exchanger surface for sooting. If present, the heat exchanger must be cleaned. Reference the *Heat Exchanger Cleaning* procedures in this manual.

## Checking combustion air pressure

The combustion air fans are factory pre-set and should not require adjustment in most cases. Follow the steps in the *Checking / Adjusting Combustion Air Pressure* Section to adjust the fan if a continuous Low Air status code occurs.

### NOTICE

On the 500,000 - 750,000 Btu/hr models, the air shutter is adjusted to the side of the fan as depicted in FIG. 2-2.

Check for proper installation and draft in the venting system prior to any adjustments. Correct as needed.

**Figure 2-2** Adjusting air shutter

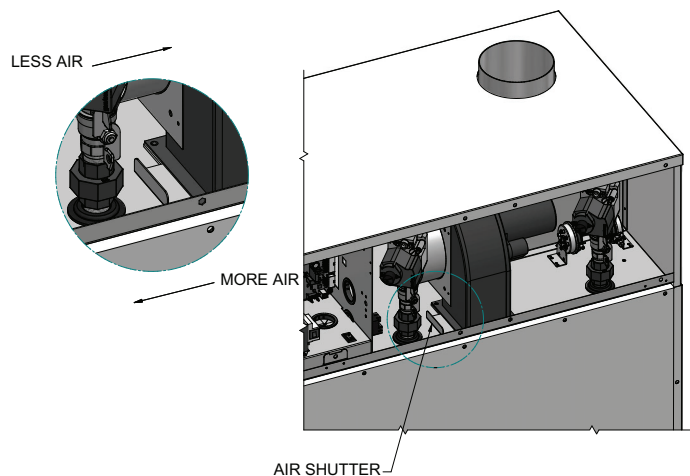

## 2 Maintenance

### Adjusting combustion air pressure

The following is a recommended method for setting the combustion air pressure. The following pressure settings are for installations up to 4000 feet altitude. Contact the factory for high altitude air pressure settings.

Upon removal of the upper front doors, locate the capped tee in the pressure tubing that connects between the inner top and the gas valves. Remove this cap and connect a hose from the tee to a manometer.

#### For 500,000 - 750,000 Btu/hr models (reference FIG. 2-2)

1. The combustion air chamber pressure for these models is typically 1.2 - 1.3 inches water column when the fan is at high speed.
2. If adjustment is necessary, slightly loosen the nuts connecting the fan to the inner top.
3. Adjust the air shutter located underneath the fan assembly to obtain the desired chamber pressure. Slide the shutter inward to decrease the chamber pressure or outward to increase the chamber pressure.
4. Once the adjustment procedure is complete, tighten all connections, disconnect the manometer, and replace the cap at the tee.
5. Check all connections and test fire the unit.
6. Replace all panels.

### Checking manifold gas pressure

The gas regulator on the combination gas valve is adjustable to supply the proper manifold pressure for normal operation. The gas valves are factory pre-set and should not need adjusting in most cases. Gas manifold pressures are listed in Table 2B on page 23.

Gas manifold pressures may be checked with the use of a manometer. Follow the steps in the *Checking Combustion Air Pressure Section* prior to checking the manifold pressures.

### Checking manifold gas pressure

1. Turn the appliance power switch to the “OFF” position.
2. Remove the upper outer access panels.
3. Remove the 1/8" hex plug from the downstream side of the gas valve (see FIG. 2-3). Install a fitting in the tap and connect a hose from the tap to a manometer.
4. Connect a hose from the tee used to measure the combustion air pressure to the other side of the manometer.
5. Turn the appliance power switch to the “ON” position.
6. With the unit at high fire, check and record the manifold pressure of the valve. The manifold pressure will be the sum of the two pressure readings (reference Table 2B).
7. Repeat this process with each gas valve.

**⚠ WARNING** Overfire and underfire hazards! Possible fire, explosion, overheating, and component failure. Do not attempt to adjust firing rate of the appliance. The firing rate must be adjusted only by factory trained personnel.

#### If you must adjust the gas valve regulator pressure, follow the steps below:

1. Remove the cap covering the manifold pressure adjustment screw (see FIG. 2-3). **Note:** Once the cap is removed, the pressure shown on the manometer will change and the unit may turn off.
2. Make a slight adjustment to the manifold pressure adjustment screw. Turning the screw clockwise increases manifold pressure and counterclockwise decreases manifold pressure.
3. Replace the cap and check the manifold pressure. **Note:** Allow the unit to re-light if necessary.
4. Repeat the steps above to match the manifold pressures from Table 2B.
5. Once the adjustment procedure is complete, turn off the appliance, disconnect the manometer, replace and tighten all connections, and replace all panels.
6. Turn on the appliance and test fire the unit.
7. Repeat this process with each gas valve.

## 2 Maintenance *(continued)*

Figure 2-3\_Measuring manifold gas pressure

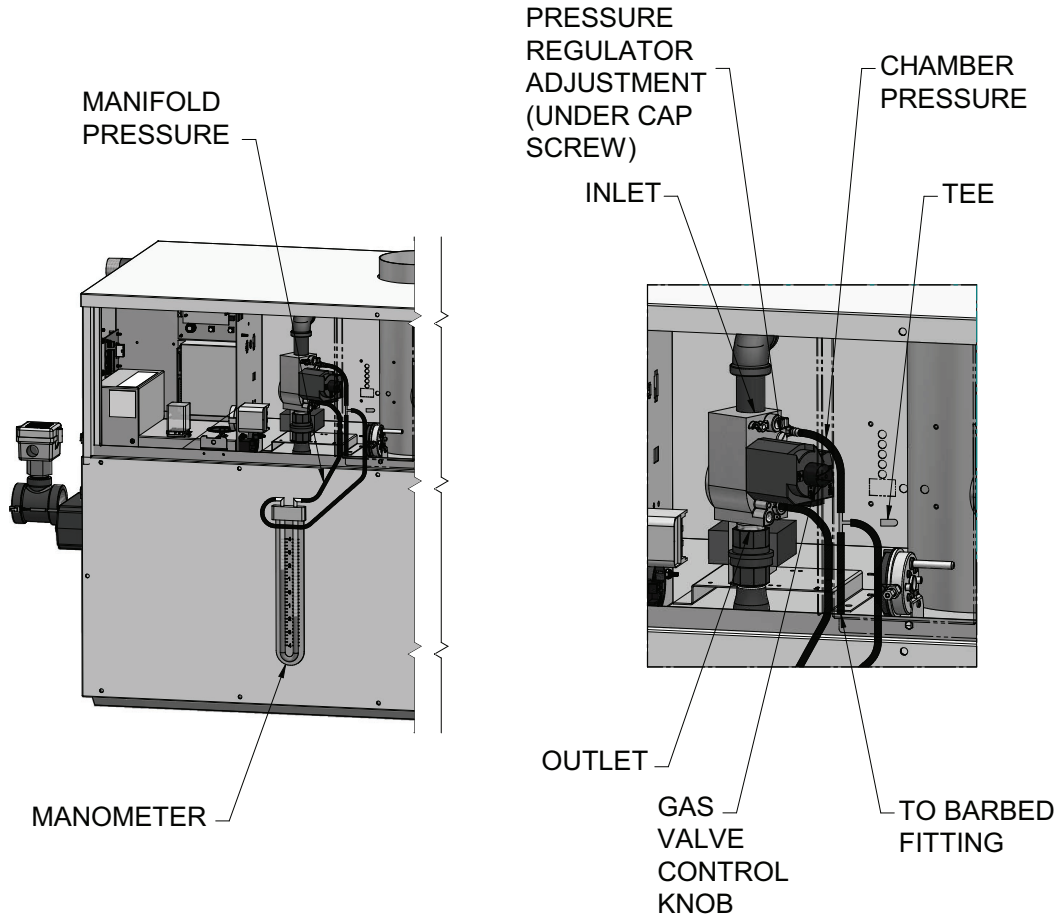

**TABLE 2B**  
**Net Manifold Pressure**  
**Regulator Pressure Less**  
**Front Chamber Pressure**

MODEL	Nat. Gas	LP
500 - 750	1.8" w.c.	4.6" w.c.

## 2 Maintenance

### Inspect and clean the heat exchanger

1. Turn off the main electrical power to the appliance.
2. Turn off the main manual gas shutoff to the appliance.
3. Remove the lower outer front access door.
4. Disconnect the manifold(s) from the gas train using the union(s) just below each gas valve.
5. Disconnect wiring to the hot surface igniter(s) and ground.
6. Disconnect burner pressure line at burner.
7. Remove the screws from the manifold mounting bracket(s) and remove the manifold(s).
8. Remove the screws from the burner mounting flanges and slide the burner(s) out toward the front of the unit. Use caution to prevent damage to the burners, refractory, hot surface igniter, and wiring.
9. Remove the inner jacket panel mounting screws and slide the panel assembly out toward the front of the appliance. Use caution to prevent damage to the refractory and hot surface igniter.
10. Check “V” baffles along the front and back edges of the heat exchanger (FIG. 2-4). Remove and clean if necessary.
11. Remove soot from the heat exchanger with a stiff bristle brush. Use a vacuum to remove loose soot from the surfaces and inner chamber.
12. If additional cleaning is required, the heat exchanger can be removed by disconnecting all water piping to the heat exchanger, removing the screws holding the heat exchanger to the inner left side panel, and sliding the heat exchanger towards the front of the appliance. Once the heat exchanger is removed from the appliance, a garden hose can be used to wash the tubes to ensure that all soot is removed from the heat exchanger surfaces.

**NOTICE** Do not wet the refractory located on the inside of the combustion chamber.

13. Ensure that all burner ports are cleaned to remove any soot (reference this section).
14. Carefully reinstall the heat exchanger, “V” baffles, and frame runners if removed from the appliance.

**NOTICE** Make sure the frame runners seal securely where they contact the front and rear compartment refractory.

15. Carefully reinstall inner jacket panels, burners, manifolds, wires and hoses. Use new gasket material to ensure a proper air seal.
16. Reassemble all gas and water piping. Test for gas leaks.
17. Reassemble outer jacket panels.
18. Cycle the appliance and check for proper operation.

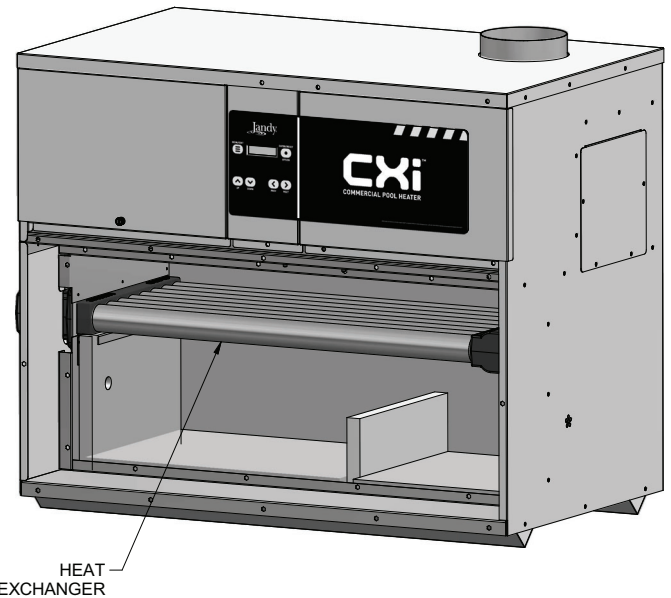

**Figure 2-4** Location of the Heat Exchanger Inside Jacket

### Review with owner

1. Review the User's Information Manual with the owner.
2. Emphasize the need to perform the maintenance schedule specified in the User's Information Manual (and in this manual as well).
3. Remind the owner of the need to call a licensed contractor should the appliance or system exhibit any unusual behavior.
4. Remind the owner to follow the proper shutdown procedure and to schedule an annual start-up at the beginning of the next heating season.



### 3 Troubleshooting

#### ⚠ WARNING

Label all wires prior to disconnection when servicing controls. Wiring errors can cause improper and dangerous operation. Always disconnect power to the appliance before servicing. Failure to comply could result in severe personal injury, death, or substantial property damage.

#### ⚠ WARNING

Never jumper (bypass) any device except for momentary testing as outlined in the Troubleshooting chart. Severe personal injury, death, or substantial property damage can result.

#### Before troubleshooting:

- Have the following items:
  - Voltmeter that can check 120 VAC, 24 VAC, and 12 VDC.
  - Continuity checker.
  - Contact thermometer.
- Check for 120 VAC (minimum 102 VAC to maximum 132 VAC) to appliance.
- Make sure thermostat is calling for heat. Check for 24 VAC between S1 terminal 9 on the connection board and ground.
- Make sure all external limit controls are installed and operating.

#### Check the following:

- Wire connectors to control module are securely plugged in at the module and originating control.
- Gas pressures:

Refer to the Gas Connections Section of the Installation and Operation Manual for detailed information concerning the gas supply.

#### Check control module fuses

#### NOTICE

ALWAYS check control module fuses before replacing control module or any major components (blower, etc.). If one of these fuses is blown, it can prevent the control module or other components from operating.

- Turn OFF the power to the appliance at the external line switch.
- Remove front access cover.
- Inspect fuses F2, F4, F5, and F6, see FIG. 3-1 below.

Figure 3-1\_Control Module Fuses

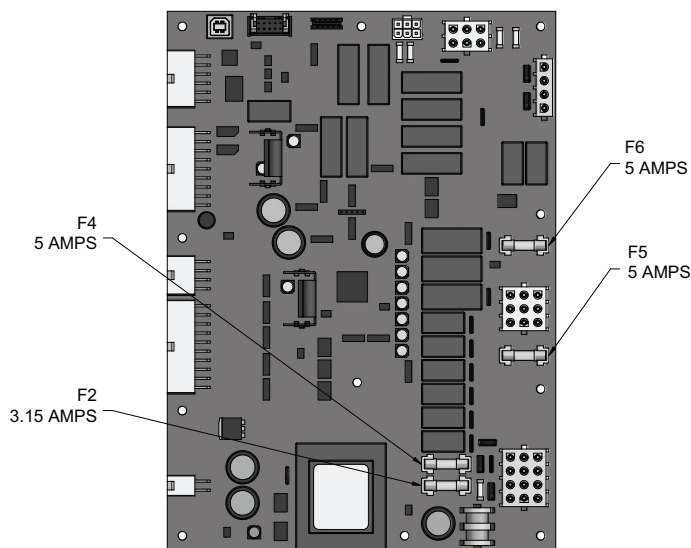

- The appliance is shipped with four (4) spare fuses in a plastic bag attached to the control panel.
- If necessary, replace open fuse (F2 is 3.15 amps and F4, F5, and F6 are 5 amps).

**Note:** Fuses F2 - F6 are all slow blow fuses.

#### ⚠ WARNING

Do not jumper fuse or replace with any fuse except as specified. Failure to comply could result in severe personal injury, death, or substantial property damage.

- Install front access cover after fuse inspection.
- Restore power to the appliance at the external line switch and verify heater operation (*Start-up Section* in the Installation and Operation Manual) after completing heater service.

### 3 Troubleshooting

Table 3A Troubleshooting Chart - No Display

FAULT	CAUSE	CORRECTIVE ACTION
<b>No Display</b>	- No 120 VAC supplied to unit.	<ul style="list-style-type: none"> <li>• Check external line switch, fuse, or breaker.</li> <li>• Check position of ON/OFF switch. Turn switch to the ON position.</li> <li>• Check 120 VAC through the ON/OFF switch. No voltage through switch, replace switch.</li> </ul>
	- Bad wiring connection.	<ul style="list-style-type: none"> <li>• Check wiring harness connection between the display board and the main control board. Connect the harness at both points.</li> </ul>
	- Blown fuse.	<ul style="list-style-type: none"> <li>• Replace fuse F6 on the main control board, see FIG. 3-1 on page 25 of this manual.</li> </ul>
	- Bad display board.	<ul style="list-style-type: none"> <li>• Replace board.</li> </ul>
	- Bad main control board.	<ul style="list-style-type: none"> <li>• Replace main control board.</li> </ul>
<b>No Burner Operation</b>	- Main control board temperature set point satisfied.	<ul style="list-style-type: none"> <li>• Review temperature setting.</li> </ul>
	- Remote thermostat satisfied.	<ul style="list-style-type: none"> <li>• Review remote thermostat setting.</li> </ul>
	- Unit locked out on fault.	<ul style="list-style-type: none"> <li>• Consult display for specific fault. Refer to fault descriptions on pages 29 - 35 of this manual for corrective actions.</li> </ul>
<b>Unit Does Not Modulate to 100%</b>	- Heater controlled by BMS.	<ul style="list-style-type: none"> <li>• Check BMS parameter settings. Optional PC software required.</li> </ul>
	- Outlet temperature too high.	
	- Delta T too high.	

### 3 Troubleshooting *(continued)*

#### Checking temperature sensors

The appliance temperature sensors (inlet water, outlet water, system water, tank water, flue, and outdoor air) are all resistance type devices. The following tables show the correct values for the sensors at various temperatures. Use an ohmmeter to read the resistance of the sensor at a known temperature. If the resistance of the sensor does not closely match its corresponding table, replace the sensor.

**Table 3B** Inlet/Outlet/System/Tank Sensor Resistance vs. Temperature

<b>S1a Inlet/Outlet/Pool Return/Supply A</b> (Wire Color - R and W)				<b>S1b Outlet/Pool Supply B</b> (Wire Color - Bk and G)			
Temperature	Resistance	Temperature	Resistance	Temperature	Resistance	Temperature	Resistance
50	19,553	158	2,004	50	40,030	158	3,478
68	12,690	176	1,464	68	25,030	176	2,492
86	8,406	194	1,084	86	16,090	194	1,816
104	5,715	212	816	104	10,610	212	1,344
122	3,958			122	7,166		
140	2,786			140	4,943		

### 3 Troubleshooting

Table 3C Troubleshooting Chart - Noisy System

FAULT	CAUSE	CORRECTIVE ACTION
<b>Noisy Operation</b>	- Gas supply problem.	• Refer to the <i>Gas Connections Section</i> of the Installation and Operation Manual for detailed information concerning the gas supply.
	- Gas/air mixture problem.	• Refer to the <i>Checking Manifold Gas Pressure and Combustion Analysis Procedure</i> on pages 21 and 22 of this manual for the proper settings. Verify that the vent/air intake lengths do not exceed the maximum listed in the <i>Venting</i> section of the Installation and Operation Manual.
	- Dirty/damaged burner.	• Refer to pages 20 and 21 in this manual for the burner removal and inspection procedure. Clean or replace the burner as necessary.
	- Low water flow through the heat exchanger.	• Refer to the <i>Water Connections Section</i> of the Installation and Operation Manual for minimum flow rates. Verify that the appliance is piped in a primary/secondary fashion and that the appliance and system pump are running on a call for heat.
	- Air in the piping system.	• Properly purge all air from the piping system.
	- Low system water pressure.	• Verify system pressure is a minimum of 12 PSI.
<b>No Pump Operation</b>	- Faulty pump relay.	• Replace relay.
	- Faulty pump.	• Replace pump.
	- Internal fault on control board.	• Check fuse F5. • Replace main control board. <b>Note:</b> Make sure the heater pump horse power (hp) does not exceed 1 hp.
<b>Relief Valve Opening</b>	- System pressure exceeds relief valve setting.	• Lower the system pressure below the rating of the supplied relief valve or replace the standard relief valve with a higher rated valve up to the maximum pressure of the heat exchanger.
	- Outlet water temperature in excess of 210°.	• Check set point of temperature control. • Check temperature rise across heat exchanger. Refer to the temperature rise chart in the <i>Water Connections Section</i> of the Installation and Operation Manual.

### 3 Troubleshooting *(continued)*

**Table 3D** Troubleshooting Chart - Fault Messages Displayed on Operator Interface

FAULT	DESCRIPTION	CORRECTIVE ACTION
<p><b>Gas Pressure SW</b> (Will require a manual reset once the condition has been corrected.)</p>	<ul style="list-style-type: none"> <li>- Either the optional manual reset low gas pressure switch or the optional manual reset high gas pressure switch tripped.</li> <li>- Models 992 - 2072 (natural gas) - Automatic Reset Low Gas is open.</li> </ul>	<ul style="list-style-type: none"> <li>• Reset the pressure switches.</li> <li>• Measure the supply gas pressure to determine cause of failure. Refer to the <i>Gas Connections Section</i> of the Installation and Operation Manual for detailed information concerning the gas supply.</li> <li>• Correct the supply gas pressure if necessary.</li> </ul>
<p><b>Flow Switch/ LWCO</b> (Lockout will reset automatically after 5 minutes or may be reset immediately once condition has been corrected. Press the RESET button on the CXi™ display to reset.)</p>	<p>Either the flow switch or the optional low water cutoff is not making.</p>	<ul style="list-style-type: none"> <li>• Check pump operation on a call for heat.</li> <li>• Check for closed valves or obstructions in the water piping.</li> <li>• Verify system is full of water and all air has been purged from the system.</li> </ul>
<p><b>Flame Sequence</b> (Will require a manual reset once the condition has been corrected. Press the RESET button on the CXi™ display to reset.)</p>	<p>The flame detector circuit is seeing a flame signal while the gas valve is de-energized.</p>	<ul style="list-style-type: none"> <li>• Check supply voltage for proper polarity.</li> <li>• Check that the gas valve is closed.</li> <li>• Check external wiring for voltage feedback.</li> <li>• Check the internal wiring for bad connections.</li> <li>• Replace main control board.</li> </ul>
<p><b>Anti-cycling</b></p>	<p>The main control board has received a call for heat too quickly after the previous call for heat has ended.</p>	<ul style="list-style-type: none"> <li>• The control board will release the call for heat after a set time period.</li> <li>• The control board will release the call for heat if the outlet temperature drops too quickly.</li> </ul>

### 3 Troubleshooting

Table 3D (continued from previous page) Troubleshooting Chart - Fault Messages Displayed on Operator Interface

FAULT	DESCRIPTION	CORRECTIVE ACTION
<p><b>No Flame Ign</b> (Will require a manual reset. Press the RESET button on the CXi™ display to reset.)</p>	<p>The unit has failed to prove burner flame upon ignition.</p>	<ul style="list-style-type: none"> <li>• Inspect igniter and associated wiring for damage and connection. Reference page 19 of this manual for removal and cleaning procedure. Replace if necessary.</li> <li>• Check for proper electrical grounding of unit.</li> <li>• Check incoming supply gas pressure. Refer to the <i>Gas Connections Section</i> in the Installation and Operation Manual for detailed information concerning the gas supply.</li> <li>• Verify that the tube from the gas valve to the combustion air chamber is connected and is not damaged.</li> <li>• Verify that the vent/air intake pipes are correctly installed and that there are no obstructions.</li> <li>• Inspect the burners. Reference pages 20 and 21 of this manual for removal and cleaning procedures. Replace if necessary.</li> <li>• Refer to the <i>Checking Manifold Gas Pressure and Combustion Procedure</i> on pages 21 and 22 of this manual for the proper settings.</li> <li>• Check for 24 VAC to the gas valve during the ignition attempt. If no voltage is present, check the wiring between the gas valve and the main control board.</li> <li>• Replace the wiring or the main control board as necessary.</li> </ul>
<p><b>HSI Current Low</b> (Will require a manual reset once the condition has been corrected. Press the RESET button on the CXi™ display to reset.)</p>	<p>Amp draw of the hot surface igniter did not meet the minimum requirement of 2.6 amps.</p>	<ul style="list-style-type: none"> <li>• Measure the amp draw of the hot surface igniter during the trial for ignition stage. If less than 2.6 amps replace the hot surface igniter.</li> <li>• If more than 2.6 amps replace the control module.</li> </ul>
<p><b>Flame CKT Error</b></p>	<p>The main control board has detected an internal fault.</p>	<ul style="list-style-type: none"> <li>• Replace the main control board.</li> </ul>

### 3 Troubleshooting *(continued)*

**Table 3D** (continued from previous page) Troubleshooting Chart - Fault Messages Displayed on Operator Interface

FAULT	DESCRIPTION	CORRECTIVE ACTION
<p><b>No Flame Running</b> (Will require a manual reset once the condition has been corrected. Press the RESET button on the CXi™ display to reset.)</p>	<p>The unit was running and lost the flame signal.</p>	<ul style="list-style-type: none"> <li>• Inspect igniter and associated wiring for damage and connection. Reference page 19 of this manual for removal and cleaning procedure. Replace if necessary.</li> <li>• Check for proper electrical grounding of unit.</li> <li>• Check incoming supply gas pressure. Refer to the <i>Gas Connections Section</i> of the Installation and Operation Manual for detailed information concerning the gas supply.</li> <li>• Verify that the tube from the gas valve to the combustion air chamber is connected and is not damaged.</li> <li>• Verify that the vent/air intake pipes are installed correctly and there are no obstructions.</li> <li>• Refer to the <i>Checking Manifold Gas Pressure and Combustion Analysis Procedure</i> on pages 21 and 22 of this manual for the proper settings.</li> <li>• Inspect the burners. Reference pages 20 and 21 of this manual for removal and cleaning procedures. Replace if necessary.</li> <li>• Replace the main control board.</li> </ul>
<p><b>Auto Reset High Limit</b></p>	<p>The outlet water temperature has exceeded the setting of the automatic reset high limit.</p>	<ul style="list-style-type: none"> <li>• Verify that the system is full of water and that all air has been properly purged from the system.</li> <li>• Verify that the appliance is piped properly into the heating system. Refer to the <i>Water Connections Section</i> of the Installation and Operation Manual for the proper piping methods for the CXi™.</li> <li>• Check 120 VAC to heater pump motor on a call for heat. If voltage is not present, check wiring back to the main control board. Replace the main control board if necessary.</li> <li>• If 120 VAC is present on a call for heat and the pump is not operating, replace the pump.</li> <li>• If the system pump is a variable speed pump, ensure that the system flow is not less than the heater flow.</li> <li>• Check temperature setting of the main control board.</li> <li>• Check resistance of water sensors and compare to Table 3B on page 27 of this manual. Replace sensor if necessary.</li> <li>• Replace outlet sensor.</li> </ul>

### 3 Troubleshooting

Table 3D (continued from previous page) Troubleshooting Chart - Fault Messages Displayed on Operator Interface

FAULT	DESCRIPTION	CORRECTIVE ACTION
<p><b>Manual Reset High Limit</b> (Will require a manual reset once condition has been corrected. Press the RESET button on the CXi™ display to reset.)</p>	<p>The outlet water temperature has exceeded the setting of the adjustable high limit.</p>	<ul style="list-style-type: none"> <li>• Verify setting of adjustable high limit.</li> <li>• Verify that the system is full of water and that all air has been properly purged from the system.</li> <li>• Verify that the appliance is piped properly into the system. <i>Refer to the Water Connections Section of the Installation and Operation Manual for proper piping methods for the CXi™.</i></li> <li>• Check 120 VAC to the pump motor on a call for heat. If voltage is not present, check wiring leading to the main control board. Replace the main control board if necessary.</li> <li>• If 120 VAC is present on a call for heat and the pump is not operating, replace the pump.</li> <li>• If the system pump is a variable speed pump, ensure the system flow is not less than the heater flow.</li> <li>• Check temperature setting of the main control board.</li> <li>• Check resistance of water sensors and compare to the tables on page 27 of this manual. Replace the sensor if necessary.</li> <li>• Replace outlet sensor or high limit.</li> </ul>
<p><b>Inlet Low</b></p>	<p>The inlet water temperature did not exceed 130° within 15 minutes of ignition.</p>	<ul style="list-style-type: none"> <li>• Check the wiring between the low voltage connection board and the 3-way valve.</li> <li>• Verify that the control applies 24 VAC between the “Close” terminal and the “COM” terminal on the 3-way valve after the heater fires. If 24 VAC is present and the valve does not move, replace the valve.</li> <li>• Replace the inlet sensor.</li> <li>• Replace the main control board.</li> </ul>
<p><b>Sensor Open</b> (Will require a manual reset once the condition has been corrected. Press the RESET button on the CXi™ display to reset.)</p>	<p>Either the inlet water, outlet water, system supply, system return, or outdoor temperature sensor has been disconnected.</p>	<ul style="list-style-type: none"> <li>• Check the sensors and their associated wiring. Repair or replace the sensor or wiring if damaged.</li> <li>• Measure the resistance of the sensors and compare the resistance to the tables on page 27 of this manual.</li> <li>• Replace the sensor if necessary.</li> </ul>
<p><b>Sensor Shorted</b> (Will require a manual reset once the condition has been corrected. Press the RESET button on the CXi™ display to reset.)</p>	<p>Either the inlet water, outlet water, system supply, system return, or outdoor temperature sensor has been shorted.</p>	<ul style="list-style-type: none"> <li>• Check the sensors and their associated wiring. Repair or replace the sensor or wiring if damaged.</li> <li>• Measure the resistance of the sensors and compare the resistance to the tables on page 27 of this manual.</li> <li>• Replace the sensor if necessary.</li> </ul>



### 3 Troubleshooting *(continued)*

**Table 3D** (continued from previous page) *Troubleshooting Chart - Fault Messages Displayed on Operator Interface*

<b>FAULT</b>	<b>DESCRIPTION</b>	<b>CORRECTIVE ACTION</b>
<p><b>Louver Proving</b> (Lockout will reset automatically after 5 minutes or may be reset immediately once condition has been corrected. Press the RESET button on the CXi™ display to reset.)</p>	<p>An optional remote proving switch is not making.</p>	<ul style="list-style-type: none"> <li>• Check function of remote devices.</li> <li>• Check for loose or misplaced jumper if proving switch is not installed.</li> </ul>
<p><b>APS Open</b> (Lockout will reset automatically after 5 minutes or may be reset immediately once condition has been corrected. Press the RESET button on the CXi™ display to reset.)</p>	<p>The air pressure switch did not make within 1 minute after the combustion air blower has been energized.</p>	<ul style="list-style-type: none"> <li>• Check air filter. Clean or replace as necessary.</li> <li>• Vent/air intake lengths exceed the maximum allowed lengths.</li> <li>• Check for blockage or obstruction in vent/air inlet pipe or at terminations.</li> <li>• Verify combustion air blower is operating. Replace if necessary.</li> </ul>
<p><b>APS Closed</b> (Lockout will reset automatically after 5 minutes or may be reset immediately once condition has been corrected. Press the RESET button on the CXi™ display to reset.)</p>	<p>The CXi™ control sensed that the air pressure switch was closed before the combustion air blower was energized.</p>	<ul style="list-style-type: none"> <li>• Check for jumper on air pressure switch.</li> <li>• Check for an unusually high negative draft in the vent stack.</li> </ul>
<p><b>Wrong ID Plug</b></p>	<p>Control module ID plug does not match parameter L5.</p>	<ul style="list-style-type: none"> <li>• Verify that ID plug is connected properly to connector X5 on the control module.</li> <li>• Verify that the wiring in the ID plug is not cut or damaged and that the wiring connectors are seated properly in the plug.</li> <li>• Verify that the number on the label on the control panel matches the number in parameter I5. If not, replace the control module.</li> <li>• When replacing control modules, verify that the number in parameter I5 matches the number on the label on the control panel (reference page 16 of this manual). If so, press the ENTER button on the CXi™ display. If not, replace the control module.</li> </ul>

### 3 Troubleshooting

Table 3D (continued from previous page) Troubleshooting Chart - Fault Messages Displayed on Operator Interface

FAULT	DESCRIPTION	CORRECTIVE ACTION
<p><b>Temp O/Shoot</b> (Lockout will reset automatically after 5 minutes or may be reset immediately once condition has been corrected. Press the RESET button on the CXi™ display to reset.)</p>	<p>The temperature rise across the heat exchanger has exceeded the set parameters for the appliance.</p>	<ul style="list-style-type: none"> <li>• Verify that the system is full of water and that all air has been properly purged from the system.</li> <li>• Verify that the appliance is piped properly into the filter system. Refer to the <i>Water Connections Section</i> of the Installation and Operation Manual for the proper piping methods.</li> <li>• Check for 120 VAC to the pump motor on a call for heat. If voltage is not present, check the wiring leading to the main control board. Replace the main control board if necessary.</li> <li>• If 120 VAC is present on a call for heat and the pump is not operating, replace the pump.</li> </ul>
	<p>Outlet water temperature has exceeded the maximum outlet water temperature.</p>	<ul style="list-style-type: none"> <li>• Verify that the system is full of water and that all air has been properly purged from the system.</li> <li>• Verify that the appliance is piped properly into the filter system. Refer to the <i>Water Connections Section</i> of the Installation and Operation Manual for the proper piping methods.</li> <li>• Check 120 VAC to the pump motor on a call for heat. If voltage is not present, check wiring leading to the main control board. Replace the main control board if necessary.</li> <li>• If 120 VAC is present on a call for heat and the pump is not operating, replace pump.</li> <li>• Replace the main control board.</li> </ul>
<p><b>Rem Ctrl Flt</b></p>	<p>External control is cycling too often.</p>	<ul style="list-style-type: none"> <li>• Check set point of the external control.</li> <li>• Check the wiring between the external control and the unit.</li> <li>• Replace the control.</li> </ul>
<p><b>Parameters Progr</b> (Will require a manual reset once the condition has been corrected. Press the RESET button on the CXi™ display to reset.)</p>	<p>After downloading parameters from a laptop, the main control board must be reset.</p>	<ul style="list-style-type: none"> <li>• Press the ENTER/RESET button on the CXi™ display panel.</li> </ul>

### 3 Troubleshooting *(continued)*

**Table 3D** (continued from previous page) Troubleshooting Chart - Fault Messages Displayed on Operator Interface

FAULT	DESCRIPTION	CORRECTIVE ACTION
<b>Service Blk</b>	While the unit is in Service Mode, the outlet temperature has exceeded 185°F (85°C).	<ul style="list-style-type: none"> <li>• Establish a heating load to remove heat from the system.</li> <li>• Verify that the system is full of water and that all air has been properly purged from the system.</li> <li>• Verify that the appliance is piped properly into the filter system. Refer to the <i>Water Connections Section</i> of the Installation and Operation Manual for the proper piping methods.</li> <li>• Check 120 VAC to the pump motor on a call for heat. If voltage is not present, check the wiring leading to the main control board. Replace the main control board if necessary.</li> <li>• If 120 VAC is present on a call for heat and the pump is not operating, replace the pump.</li> </ul>
<b>Low Voltage</b>	120 VAC input to the main control board has dropped below 100 VAC.	<ul style="list-style-type: none"> <li>• Check 120 VAC supply to the transformer.</li> <li>• Check wiring connections at the low voltage terminal strip.</li> <li>• Check the wire size/length to remote devices.</li> <li>• Replace the main control board.</li> </ul>
<b>Watch Dog Error</b>	The main control board has detected an internal fault.	<ul style="list-style-type: none"> <li>• Cycle main power.</li> <li>• Replace the main control board.</li> </ul>
<b>Write EEPROM</b>	The main control board has detected an internal fault.	<ul style="list-style-type: none"> <li>• Cycle main power.</li> <li>• Replace the main control board.</li> </ul>
<b>Program EEPROM</b>	The main control board has detected an internal fault.	<ul style="list-style-type: none"> <li>• Cycle main power.</li> <li>• Replace the main control board.</li> </ul>
<b>CRC Parameters</b>	The main control board has detected an internal fault.	<ul style="list-style-type: none"> <li>• Cycle main power.</li> <li>• Replace the main control board.</li> <li>• Restore default parameters using the PC program.</li> </ul>
<b>No Error Stored</b>	The main control board has detected an internal fault.	<ul style="list-style-type: none"> <li>• Press RESET.</li> <li>• Cycle main power.</li> <li>• Replace the main control board.</li> </ul>



©2019 Zodiac Pool Systems LLC. All rights reserved. All other trademarks are the property of their respective owners.

**Revision Notes:** Revision A (PCP #3000035644 / CN #500024063)  
initial release.

MM# 100324298 / DIR# 2000579556 Rev A

12/19