

# Original Owner's Manual



Crossfire

# Thank You

Congratulations on owning a new Meyer Crossfire. Since 1926, Meyer has been striving to build innovative, quality, hardworking equipment.

We want you to feel safe and secure with your investment. Please read and follow this manual to ensure your Meyer Crossfire stays in top operational condition. If you do experience an issue, your plow is backed by the industries best warranty and is servicable by any authorized Meyer dealer.

We appreciate you choosing Meyer and look forward to keeping the roads safe and clear with you.

# Table of Contents

- Warranty.....4
- Registration .....5
- EC Declaration of Conformity .....6
- Safety Guards .....7
- Safety Definitions & Warnings ..... 8-9
- Safety Decals..... 10
- Safety Decal Locations ..... 11
- Component Identification ..... 12-13
- Vehicle Loading ..... 14-15
- Installation / Assembly Instructions ..... 16-19
- Controller Harness .....20
- Brake Light & Work Light Harnesses .....21
- Controller..... 22-23
- Operating Instructions..... 24-25
- Maintenance..... 26-27
- Troubleshooting ..... 28-29
- Spreader Calibration ..... 30-31
- Warranty..... 32-33

# Warranty

Your operator's manual provides essential information on safety, operation, and maintenance. Failure to follow this operator's manual may result in damage to your equipment and affect your warranty.

Prior to use, please ensure your Crossfire is registered. Registering your Crossfire will upgrade your warranty from 2 years to 5 years\*. Your dealer may have done this for you. If not, you can register your Crossfire at...

[www.meyerproducts.com/product-registration](http://www.meyerproducts.com/product-registration)

Meyer's warranty covers manufacturing defects including welding, electrical, lights, controllers, and more.

The warranty does not cover abuse, misuse, bends, twists, paint, rust, corrosion, wear & tear, loss of time, incidentals, or similar issues.

For further information on the warranty, please review the pages 32 and 33.

All warranty work must be done by an authorized Meyer or Aebi-Schmidt dealer. Your local dealer can be found by visiting...

[www.meyerproducts.com/dealer-locator](http://www.meyerproducts.com/dealer-locator).

\* Your spreader must be registered to receive the extended 5 year warranty

# Registration

Once registered, you will be provided with a registration ID. Meyer recommends completing the fields below for future reference.

Registration ID \_\_\_\_\_

Purchase Date \_\_\_\_\_

Purchased From \_\_\_\_\_

Spreader Model \_\_\_\_\_

Serial Number \_\_\_\_\_

# EC Declaration of Conformity

For our product  
Machine:

Super V3, Drive Pro, Nite Saber Lights, Crossfire, Elite, Hot Shot, Blaster, Base Line

Type:

Plow  
Tailgate Spreader  
Insert Spreader  
Walk Behind Spreader

Directives:

We hereby declare that it has been designed and manufactured in accordance with the following directives:

2006/42/EC	EC Low Voltage Directive
2004/108/EC	EMC Directive
2006/42/EC	Machinery Directive

Corresponding documentation can be provided on request. Authorized person for doing this is:

Meyer Products  
18513 Euclid Avenue  
Cleveland, OH 44112-1084  
216-486-1313

Standards:

Following standards have been respected:

- BS EN 60204-1:2006/IEC 60204-1:2005: Safety of Machinery-Electrical Equipment of Machines-Part 1 General Requirements
- EN ISO 12100-1:2003: Safety of Machinery-Basic Concepts, General Principles of Design Part1: Basic Terminology and Methodology
- EN ISO 12100-2:2003: Safety of Machinery-Basic Concepts, General Principles of Design Part 2: Technical Principles
- EN 13021:2003+A1-Winter Service Machines-Safety Requirements
- EN 61000-6-2:2005-Generic Standards-Immunity for Industrial Environments
- EN 61000-6-4:20058-Generic Emission Standard, Part 2: Industrial Environment

In case of modification of the machine, not in consultation with Aebi Schmidt, this Declaration of Conformity becomes invalid.

  
Jason Ryant  
Operations

  
Jason Bartuseck  
General Manager Meyer

# Safety Guards

To prevent serious personal injury or death all safety guards/covers must be securely fastened in the proper location while equipment is operating or capable of being operated.

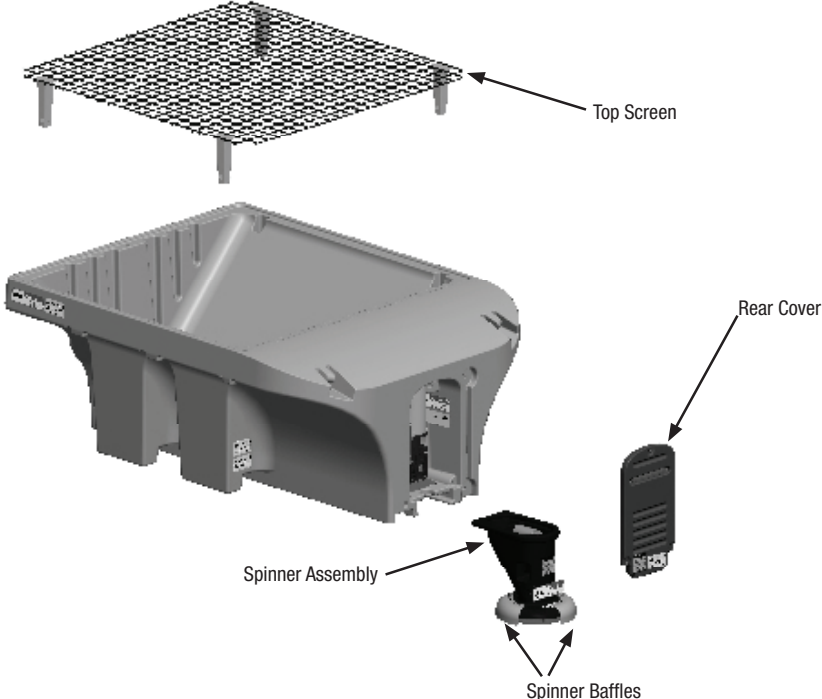

# Safety Definitions & Warnings

## SAFETY DEFINITIONS



This is the safety alert symbol. It is used to alert you to potential personal injury hazards. Obey all safety messages that follow this symbol to avoid possible injury or death.



**DANGER** Indicates an imminently hazardous situation which, if not avoided, will result in death or serious injury.

















**WARNING** Indicates a potentially hazardous situation which, if not avoided, could result in death or serious injury.



**CAUTION** Indicates an potentially hazardous situation which, if not avoided, may result in minor or moderate injury.















**CAUTION** used without the safety alert symbol indicates a potentially hazardous situation which, if not avoided, will result in property damage.

1		NEVER stand or ride on the spreader. Failure to comply will result in death or serious injury.
2		Keep hands, feet, and clothing away from power driven parts. Failure to comply will result in death or serious injury.
3		Make sure spreader is completely shut off and all movement has stopped before attempting to clean, service or unclog. Failure to comply will result in death or serious injury.
4		NEVER enter hopper while spreader is operating or capable of being operated. Failure to comply will result in death or serious injury.
5		NEVER operate or service your spreader without first CAREFULLY reading the Owner's Manual. It is CRITICAL for your safety to ALWAYS obey EVERY warning in the manual and follow EVERY instruction EXPLICITLY. Failure to comply could result in death or serious injury.
6		Never leave operator's position without first completely turning off spreader, disengaging PTO, shutting off hydraulic valve and setting vehicle parking brake. Failure to comply will result in death or serious injury.
7		Never operate spreader without all shields, guards, and safety decals in place. Failure to comply will result in death or serious injury.
8		Spreader should only be operated by personnel trained in the safe use and transportation of this equipment.
9		The spreader should NEVER be used for any other purpose other than spreading ice melting or traction products on streets, parking lots and driveways. Failure to comply will result in property damage, death or serious injury.
10		Inspect spreader assembly and mounting components and fasteners for wear and damage before and after each use. Worn or damaged components or fasteners could allow spreader to break free from the transport vehicle. Failure to comply will result in death or serious injury.
11		Transport vehicle must not be operated when overloaded. In all cases, the loaded vehicle weight, including the entire spreader system, all aftermarket accessories, driver, passenger, options, nominal fluid levels, and cargo must not exceed the front/rear Gross Axle Weight Rating (GAWR), and total Gross Vehicle Weight Rating (GVWR). These weights ratings are specified on the safety compliance certification label on the driver's side door opening. Failure to comply will result in death or serious injury.
12		Spreader may tip over or fall. Spreader should be solidly supported when being mounted, dismounted, moved, or stored. Failure to comply will result in death or serious injury.
13		Operator, bystanders and pets should be kept at least 50 (15m) feet away from spreader during operation. Failure to comply will result in death or serious injury.
14		SAFETY PRECAUTIONS should be used when hydraulic system is operating or being serviced. Hydraulic fluid under pressure can cause a skin injection injury. If you are injured by hydraulic fluid, get medical attention immediately. Failure to comply will result in death or serious injury.
15		Engine exhaust contains lethal fumes. Breathing these fumes, even in low concentrations, can cause death. Never operate engine in an enclosed area without venting the exhaust to the outside. Failure to comply will result in death or serious injury.



# Safety Definitions & Warnings

16		Gasoline is highly flammable and gasoline vapor is explosive. Never smoke while working on vehicle or spreader. Keep all open flames away from gasoline tank and lines. Wipe up any spilled gasoline immediately. Failure to comply will result in death or serious injury.
17		NEVER operate the spreader without first CAREFULLY reading the Owner's Manual. It is CRITICAL for your safety to ALWAYS obey EVERY warning in the manual and follow EVERY instruction EXPLICITLY. Failure to comply will result in death or serious injury.
18		A driver's first responsibility is the safe operation of the vehicle and spreader. The most important thing you can do to prevent a crash is to avoid distractions and pay attention to the road. Wait until it is safe to operate mobile communication equipment such as cell phones, two way radios, etc. Failure to comply will result in injury.
19		Vehicle must conform to all local, state, and national regulations regarding the use of reflective markings and flashing lights. Failure to comply will result in injury.
20		Batteries normally produce explosive gases which can cause personnel injury. Therefore, do not allow flames, sparks or lit tobacco to come near the battery. When charging or working near a battery, always cover your face and protect your eyes, and also provide ventilation. Batteries contain sulfuric acid which burns skin, eyes, and clothing. Failure to comply will result in injury.
21		Never transport spreader with spinner in the raised position. Failure to comply will result in property damage.
22		Installation of a Meyer spreader may affect your new vehicle warranty. Before beginning spreader installation verify mounting method is acceptable to your vehicle manufacturer. Failure to comply will result in property damage.
23		Warranty does not apply to a Meyer spreader product which has been negligently or improperly assembled or installed. Failure to comply will result in property damage.
24		CAUTION: To avoid harm to vehicles electrical system always disconnect battery before beginning installation. DO NOT BURN holes or WELD vehicle frame. This may cause frame failure. Failure to comply will result in property damage.
25		CAUTION: To avoid harm to spreader electrical system always disconnect battery before beginning installation or service. Do not operate spreader with a missing, discharged or dead battery. Failure to comply will result in property damage.
26		The Meyer spreader electrical system contains several automotive style fuses. If a problem should occur and fuse replacement is necessary, the replacement fuse must be of the same type and amperage as the original. Installing a fuse with a higher rating can damage the system and could cause a fire. Failure to comply will result in property damage.
27		Spreader is not designed to be chassis mounted. Do not support spreader by body jacks alone. Spreader must be installed directly onto truck bed. Failure to comply will result in property damage.

## SAFETY DEFINITIONS



This is the safety alert symbol. It is used to alert you to potential personal injury hazards. Obey all safety messages that follow this symbol to avoid possible injury or death.



DANGER Indicates an imminently hazardous situation which, if not avoided, will result in death or serious injury.



WARNING Indicates a potentially hazardous situation which, if not avoided, could result in death or serious injury.



CAUTION Indicates a potentially hazardous situation which, if not avoided, may result in minor or moderate injury.



CAUTION used without the safety alert symbol indicates a potentially hazardous situation which, if not avoided, will result in property damage.

# Safety Decals

These safety alert decals are used to alert you of potential personal injury hazards. Obey all safety messages that follow this symbol to avoid possible injury or death.



**DANGER Conveyor**  
This decal alerts all to the danger of serious personal injury or death while servicing or cleaning this equipment without first turning off or disconnecting all power sources.



**DANGER Spinner**  
This decal alerts all to the danger of any person being near the spinner while it is turning where serious personal injury could result if struck by flying debris.



**CAUTION**  
This decal cautions all to the risk of the tank containing hazardous chemicals. Operators should wear appropriate PPE when contact with chemicals is possible.



**CAUTION**  
This decal cautions all to observe general safety procedures when operating, moving, storing, cleaning or servicing this equipment.



**CAUTION Empty Hopper**  
This decal cautions all to only lift or move equipment when hopper is empty to prevent the risk of serious personal injury or property damage.



**CAUTION Fork Length**  
This decal cautions all to make sure fork lift arms extend a minimum of 4" (10.2cm) past both brackets before lifting or moving equipment to prevent the risk of serious personal injury or property damage.

# Safety Decal Locations

**DANGER Conveyor** decal alerts all to the danger of serious personal injury or death while servicing or cleaning this equipment without first turning off or disconnecting all power sources.

**DANGER Spinner** decal alerts all to the danger of any person being near the spinner while it is turning where serious personal injury could result if struck by flying debris.

**CAUTION** decal cautions all to observe general safety procedures when operating, moving, storing, cleaning or servicing this equipment.

**CAUTION Empty Hopper** decal cautions all to only lift or move equipment when hopper is empty to prevent the risk of serious personal injury or property damage.

**CAUTION Fork Length** decal cautions all to make sure fork lift arms extend a minimum of 4" past both brackets before lifting or moving equipment to prevent the risk of serious personal injury or property damage.

**CAUTION Hazardous Material** decal cautions all to the possibility the tank may contain hazardous material. Proper PPE should be worn at all times while working with hazardous chemicals.

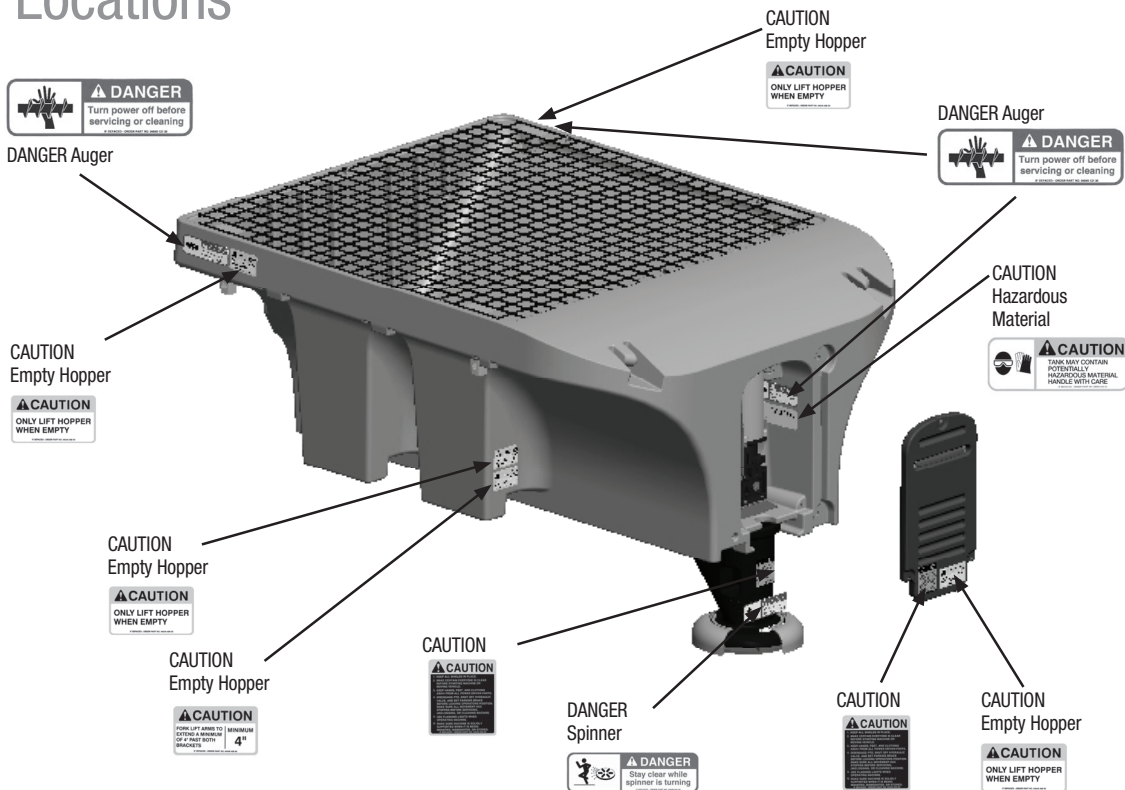

# Component Identification

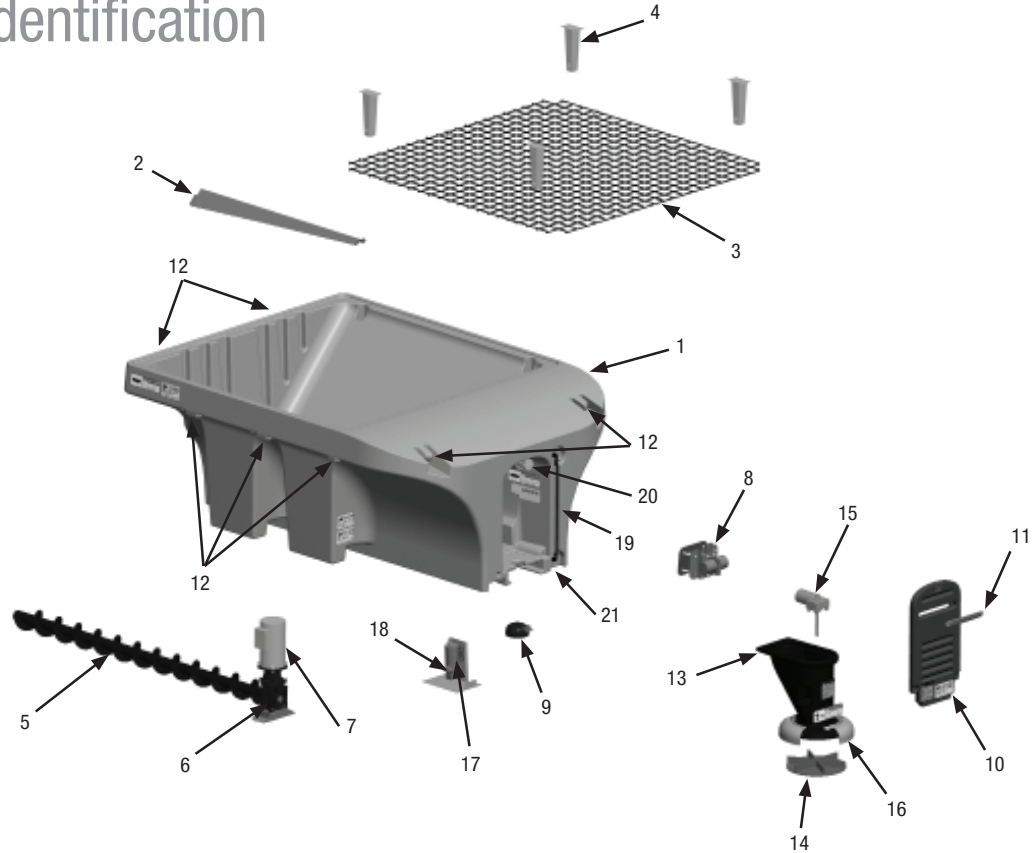

# Component Identification

1. **Hopper** – Molded poly hopper holds spreading material and pre-wet liquid.
2. **Inverted Vee** – Relieves weight of material on the auger.
3. **Top Screen** – Breaks up large clumps of material and prevents foreign objects from entering hopper.
4. **Screen Stakes** – Secures screen to the hopper and is also the attachment point for the hold down straps or chains.
5. **Auger** – Is driven by the gearbox and moves material out of hopper to the spinner assembly.
6. **Gearbox** – Receives power from the electric motor and rotates the auger.
7. **Electric Motor**– Supplies power to the gearbox to drive the auger.
8. **Vibrator** – Breaks up material clumps and allows material to free flow to the auger.
9. **Work Light** – Allows operator to see material being spread while operating at night.
10. **Rear Cover** – Covers control system and drive parts to keep out moisture and prevents access to moving auger.
11. **CHMSL** – Complies with Federal Motor Vehicle Safety Standards.
12. **Tarp Hooks** - Provides location to attach tarp to hopper.
13. **Spinner Assembly** – Attaches to the rear of the spreader and distributes the spreading material onto road the surface.
14. **Spinner Disc** – Rotates at a high RPM and throws material out of the spinner assembly.
15. **Spinner Motor** – Supplies power to drive the spinner disc.
16. **External Baffles** – Adjusts the width of the spread pattern behind the vehicle.
17. **Pre-wet Pump** - pumps liquid to spray nozzle located on the spinner assembly.
18. **Liquid Strainer** - filters solids and debris from pre-wet liquid to prevent clogging spray nozzle.
19. **Sight Gauge** - Allows operator to visually check level of pre-wet liquid inside hopper.
20. **Fill Port** - Allows hopper to be filled with pre-wet liquid.
21. **Liquid Drain** - Allows pre-wet liquid to be drained from hopper.

# Vehicle Loading

## Determining Vehicle Payload

It is necessary to calculate the available material payload to prevent overloading the vehicle. Overloading the vehicle can create dangerous stability and braking problems. Always consult and follow vehicle manufacturer's weight ratings and mounting instructions.

1. Mount complete spreader and any optional equipment on vehicle.
2. Attach all additional equipment onto vehicle such as snow plow, hitch, etc that will be used when spreader is mounted on vehicle.
3. Fill fuel tanks.
4. With normal operator(s) inside of vehicle, weigh vehicle to obtain the Gross Vehicle Weight (GVW).
5. Obtain Gross Vehicle Weight Rating (GVWR), Front Gross Axle Weight Rating (FGAWR), and Rear Gross Axle Weight Rating (RGAWR) from the driver's door jam or from the vehicle manufacturer.
6. Subtract the GVW from the GVWR to obtain the available material payload.
7. Divide the payload by the material density (see Material Density Chart) to determine the maximum volume of material that can be carried by the vehicle.
8. Refer to Spreader Capacity Chart to determine the recommended level to fill hopper to obtain desired payload.
9. Load spreader with material to the calculated height.
10. Weigh vehicle to verify vehicle does not exceed GVWR, FGAWR, or RGAWR.
11. Repeat procedure for each type of spreading material to be used.

Note: Material weights shown in Material Density Chart are *average* material weights. Actual weight of materials may vary depending on vendor and the geographic area the materials are obtained from.

Material Capacity

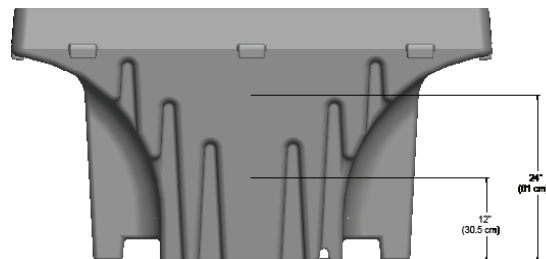

Liquid Capacity

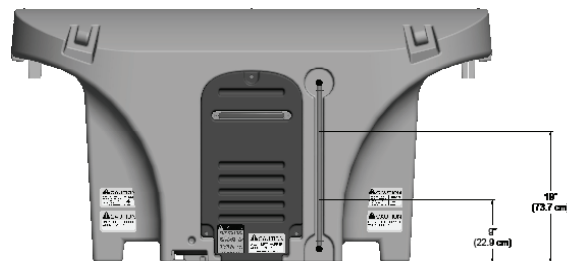

# Vehicle Loading

## Spreader Capacity

### Granular Volume at Specified Height (Cu. Yds.)

Spreader	Full	24"	12"
6'	1.50	0.61	0.11
8'	2.00	0.84	0.15

### Liquid Volume at Specified Height (Gallons)

Spreader	Full	19"	9"
6'	175	149	80
8'	225	196	107

### Granular Volume at Specified Height (M3)

Spreader	Full	24"	12"
6'	1.15	0.47	0.08
8'	1.53	0.64	0.11

### Liquid Volume at Specified Height (Liters)

Spreader	Full	19"	9"
6'	663	564	303
8'	852	742	405

### Side Extension Granular Capacity

Spreader	Cu. Yds.	M3
6'	0.59	0.45
8'	0.83	0.63

## Material Density

Granular	Density	
	lbs. per cubic yard	kg per M3
Coarse Salt - Dry	2,052	932
Coarse Sand - Dry	2,700	1,227
Coarse Sand - Wet	3,240	1,472
Liquid	Density	
	lbs. per gallon	kg per liter
Sodium Chloride	9.80	4.44
Magnesium Chloride	10.75	4.88
Calcium Chloride	10.85	4.92

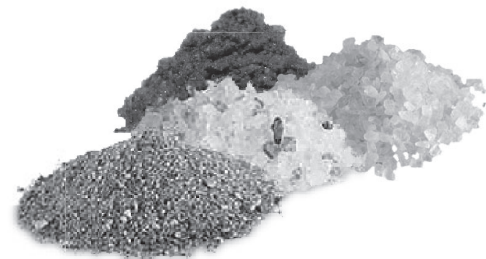

# Installation / Assembly Instructions

Option 1: Ratchet straps installed on each corner of the spreader at opposing

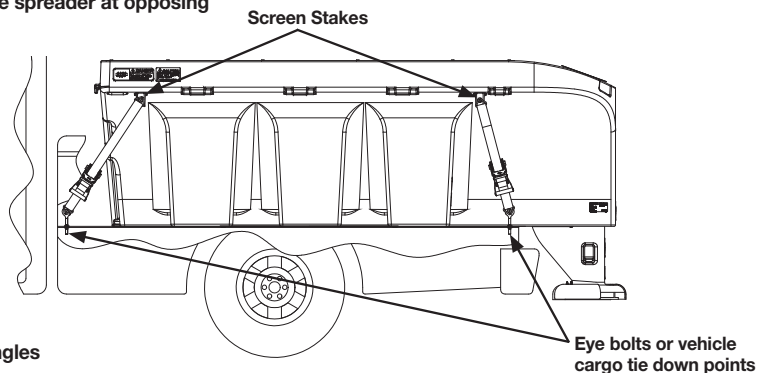

Option 2: Ratchet straps criss- crossed at opposing angles

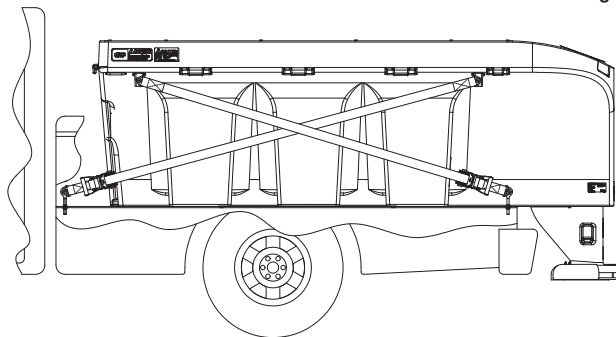



# Installation / Assembly Instructions

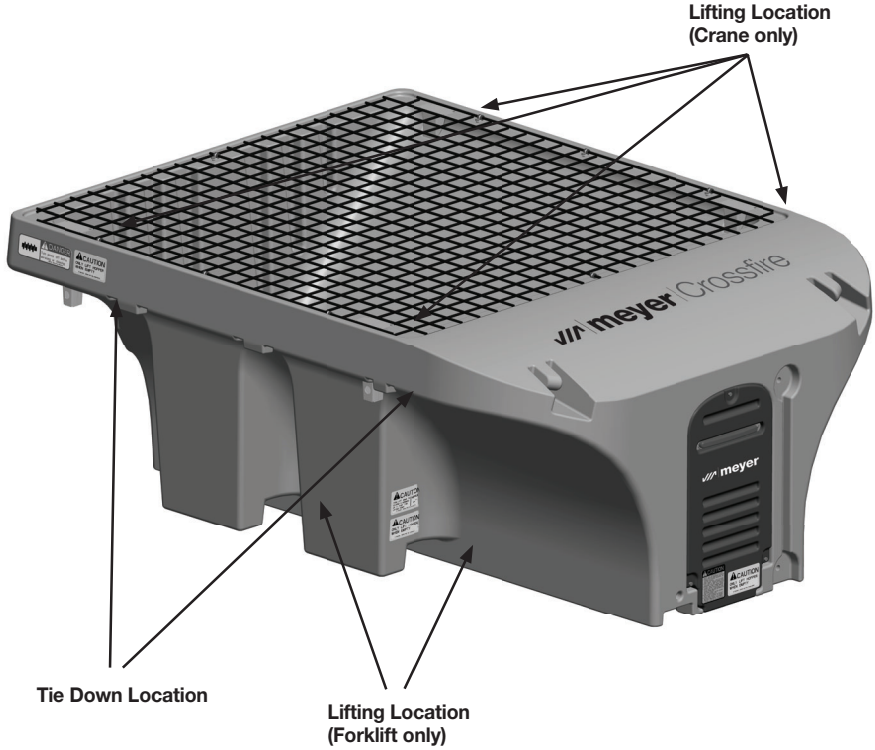

SAFETY PRECAUTIONS  
SEE PAGES 8-9 FOR DEFINITIONS

**⚠ DANGER** 1, 2, 3, 4

**⚠ WARNING** 5, 6, 7, 8, 9, 11, 12

**⚠ CAUTION** 19

**⚠ CAUTION** 22, 23, 24, 25, 27

# Installation / Assembly Instructions

## Vehicle Preparation

Overloading vehicle can create dangerous stability and braking problems. Always consult and follow vehicle manufacturers weight ratings and mounting instructions.

1. Turn off vehicle engine, set parking brake, and remove keys.
2. Remove tailgate from vehicle.
3. Remove trailer hitch if equipped.

## Spreader Preparation

1. Remove all loose items from inside of hopper such as the spinner assembly, controller, etc.
2. Make sure hopper is completely empty before attempting to lift or move spreader.

## Lifting Spreader

All chains, hooks, and straps must be of an adequate weight rating to support entire spreader including any additional or optional equipment that may be installed. Never attempt to lift or move a spreader with material in the hopper.

1. Forklift Pockets: The Crossfire spreader can be lifted with a forklift by utilizing the rear forklift pockets. Extended forks are recommended for use with the forklift pockets. Verify forklift is of an adequate weight rating to prevent forklift from tipping while moving spreader.
2. Spreader can be lifted by removing the screen stakes and attaching a lifting strap to through each screen stake pocket in a choker configuration.

## Spreader Installation

The Crossfire spreader should be mounted directly on the vehicle bed, spreader is not designed to be supported by body jacks alone or for chassis mount applications. Shipping skid is intended to be removed before mounting spreader. Verify mounting method is acceptable to the vehicle manufacturer before attempting to mount spreader.

1. Place spreader directly onto bed of vehicle with discharge at the rear of the vehicle.
2. Spreader is designed sit directly on vehicle bed. Do not support spreader by body jacks alone. Spreader is not designed to be chassis mounted.
3. Attach spinner assembly to spreader. Make sure spreader cannot tip when spinner assembly is installed (see spinner assembly installation instructions).
4. Reposition spreader on vehicle bed, just short of the spinner assembly making contact with the rear most part of the bed, bumper, pintle hook, etc.
5. Adequate tie down locations are necessary for proper installation of the Crossfire spreader. Vehicle should be equipped with cargo tie down brackets in each corner of bed. If vehicle is not equipped cargo tie down brackets, a minimum of four 1/2" eye bolts or d-rings will need to be added to vehicle bed.
6. Install one ratchet strap from each corner of vehicle bed to appropriate spreader tie down location. Straps should be installed at opposing angles to prevent spreader from sliding in vehicle bed.

# Installation / Assembly Instructions

*The Crossfire spreader can be mounted and stored as a single unit. The Crossfire spreader will mount on most medium or heavy duty pickup trucks. The Crossfire spreader can be mounted on 3/4 ton or larger trucks, but may require optional extended spinner.*

## Spinner Assembly Installation

Spinner should be solidly supported during installation. Spinner assembly weighs over 50 lbs. (22.7 kg) and may require more than one person for safe installation.

1. Remove three 1/4" bolts and remove rear cover from spreader. CHMSL will need to be disconnected to fully remove Rear Cover.
2. Align top flange of spinner assembly with the slots in the hopper. Slide spinner into hopper until fully engaged in slots.
3. Connect spinner harness to appropriate harness from control system.
4. Reconnect CHMSL, reinstall rear cover onto spreader and secure with 1/4" bolts.

## Center High Mount Stop Lamp Installation (CHMSL)

Federal Motor Vehicle Safety Standards require all trucks, buses, and multipurpose passenger vehicles manufactured on or after 5/1/1993, with a gross vehicle weight rating (GVWR) of 10,000 LBS. or less and an overall width less than 80" be equipped with a center high mount stop lamp (CHMSL). If the original vehicle CHMSL is obscured, an auxiliary CHMSL must be installed to bring the vehicle back into compliance with Federal Regulations. Spreader is furnished with an auxiliary CHMSL and wire harnesses for connection to vehicle electrical system. Consult vehicle manufacturer's recommendations for approved method of connecting CHMSL to vehicle. Refer to the Wire Schematic section in this manual for additional information.

# Controller Harness

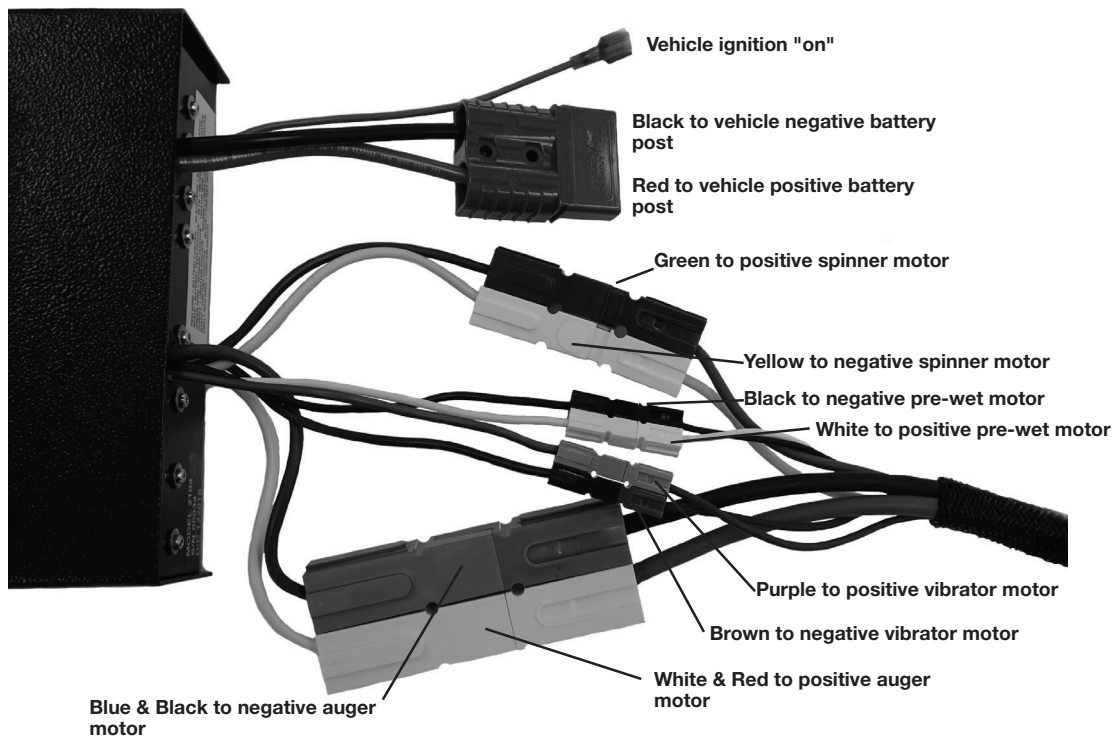

# Brake Light & Work Light Harnesses

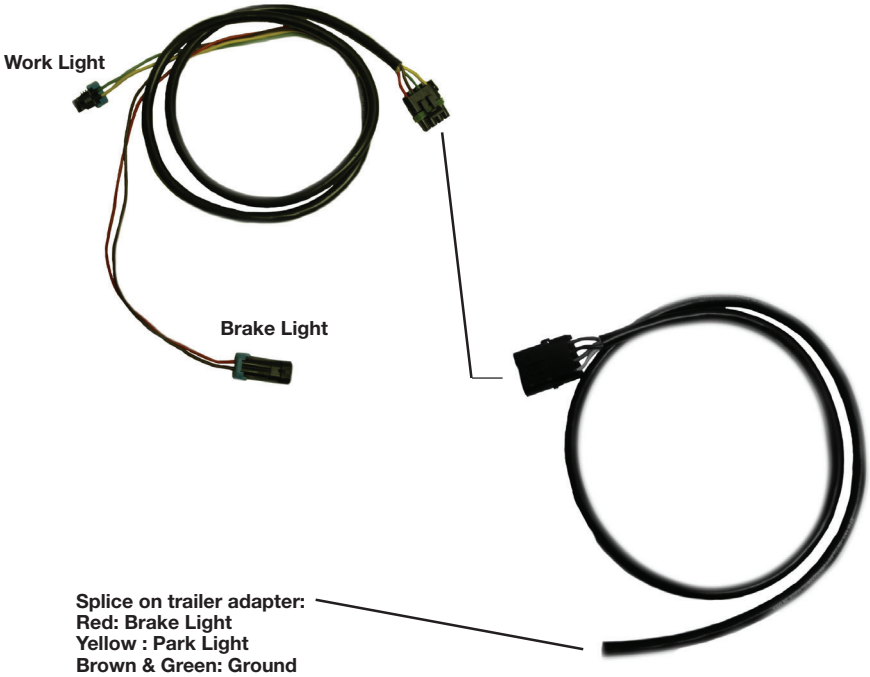

# Standard Spreader Controller



# Standard Plus Spreader Controller



# Controller

The Standard and Standard Plus Spreader Controller is intended to control the following functions of the spreader: auger feed rate, spinner speed, liquid flow rate, blast, and vibrate. The control system is overload protected and utilizes an auto reverse feature when jams are encountered.

**OVERVIEW** The standard spreader control system offers independent output control for the auger rate and spinner rate. The standard plus spreader control system offers independent output control for the auger rate, spinner rate, and pre-wet flow.

**OPERATION** The vehicle ignition must be turned on in order for the controller to operate. When the ON/OFF switch is in the "OFF" position, the controller has no functions and the spreader will not operate. When ON/OFF switch is in the "ON" position, the spreader functions are able to be used and the spreader can be operated. Be sure to turn off the spreader controller before turning the vehicle ignition off.

**BLAST FEATURE** When the blast feature is activated the auger, spinner, and pre-wet functions will automatically operate at setting "10" regardless of where they were set before the blast mode was activated. Once the blast mode is deactivated the auger, spinner, and pre-wet functions will return to their previous settings.

**VARIABLE SPEED SETTINGS** The controller is equipped with two (standard) or three (standard plus) variable speed functions, one each for the auger feed rate, spinner speed rate, and pre-wet flow (standard plus) rate. Variable speed functions have settings of 0 -10 with setting 10 being full output. The variable speed settings can be changed by turning the AUGER, SPINNER, or LIQUID "clockwise" to increase the output, and "counter clockwise" to decrease the output. Each variable speed function has 10 number settings to provide a visual indication of the current setting. Variable speed settings will not operate at setting "0". spreader. Any time the variable speed setting is at any setting higher than "0" the auger, spinner, or pre-wet function is capable of operating.

**VIBRATOR** The spreader mounted vibrator can be activated by pressing the Vibrator button.

**ERROR LIGHT/FLASH NUMBER LIGHT** The error light will illuminate along with the flash number light when the spreader encounters a problem. The flash number light will begin to flash on and off. Count the number of flashes which will correspond to the spreader issue.

**1 Flash** Low vehicle battery voltage

**2 Flashes** Blown controller fuse

**3 Flashes** Disconnected Motor

**4 Flashes** Spinner overload

**5 Flashes** Auger overload

**6 Flashes** External Short

**7 Flashes** No vehicle battery voltage

**When a jam is encountered** the auger will reverse for 3 seconds and then resume in the normal direction. If the jam is encountered again it will reverse for 2 more cycles and if not cleared it will not operate the spreader at all. The power will need to be disconnected from the spreader and the jam will need to be manually cleared. Once the jam is cleared reconnect the power to the spreader and cycle the on/off switch. The controller will now operate.

# Operating Instructions

## Filling Hopper

The hopper should only be filled with clean, dry, free flowing salt. Commercial bagged ice melt materials may be used. Spreader is not designed to spread sand, ag lime, gravel, rock, cinders, or any other aggregate materials. Only fill the hopper with the top screen installed to prevent foreign objects or frozen clumps of material from entering the hopper and damaging the conveyor system. Do not leave unused material inside of hopper when not in use. Do not let material freeze inside of hopper.

**Gearbox:** Never apply torque to output shaft of gearbox. Gearbox is designed to only accept torque from the input shaft.

## Regulating amount of material being spread

The amount of material being spread depends upon the auger speed. Increasing the auger speed will increase the amount of material being spread. Decreasing the auger speed will decrease the amount of material being spread.

The auger speed can be adjusted on the deluxe spreader controller by pressing the AUGER UP or DOWN buttons until the desired speed is achieved.

The auger speed can be adjusted on the standard spreader controller by turning the AUGER knob left or right until the desired auger speed is achieved.

## Regulating the spread pattern

The spread pattern is the width and direction of material being spread. The width of the spread pattern can be regulated by increasing or decreasing the spinner disc speed. Increasing the spinner disc speed will increase the spread width. Decreasing the spinner disc speed will decrease the spread width. The direction of the spread pattern can be regulated by adjusting the external baffles on the spinner assembly.

The spinner speed can be adjusted on the standard and standard plus spreader controller by turning the SPINNER knob left or right until the desired speed is achieved.

## Noise & Vibration Reduction

1. Keep all mechanical fasteners and guards tight and in their proper location.
2. Periodically clean built-up material from spinner disc.
3. Use optional hopper vibrator only as needed.
4. Only spread clean material free of debris such as rocks, wood, asphalt, etc.



# Operating Instructions

## Adjusting external spinner baffles:

1. Loosen wing both wing nuts on each spinner baffle.
2. Slide spinner baffles in or out to desired position.
3. Tighten wing nuts on both spinner baffles.

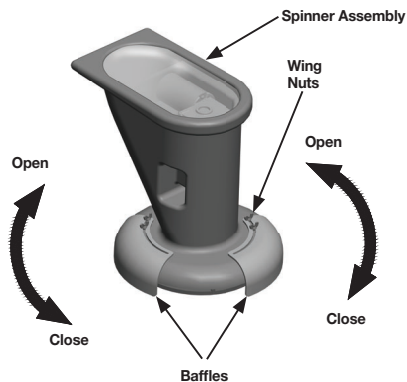

DESIRED SPREAD PATTERN	BAFFLE SETTING	
	LEFT	RIGHT
LEFT & RIGHT	OPEN	OPEN
LEFT	OPEN	CLOSED
RIGHT	CLOSED	OPEN
CENTER WINDROW	CLOSED	CLOSED

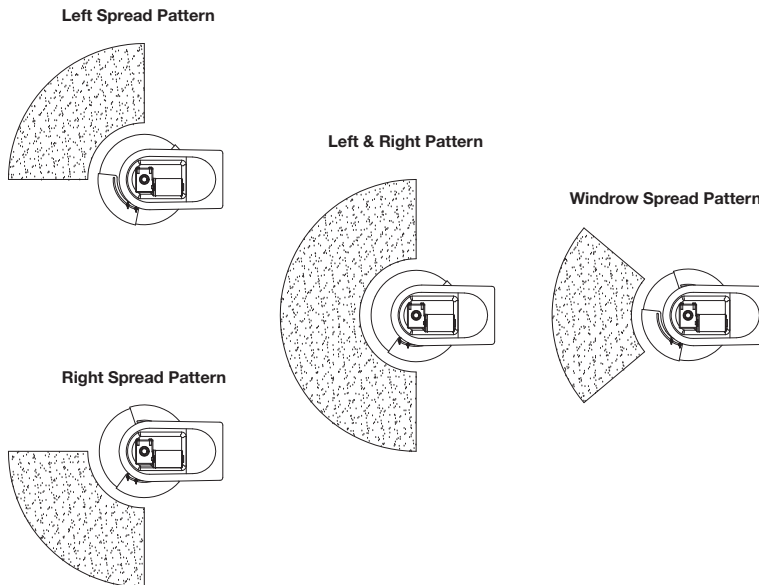

# Pre-Season Maintenance

*Regular maintenance is the key to your Meyer Spreader operating efficiently and trouble free. Meyer Products LLC recommends this maintenance information for regular service. Sustained heavy operation may call for more frequent service. Material spreading subjects a vehicle to exceptionally rugged use. As a result, it is very important to inspect and bring the spreader and vehicle up to maximum operating conditions. Inspection should be made of both the vehicle and spreader prior to the winter season and each use.*

## Vehicle Maintenance

Don't forget that in addition to keeping equipment in order:

1. Keep windshield wipers, heaters and lights working.
2. Use emergency flashing lights for increased visibility and safety.
3. Equip vehicle with tire chains when necessary.
4. Provide operators with protective clothing and gloves for handling ice melting chemicals.

## Vehicle Electrical System

For maximum efficiency, the vehicle supporting the spreader must be properly serviced. The system should consist of at least a 70 amp/hr battery and a 60 amp alternator. Be sure to check regularly:

1. Battery terminals to assure they're tight and free of corrosion.
2. Electrical connections, to assure they're tight and corrosion free.
3. Battery must be in top operating condition.
4. Alternator and regulator, to assure maximum electrical output.

## Spreader

Prior to the start of the winter season the pre-season maintenance should be performed to ensure the spreader operates reliably. Follow the maintenance schedule for service recommendations. Don't forget to also do the following:

1. Verify spreader is securely attached to vehicle.
2. Inspect Spreader for loose, missing, or damaged parts, guards, or hardware.
3. Repaint any rusty parts.
4. Ensure moving parts are free and not corroded.
5. Test run spreader before filling with material.

# General & Post Season Maintenance

## General Maintenance

**Inspection:** Before and after each use, spreader should be inspected for loose, missing, or damaged mounting hardware, parts, or safety guards. Spreader should also be inspected to ensure it is securely attached to the vehicle.

**Cleaning:** Empty all material from spreader after each snow or ice event. Wash entire spreader with soap and warm water. Do not clean spreader with any corrosive chemicals or products that contain chlorides or ammonium. Any commercially available salt neutralizer may be applied.

**Gearbox:** Both the auger and spinner gear reducers are permanently sealed for life and do not require lubrication.

**Electrical System:** Electrical system should be inspected for loose connections and corrosion every 10 hours of operation or weekly. Dielectric grease should be applied to all electrical connections.

## Post Season Maintenance

At the end of the winter season, perform the post-season maintenance as listed in the maintenance service schedule to prevent costly repairs at the start of the next season. Also don't forget to:

1. Empty and thoroughly wash entire spreader with warm soap and water.
2. Apply dielectric grease to all electrical connections and install connector covers to prevent corrosion.
3. Oil or paint any rusty parts or surfaces.

## Maintenance Service Schedule

MAINTENANCE TASK TO BE COMPLETED	Pre-Season	Daily	10 Hours or Weekly	Post-Season
Inspect spreader for loose, missing, or damaged parts or hardware	X	X		X
Verify spreader is securely attached to vehicle	X	X		
Inspect electrical connections and apply dielectric grease to connections	X		X	X
Oil or paint rusty surfaces	X			X

# Troubleshooting

Condition	Possible Cause	Correction
Auger will not operate	Controller not functioning properly	See controller troubleshooting
	Auger jammed by a foreign object, or frozen material	Inspect auger for obstruction and remove
	Damaged gearbox	Inspect and repair gearbox
	Shaft key missing from auger motor	Inspect for missing key and replace
Auger operates erratically	Shaft key missing from auger motor	Inspect for missing key and replace
	Material "bridged over" in hopper	Replace with clean, dry, free flowing material
Noisy operation	Loose or damaged auger	Adjust or replace auger
	Foreign object in auger	Remove object
	Spinner disc unbalanced	Remove material from spinner disc
Material not exiting discharge chute	Auger discharge clogged	Clear material from discharge
	Material "bridging" inside hopper	Use free flowing material
	Inverted Vee not installed	Install inverted Vee
Material leaking from hopper	Material too fine	Use a coarser material
Spinner disc not turning	Spinner disc jammed	Clear jam from spinner disc
	Shaft roll pin missing	Inspect and replace roll pin

# Troubleshooting

Condition	Possible Cause	Correction
Controller has no power	Controller not turned ON	Move on/off switch to on
	Power supply harness connections loose or corroded	Clean and tighten power supply harness connections
	Controller internal fuse blown	Replace internal fuse
Controller has power but auger does not operate	Auger harness is not connected to controller	Connect auger harness to controller
	Auger harness connection at rear bumper is loose or corroded	Clean and reconnect auger harness connections
	Auger harness connections at electric motor are loose or corroded	Clean and tighten auger harness connections
	Auger speed setting is set too low	Adjust auger speed to a higher setting
	Controller internal fuse blown	Replace fuse
	Auger harness damaged	Replace auger harness
Controller has power but spinner does not operate	Spinner harness is not connected to controller	Connect spinner harness to controller
	Spinner harness connection at rear bumper is loose or corroded	Clean and reconnect spinner harness connection
	Spinner harness connections at electric motor are loose or corroded	Tighten or replace spinner harness wire nuts
	Spinner speed setting is set too low	Adjust Spinner speed to a higher setting
	Controller internal fuse blown	Replace fuse
	Spinner harness damaged	Replace spinner harness
Auger operates erratically	Loose or corroded auger harness connections	Clean and tighten harness connections
	Auger speed setting is set too low	Adjust auger speed to a higher setting
	Defective electric motor	Replace electric motor
	Auger harness damaged	Replace auger harness

# Spreader Calibration

## LANE MILE CALIBRATION (US)

DISCHARGE RATE (pounds discharged per mile)

Control Setting	A	B	C	TRAVEL SPEED AND COMPUTATION MULTIPLIER								
	Shaft RPM (Loaded)	Discharge per Revolution (lbs.)	Discharge per Minute (lb) (A x B)	5 mph (C x 12.00)	10 mph (C x 6.00)	15 mph (C x 4.00)	20 mph (C x 3.00)	25 mph (C x 2.40)	30 mph (C x 2.00)	35 mph (C x 1.71)	40 mph (C x 1.50)	45 mph (C x 1.33)
1												
2												
3												
4												
5												
6												
7												
8												
9												
10												

The actual application rate (*lbs. per lane mile*) on the highway is the discharge rate divided by the number of lanes being treated.

### Spreader Calibration Procedure

Calibration is simply calculating the pounds per mile discharged for each control setting at various travel speeds by first counting the number of auger or conveyor shaft revolutions per minute, measuring the weight of salt discharged in one revolution, then multiply the two to obtain discharge per minute, and finally multiplying the discharge per minute by the time it takes to travel 1 mile.

### Equipment needed:

1. Scale to weigh salt
2. Salt collection device
3. Marking device
4. Watch with second hand

### Calibration steps:

1. Remove spinner assembly.
2. Put partial load of salt in spreader.
3. Mark shaft end of auger.
4. Count number of shaft revolutions per minute at each spreader control setting, record.
5. Collect salt discharged for one revolution, weigh it and deduct the weight of the container. (For greater accuracy, collect salt for several revolutions and divide by that number of revolutions to get the weight for one revolution.)

# Spreader Calibration

## PARKING LOT CALIBRATION (US)

DISCHARGE RATE (pounds discharged per square foot)

	A	B	C	D	E	F	G	H	I	(lbs. discharged per sq. ft.)			
Control Setting	Shaft RPM (Loaded)	Spread Pattern width (ft.)	Spread Pattern sq. ft. (.5 x B) x (.5 x B) x (3.14)/2	Discharge per Auger Revolution (lbs.)	Discharge per Minute (lb) (A x C)	5 mph (D x 12.00)	10 mph (D x 6.00)	15 mph (D x 4.00)	20 mph (D x 3.00)	5 mph F/(C x 5280)	10 mph G/(C x 5280)	15 mph H/(C x 5280)	20 mph I/(C x 5280)
1													
2													
3													
4													
5													
6													
7													
8													
9													
10													

The actual application rate (lbs. per sq. ft.) on the parking lot.

### Spreader Calibration Procedure

Calibration is simply calculating the pounds per mile discharged for each control setting at various travel speeds by first counting the number of auger or conveyor shaft revolutions per minute, measuring the weight of salt discharged in one revolution, then multiply the two to obtain discharge per minute, and finally multiplying the discharge per minute by the time it takes to travel 1 mile.

### Equipment needed:

1. Scale to weigh salt
2. Salt collection device
3. Marking device
4. Watch with second hand

### Calibration steps:

1. Remove spinner assembly.
2. Put partial load of salt in spreader.
3. Mark shaft end of auger.
4. Count number of shaft revolutions per minute at each spreader control setting, record.
5. Collect salt discharged for one revolution, weigh it and deduct the weight of the container. (For greater accuracy, collect salt for several revolutions and divide by that number of revolutions to get the weight for one revolution.)

# Warranty

**What is Covered:** Meyer® Products, LLC, warrants to the original purchaser of Meyer brand products that they will be free from defects in materials or workmanship, with the exceptions stated below. No person is authorized to change this warranty or to create any additional warranty on Meyer products.

**How Long Coverage Lasts:** This warranty runs for a period of two years from the date of purchase on any purchase of a complete Crossfire Spreader Package. If the Package is registered on-line at [www.meyerproducts.com](http://www.meyerproducts.com) within sixty (60) days of purchase, your warranty for the Package will be extended for a period of three years. All foregoing warranties apply only to an original purchaser of the product if the product is installed by an authorized Distributor/Sub-Distributor and terminate if the product is sold or otherwise transferred. Some states do not allow limitations on how long an implied warranty lasts, so the above limitation may not apply to you.

**What is Not Covered:** This warranty does not cover:

- Problems caused by failure to follow the product instructions, failure to maintain the product as described in the Owner's Manual;
- Problems caused by contamination or damage resulting from rust, corrosion, freezing or overheating;
- Paint, or expendable spreader parts such as Auger or Spinner
- Damage to any vehicle to which the products are mounted;
- Damage caused by usage that is not in accordance with product instructions (use of the spreader for any purpose other than spreading salt/sand is considered misuse and abuse);
- Any spreader, or any part, component, or assembly thereof, which has been modified or altered;
- Problems caused by using accessories, parts, or components not supplied by Meyer Products;
- Cost of tax, freight, transportation or storage charges, environmental charges, solvents, sealants, lubricants or any other normal shop supplies.
- Problems caused by collision, fire, theft, vandalism, riot, explosion, lightning, earthquake, windstorm, hail, water, flood, or any other Acts of God;
- Liability for damage to property, or injury to, or death of any person arising out of the operation, maintenance or use of the covered product;
- Products with missing or altered serial numbers;



# Warranty

The original purchaser's sole and exclusive remedy against Meyer® Products and its Distributors and Sub-Distributors, and Meyer Products' sole obligation for any and all claims, whether for breach of contract, warranty, tort (including negligence) or otherwise shall be limited to providing, through its authorized Distributor/Sub-Distributor network, all labor and/or parts necessary to correct such defects free of charge. Any cost incurred in returning the product to an authorized Meyer Distributor/Sub-Distributor is the responsibility of the original purchaser. ALL EXPRESS AND IMPLIED WARRANTIES FOR THE PRODUCT, INCLUDING, WITHOUT LIMITATION, ANY IMPLIED WARRANTIES OF MERCHANTABILITY AND FITNESS FOR A PARTICULAR PURPOSE, ARE LIMITED IN TIME TO THE TERM OF THE LIMITED WARRANTY PERIOD. NO WARRANTIES, WHETHER EXPRESS OR IMPLIED, WILL APPLY AFTER THE LIMITED WARRANTY PERIOD HAS EXPIRED. Meyer Products disclaims liability beyond the remedies provided for in this limited warranty, and disclaims all liability for incidental, consequential, and special damages, including, without limitation, any liability for third-party claims against you for damages, for products not being available for use, or for lost profits. Meyer Products' liability will be no more than the amount you paid for the product that is the subject of a claim; this is the maximum amount for which we are responsible. Some states do not allow the exclusion or limitation of incidental or consequential damages, so the above limitation or exclusion may not apply to you. A complete Crossfire Spreader Package consists of the Spreader Assembly, operating controller and all related items.

**What Meyer Products Will Do:** Meyer Products will repair any product that proves to be defective in materials or workmanship. In the event repair is not possible or practical (as determined by Meyer Products in its sole discretion), Meyer Products will either replace the product with a new product of similar model and price, or refund the full purchase price, as determined by Meyer Products.

**Customer Responsibilities:** Customer must keep the complete Crossfire Spreader Package serviced/maintained as recommended by Meyer Products. A written record of service must be maintained, along with receipts for maintenance materials purchased. A copy of the maintenance record and pertinent receipts may be requested in the event of a claim.

**How To Get Service:** In order to obtain service under this warranty, the original purchaser must:

- Use all reasonable means to protect the complete Crossfire Spreader package from further damage;
- Return the claimed defective part to the Meyer or Aebi-Schmidt dealer from whom the product was purchased or to any authorized Meyer or Aebi-Schmidt dealer. Transportation and freight charges prepaid when applicable. Only Meyer or Aebi-Schmidt dealers are authorized to perform the obligations under this warranty. For the address and telephone number of the Meyer or Aebi-Schmidt dealer nearest you visit <https://www.meyerproducts.com/dealer-locator>;
- Provide maintenance record and receipts for required maintenance, if requested;
- Allow inspection of damaged parts and/or complete Crossfire Spreader package if deemed necessary by Meyer Products;
- It is the responsibility of the original purchaser to establish the warranty period by verifying the original delivery date. A bill of sale/sales receipt, cancelled check or some other appropriate payment record may be kept for that purpose.

**How State Law Applies:** This warranty gives you specific legal rights, and you may also have other rights which vary from state to state.

# Notes

# Notes

Meyer Products carries a full line of spreaders and other products including:



### Broadcast Spreaders

If you are looking for a heavy-duty broadcast spreader for all-season use,



### Insert Hopper

Featuring an unprecedented ten-year warranty on the virtually indestructible polyethylene hopper, Meyer outlasts virtually every hopper on the market.



### Tailgate Spreaders

With direct drive motors that help the auger to grind through large chunks of



### Dump Truck

Getting a good return on your dump truck is important. That's why we make the very best Under Tailgate Spreaders (UTG) and Replaceable Tailgate Spreaders (RTG) available.

Meyer Products LLC  
18513 Euclid Avenue  
Cleveland, OH 44112-1084  
216-486-1313  
[www.meyerproducts.com](http://www.meyerproducts.com)

Dealer Information: