



STARGUARD® 8-INCH ROUND MAIN DRAIN



Installation Guide

IMPORTANT SAFETY INSTRUCTIONS
READ AND FOLLOW ALL INSTRUCTIONS
SAVE THESE INSTRUCTIONS

Customer Service / Technical Support

Phone: 800.831.7133

8 AM to 7:30 PM

Fax: 805.284.4151

Web site: www.pentairpool.com

READ, THEN KEEP THESE INSTRUCTIONS FOR FUTURE REFERENCE

Contents

WARNINGS and IMPORTANT SAFETY PRECAUTIONS.....ii
 The Virginia Graeme Baker Pool and Spa Safety Actvi
 Acts Codes and Standards.....vii
 Hydraulic System Specifications.....1

Section 1

Field Fabricated Sump Installation.....3



Section 2

StarGuard® 8-inch Round Drain Installation4

P/N 500100 - 500109, 500140 - 500149



Section 3

StarGuard® 8-inch Round Drain Two Port (2" NPSM Side x 1-1/2" NPSM Bottom) Installation7

P/N 500110 - 500114



Section 4

StarGuard® 8-inch Round Drain Single Port (2" NPSM Side) Installation10

P/N 500115 - 500119

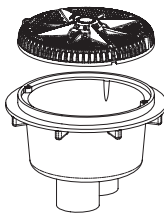

Section 5

StarGuard® 8-inch Round Drain (Dual Bottom Ports) Installation13

P/N 500120 - 500129



Section 6

StarGuard® 8-inch Round Drain Two Port (for vinyl liner pools) (2" NPSC Side x 1-1/2" NPSC Bottom) Installation17

P/N 500130 - 500139

Required tools: No. 2 Philips head screwdriver and torque driver (in/lbs).

READ, THEN KEEP THESE INSTRUCTIONS FOR FUTURE REFERENCE

WARNINGS AND IMPORTANT SAFETY PRECAUTIONS

⚠ WARNING INSTALLERS, POOL OPERATORS AND POOL OWNERS MUST READ THESE WARNINGS AND ALL INSTRUCTIONS BEFORE USING THIS PRODUCT!

⚠ DANGER SERIOUS BODILY INJURY OR DEATH CAN RESULT IF THIS PRODUCT IS NOT INSTALLED AND USED CORRECTLY.

⚠ DANGER THIS COVER MUST ONLY BE INSTALLED AND USED WITH THE SUPPLIED PENTAIR WATER POOL AND SPA® FRAME OR WITH AN EXISTING PENTAIR POOL PRODUCTS® OR AMERICAN PRODUCTS® FRAME THAT IS IN GOOD CONDITION AND HAS INTACT BRASS INSERTS. THIS COVER IS INCOMPATIBLE WITH ANY OTHER FRAME. IF THE POOL OR SPA HAS AN EXISTING FRAME (OTHER THAN ONE IN GOOD CONDITION WITH INTACT BRASS INSERTS MANUFACTURED BY PENTAIR POOL PRODUCTS OR AMERICAN PRODUCTS), THE EXISTING FRAME MUST FIRST BE REMOVED AND THE NEW SUPPLIED FRAME INSTALLED. DO NOT INSTALL THIS COVER ON ANY OTHER STYLE OF FRAME OR ANOTHER MANUFACTURER'S FRAME. FAILURE TO FOLLOW THIS WARNING MAY RESULT IN A SUCTION ENTRAPMENT HAZARD AND CAN CAUSE LIMB AND BODY ENTRAPMENT OR EVISCERATION.

⚠ WARNING FOR USE WITH MULTIPLE SUBMERGED SUCTION OUTLETS OR A SINGLE SUBMERGED SUCTION OUTLET. IF ONLY A SINGLE SUCTION OUTLET OR MAIN DRAIN EXISTS, A SAFETY VACUUM RELEASE SYSTEM (SVRS) SUCH AS THE PENTAIR WATER POOL AND SPA INTELLIFLO® VS+ SVRS PUMP, A GRAVITY DRAINAGE SYSTEM, AN AUTOMATIC SHUT-OFF SYSTEM OR A SUCTION-LIMITING VENT SYSTEM MUST BE USED.

⚠ WARNING IMPROPER INSTALLATION OR USE OF THIS PRODUCT MAY PRESENT A RISK OF HAIR OR BODY ENTRAPMENT AND DROWNING. INSTALL THIS EQUIPMENT IN ACCORDANCE WITH THE INSTRUCTIONS PROVIDED. USE ONLY WITH THE COMPONENTS AND MOUNTING HARDWARE PROVIDED. FAILURE TO FOLLOW THESE INSTRUCTIONS AND/OR USE WITH COMPONENTS NOT PROVIDED BY PENTAIR POOL PRODUCTS® AND INTENDED TO BE USED WITH THIS PRODUCT MAY RESULT IN IMPROPER POSITIONING OR FUNCTIONING OF DRAIN COVER AND MAY CAUSE SEVERE PERSONAL INJURY OR DEATH.

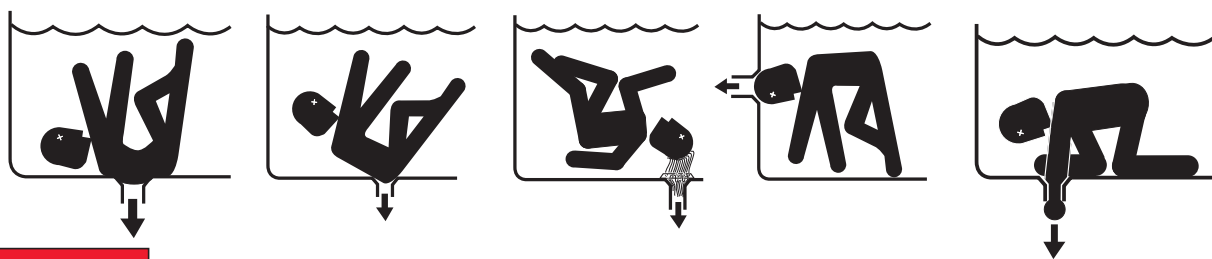

⚠ DANGER SUCTION ENTRAPMENT HAZARD

Pool and spa pumps produce high levels of suction, which can pose extreme danger if a person comes in close proximity to an open pool or spa drain or if a drain cover is loose, cracked, broken or missing.

Pool and spa pumps move large volumes of water, which can pose extreme danger if a person's hair comes in close proximity to a drain that is not the proper size for the pump or pumps.

Suction entrapment dangers include:

Hair Entanglement – When the hair tangles or knots in the drain cover, trapping the swimmer underwater. This hazard is present when the flow rating of the cover is too small for the pump or pumps.

Limb Entrapment – When a limb is sucked or inserted into an opening resulting in a mechanical bind or swelling. This hazard is present when a drain cover is missing, broken, loose, cracked or not properly secured.

Body Entrapment – When a portion of the body is held against the drain cover trapping the swimmer underwater. This hazard is present when the drain cover is missing, broken or the cover flow rating is not high enough for the pump or pumps.

WARNINGS AND IMPORTANT SAFETY PRECAUTIONS

Evisceration/Disembowelment – When a person sits on an open pool (particularly a child wading pool) or spa outlet and suction is applied directly to the intestines, causing severe intestinal damage. This hazard is present when the drain cover is missing, loose, cracked, or not properly secured.

Mechanical Entrapment – When jewelry, swimsuit, hair decorations, finger, toe or knuckle is caught in an opening of an outlet or drain cover. This hazard is present when the drain cover is missing, broken, loose, cracked, or not properly secured.

⚠ WARNING Use these fittings only with a pumping system rated for the corresponding flow or less for 2 inch plumbing (see sump diagram on page 5). **FAILURE TO DO SO CAN RESULT IN HAIR OR BODY ENTRAPMENT WHICH CAN CAUSE SEVERE PERSONAL INJURY OR DEATH.** If in doubt about the rating of your system, consult a qualified pool or spa professional.

IMPORTANT NOTICE

Regularly inspect all drain covers for cracks, damage and advanced weathering. If a drain cover becomes loose, cracked, damaged, broken or is missing, close the pool or spa immediately, post a notice and keep the pool or spa closed until an appropriate ANSI/APSP-16 2011 certified drain cover is properly installed. Drain covers deteriorate over time due to exposure to sunlight and pool chemicals. This drain cover must be replaced within seven (7) years from installation (or earlier if the cover becomes damaged in any way).

⚠ WARNING An ANSI/APSP-16 2011 approved anti-entrapment drain cover must be used for each drain. Pools and spas should utilize two drains per pump. If a drain cover becomes loose, broken or is missing, close the pool or spa immediately and shut off the pump until an approved anti-entrapment drain cover is properly installed with the supplied stainless steel screws. Only the supplied 316 stainless-steel screws should be used with the drain cover. Substitute screws such as masonry screws, sheet rock screws or other types of screws should never be used. Screws put into the frame anywhere except in the original screw holes will not hold and will allow the drain cover to come off the main drain, causing an entrapment hazard, including possible limb and body entrapment or evisceration/disembowelment. If the screw holes of the frame are stripped or the brass inserts are missing, loose, or damaged, replace the frame. **DO NOT DRILL NEW SCREW HOLES IN THE FRAME AS THIS WILL DAMAGE AND WEAKEN THE FRAME.**



IMPORTANT NOTICE

Attention Installer: This manual contains important information about the installation, operation and safe use of this product. This information should be given to the owner and/or operator of this equipment. Please refer to www.pentair.com for all warnings and instructions related to the StarGuard® 8-inch Round Main Drain.

⚠ WARNING Before installing this product, read and follow all warning notices and instructions which are included. Failure to follow safety warnings and instructions can result in severe injury, death, or property damage. Call (800) 831-7133 for additional free copies of these instructions. It is absolutely critical that the suction plumbing be installed in accordance with the latest national and local codes for swimming pools.

⚠ DANGER A pool/spa pump produces high levels of suction, which can pose extreme danger if a person comes in close proximity to an open pool or spa drain or a loose or broken drain cover or grate.

Hydrostatic relief valve

For installations utilizing a hydrostatic relief valve, using a collector tube will maintain a clear path to the hydrostatic valve. At least one hydrostatic relief valve in a set of suction outlets will allow hydrostatic uplift pressure caused by ground water to be relieved into the pool or spa.

WARNINGS AND IMPORTANT SAFETY PRECAUTIONS

Entrapment Avoidance Notice:

The covers used on suction outlets should be approved and listed as conforming to the currently published edition of **ANSI/APSP-16 2011** Standard. These covers should be inspected regularly and replaced if cracked, broken or older than the design lifetime indicated on them by the manufacturer. The maximum possible flow rate of the pump should be less than or equal to the maximum approved flow rate indicated on the suction outlet cover by the manufacturer. **THE USE OF UNAPPROVED COVERS OR ALLOWING USE OF THE POOL OR SPA WHEN COVERS ARE MISSING, CRACKED OR BROKEN CAN RESULT IN BODY OR LIMB ENTRAPMENT, HAIR ENTANGLEMENT, EVISCERATION AND DEATH.**

⚠ WARNING Pumps improperly sized or installed or used in applications other than for which the pump was intended can result in severe personal injury or death. These risks may include but not be limited to electric shock, fire, flooding, suction entrapment or severe injury or property damage caused by a structural failure of the pump or other system component.

⚠ WARNING The use of alcohol, drugs, or medication can greatly increase the risk of fatal hyperthermia in hot tubs and spas.

⚠ WARNING To reduce the risk of injury, do not permit children to use this product unless they are closely supervised at all times.

⚠ WARNING When setting up pool water turnovers or flow rates the operator must consider local codes governing turnover as well as disinfectant feed ratios.

⚠ WARNING DO NOT increase pump size; this will increase the flow rate through the system and exceed the maximum flow rate stated on the drain cover.

WARNINGS AND IMPORTANT SAFETY PRECAUTIONS

⚠ WARNING Most states and local codes regulate the construction, installation, and operation of public pools and spas, and the construction of residential pools and spas. It is important to comply with these codes, many of which directly regulate the installation and use of this product. Consult the local building and health codes for more information.

- Dual suction fittings shall not be located on seating areas or on the back rests for such seating areas.
- If the pool or spa has only a single suction outlet or main drain, a Safety Vacuum Release System (SVRS) such as the Pentair Water Pool and Spa IntelliFlo® VS+SVRS pump, a gravity drainage system, an automatic shut-off system or a suction-limiting vent system **MUST** be used.
- In the event one suction outlet is completely blocked, the remaining suction outlets serving the system shall have a flow rating capable of the full flow of the pump(s) for the specific system.
- An approved anti-entrapment suction outlet cover must be used for each drain.
- Never exceed the maximum flow rate stated on the drain cover.
- Before each use of the facility the suction fitting, including fasteners, should be inspected for damage or tampering.
- Close the pool or spa if any suction outlet component is loose, cracked, broken, missing or not securely attached. Replace loose, cracked, damaged, broken or missing drain covers.
- In addition to two or more suction outlets per pump (Figure 2) installed in accordance with the latest APSP standards and CPSC guidelines, follow all applicable national, state and local codes.
- The suction outlet to a swimming pool pump pulls a high vacuum. If pump is used with only one suction pipe, anyone blocking pump suction with hair or body will be trapped and held against the suction fitting. Disembowelment or drowning can result.
- To prevent entrapment, install at least two suction outlet (main drains) fittings per pump in pool. Separate these outlets by either of the following procedures.
 - A. Locate the outlets at least three (3) feet apart.
 - B. Locate the outlets in two (2) different planes (Figure 1), (for example, one on the bottom and one on a vertical side wall, or on two separate vertical side walls). Use multiple suction sources to reduce risk of entrapment. Failure to maintain fittings and covers can lead to severe injury or death. Use of fittings when covers are broken, loose or missing can lead to severe injury or death. If using 1½ in. plumbing. Consult your local building dept. for codes or ordinances that may apply.
- Remove the pressure test plugs and/or plugs used in winterization of the pool/spa from the suction outlets.

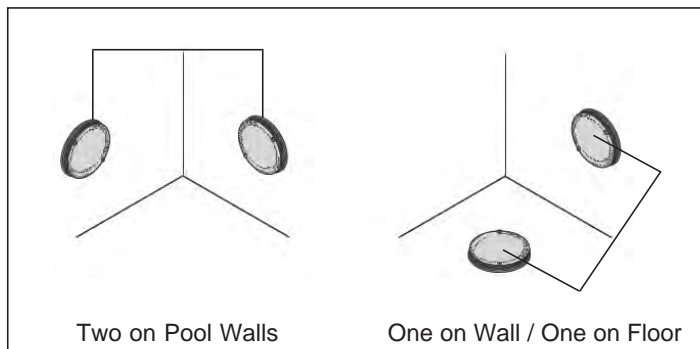

Figure 1: Alternate Location for Suction Outlets

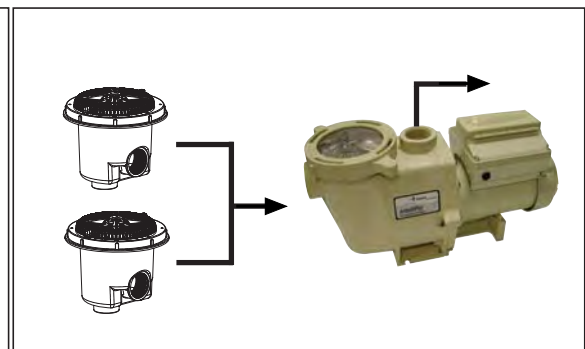

Figure 2: Two Suction Outlets per Pump

If you have any questions about installation or maintenance of this drain cover, please contact your pool professional. Never attempt to alter or repair the cover or frame on your own.

VIRGINIA GRAEME BAKER POOL AND SPA SAFETY ACT

The Virginia Graeme Baker Pool and Spa Safety Act raises certain new requirements on owners and operators of swimming pools and spas.

Pools or spas constructed on or after December 19, 2008, shall utilize:

- (A) A multiple main drain system without isolation capability with suction outlet covers that meet ANSI/APSP-16 Suction Fittings for Use in Swimming Pools, Wading Pools, Spas, and Hot Tubs and either:
 - (i) A safety vacuum release system (SVRS) meeting ASME/ANSI A112.19.17 Manufactured Safety Vacuum Release Systems (SVRS) for Residential and Commercial Swimming Pool, Spa, Hot Tub, and Wading Pool Suction Systems and/or ASTM F2387 Standard Specification for Manufactured Safety Vacuum Release Systems (SVRS) for Swimming Pools, Spas and Hot Tubs or
 - (ii) A properly designed and tested suction-limiting vent system or
 - (iii) An automatic pump shut-off system.

Pools and spas constructed prior to December 19, 2008, with a single submerged suction outlet shall use a suction outlet cover that meets ANSI/APSP-16 and either:

- (A) A safety vacuum release system (SVRS) meeting ASME/ANSI A112.19.17 and/or ASTM F2387, or
- (B) A properly designed and tested suction-limiting vent system, or
- (C) An automatic pump shut-off system, or
- (D) Disabled submerged outlets, or
- (E) Suction outlets shall be reconfigured into return inlets.

For more information about the Virginia Graeme Baker Pool and Spa Safety Act, contact the Consumer Product Safety Commission at (301) 504-7908 or visit www.cpsc.gov.

NOTE: Always turn off all power to the pool pump before installing the cover or working on any suction outlet.

ACTS CODES AND STANDARDS

Important Acts Codes and Standards Information

StarGuard® and all suction outlet fittings (drain covers) are federally regulated by the U.S. Consumer Product Safety Commission (CPSC). This authority was given to the CPSC in 2007 as part of the Virginia Graeme Baker Pool and Spa Safety Act. Visit www.cpsc.org for more information.

ANSI/APSP-16 2011 Certification

These suction fittings, for use in swimming pools, wading pools, spas and hot tubs, were tested and certified to the aforementioned safety regulations, by IAPMO Research and Testing, 5001 E. Philadelphia St. Ontario, CA 91761 – USA 877-4UPCMARK (toll free). Product certification commenced April 2009, test results can be obtained from: www.pentairwater.com and/or <http://pld.iapmo.org/>

NSF/ANSI-50

StarGuard® is certified to comply with NSF/ANSI 50 Circulation system components and related materials for swimming pools, spas/hot tubs. To download a current copy of the IAPMO certification, go to <http://www.iapmort.org>.

Virginia Graeme Baker Pool and Spa Safety Act

StarGuard® is certified to comply with the Virginia Graeme Baker Pool and Spa Safety Act, Section 1404(b). This section requires all suction outlet fittings (drain covers) to conform to ANSI/APSP-16 2011.

International Code Council

StarGuard® is an approved component as required by the International Code Council (ICC) building codes, which include the International Residential Code (IRC), and the International Building Code (IBC), collectively known as the iCodes. The ICC updates the iCodes every three years. For more information, visit www.iccsafe.org.

International Residential Code (IRC)

Many states and local jurisdictions have adopted the IRC, including Appendix G. Section AG106 addresses Suction Entrapment Avoidance requirements that regulate residential swimming pools and spas. It is important to know if these codes are in effect where the residential pool or spa is being built and which version is being required. Effective in the 2009 version of the IRC is the requirement to build in accordance with ANSI/APSP 7 - 2006 American National Standard for Suction Entrapment Avoidance in Swimming Pools, Wading Pools, Spas, Hot Tubs, and Catch Basins. 2003 and 2006 versions do not include a reference to the ANSI/APSP 7 standard, instead they included the requirement that all pools and spas be equipped with dual-drains and a vacuum relief system that can be either an Approved Gravity Drainage System, or a Safety Vacuum Release System (SVRS) such as the IntelliFlo® VS+ SVRS pump. Visit www.iccsafe.org for more information.

International Building Code (IBC)

Many states and local jurisdictions have adopted the International Building Code which regulates commercial building projects, including public swimming pools and spas. Section 3109.5 addresses Suction Entrapment Avoidance requirements that regulate public swimming pools and spas. It is important to know if these codes are in effect where the public pool or spa is being built and which version is being required. Effective in the 2009 version of the IBC is the requirement to build in accordance with ANSI/APSP 7 - 2006 American National Standard for Suction Entrapment Avoidance in Swimming Pools, Wading Pools, Spas, Hot Tubs, and Catch Basins. 2003 and 2006 versions do not include a reference to the ANSI/APSP 7 standard, instead they included the requirement that all pools and spas be equipped with dual-drains and a vacuum relief system that can be either an Approved Gravity Drainage System, or a Safety Vacuum Release System (SVRS) such as the IntelliFlo® VS+ SVRS pump. Visit www.iccsafe.org for more information.

ANSI/APSP-7 Suction Entrapment Avoidance Standard

The Association of Pool and Spa Professionals publishes many swimming pool and spa related standards, including ANSI/APSP 7 - 2006 American National Standard for Suction Entrapment Avoidance in Swimming Pools, Wading Pools, Spas, Hot Tubs, and Catch Basins. ANSI/APSP 7 is referenced by the iCodes, and is required by some states and local jurisdictions. It requires all suction outlet fittings (drain covers) to be tested and Listed by a nationally recognized testing laboratory as conforming to most recent version of ANSI/APSP-16 2011. Visit www.apsp.org for more information.

Hydraulic System Specifications

POOL PUMP SUCTION REQUIREMENTS

Pump suction is hazardous and can trap and drown or disembowel bathers. Do not use or allow anyone else to use a pool, spa, or hot tub unless it has at least two (2) suction outlets to each pump suction line (see Figure 1, Outlets Per Pump, below). Do not use or operate swimming pools, spas, or hot tubs if a suction outlet cover is missing, broken, or loose. Follow the guidelines below for a pump installation which minimizes risk to users of pools, spas, and hot tubs.

Entrapment Protection

The pump suction system must provide protection against the hazard of suction entrapment or hair entrapment/entanglement.

Suction Outlet Covers

All suction outlet covers must be maintained. They must be replaced if cracked, broken, or missing. See Page vii for outlet cover certification requirements. All suction outlets must have correctly installed, screw-fastened covers in place.

Outlets Per Pump

Provide at least two (2) hydraulically balanced main drains, with covers (see Figure 1), for each swimming pool pump suction line. The centers of the main drains (suction fittings) must be at least three (3) feet apart.

The system must be built so that it cannot operate with the pump drawing water from only one (1) main drain (that is, there must be at least two (2) main drains connected to the pump whenever it is running, see Figure 1). However, if two (2) main drains run into a single suction line, the single suction line may be equipped with a valve which will shut off both main drains from the pump (see Figure 1).

For existing single drain pools and spas, or multiple main drains located less than three feet apart, a backup system must be installed, such as the IntelliFlo® VS +SVRS Pump. Other backup systems include, approved gravity draining systems, or suction-limiting vent.

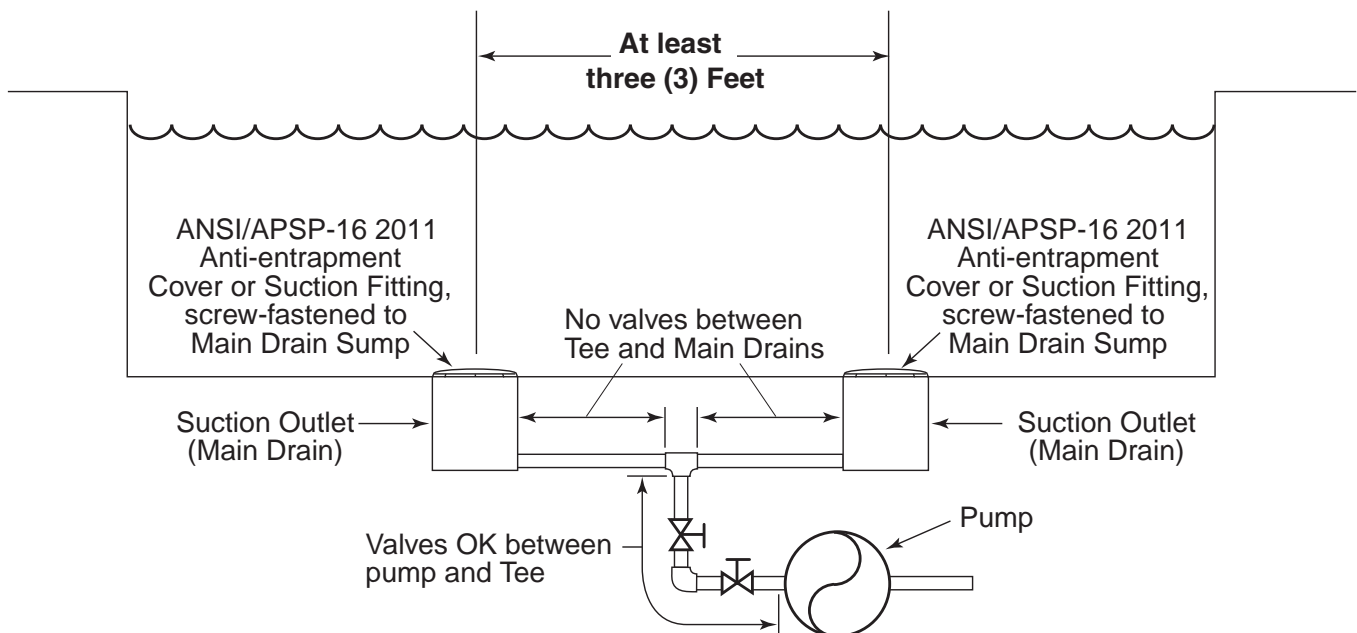

Figure 1: Outlets Per Pump

Water Velocity and Flow Rates

The maximum water velocity through drain covers is limited by some local regulations, for example some state health departments limit the velocity through public pool drain covers to 1-1/2 feet per second. This velocity limit is lower than the flow rating provided by the ANSI/APSP-16 2011 certification, therefore local limit applies and must be followed. Never exceed the flow rating listed on the cover even if local code does not provide a velocity limit, see Chart 2 on page 2.

Piping – General

For new installations, the piping between drains must be sized to limit the velocity to six (6) feet per second. This limit applies to the branch piping and all fittings between multiple outlets and the tee leading back to the pump. If code requires a lower water velocity, comply with the code. See the table below for information on pipe size flow ratings at six (6) feet per second.

Acceptable Pipe Size for Maximum Recommended System Flow Rate Per APSP-7 (6 ft./sec. in the Branch Line)

CHART 1	
Pipe Size Inch (mm)	Flow Rate GPM (L/Min.)
1-1/2" (50)	37 (140)
2" (63)	62 (233)
2-1/2" (75)	88 (332)
3" (90)	136 (514)

Flow Rate Based on Open Area and Velocity (Q=AV)

CHART 2					
cm ²	cm/m	1pm	Open Area (A) in ²	Velocity ft/sec. (V)	Flow GPM (Q)
99.0	46	271	15.3516	1.5	71.7
99.0	61	361	15.3516	2.0	95.6
99.0	76	453	15.3516	2.5	119.6
99.0	91	543	15.3516	3.0	143.5
99.0	107	634	15.3516	3.5	167.4
99.0	122	724	15.3516	4.0	191.3
99.0	137	814	15.3516	4.5	215.2
99.0	152	905	15.3516	5.0	239.1
99.0	168	996	15.3516	5.5	263.0
99.0	183	1086	15.3516	6.0	286.9

StarGuard® Main Drain Gallons Per Minute (GPM) Ratings

CHART 3			
Part No.	Open Area	Flow Rating Floor	Flow Rating Wall
50010X	15.35 in ²	144 GPM	112 GPM
50011X	15.35 in ²	144 GPM	112 GPM
50012X	15.35 in ²	144 GPM	112 GPM
50013X	15.35 in ²	144 GPM	112 GPM

StarGuard Cover Pressure Drop Curve (Head Loss)

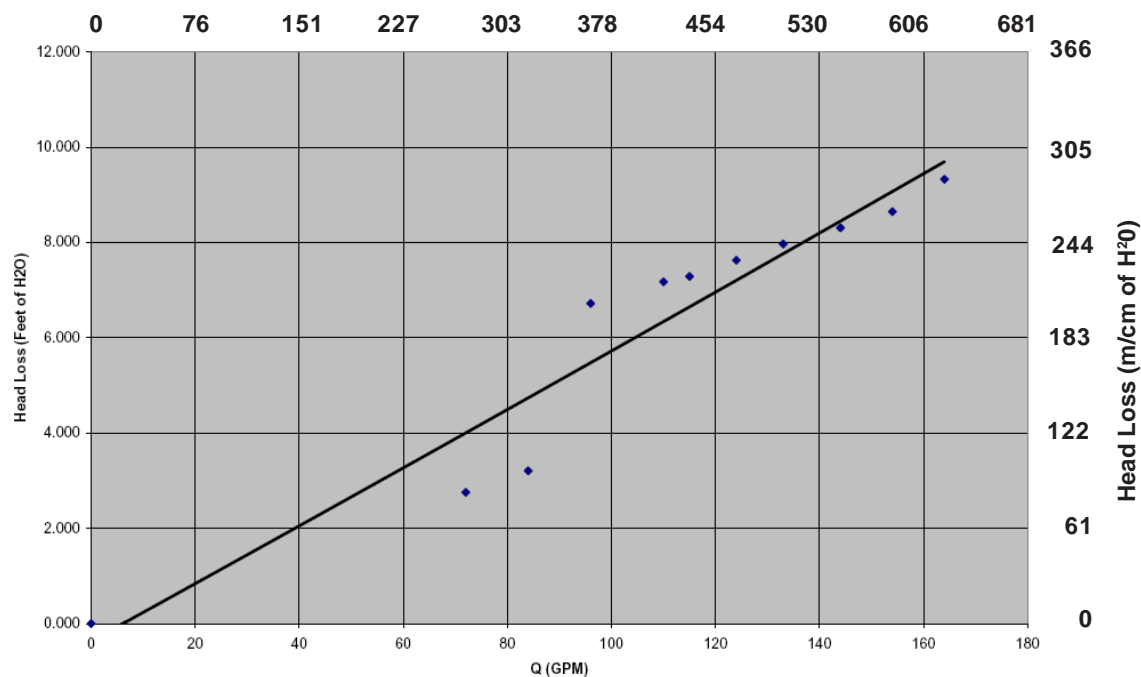

Section 1

Field Fabricated Sump Installation

The following describes the installation requirements and procedure for a new field fabricated sump. For the StarGuard® 8 inch round main drain cover (with long or short face ring) installation, see page 4.

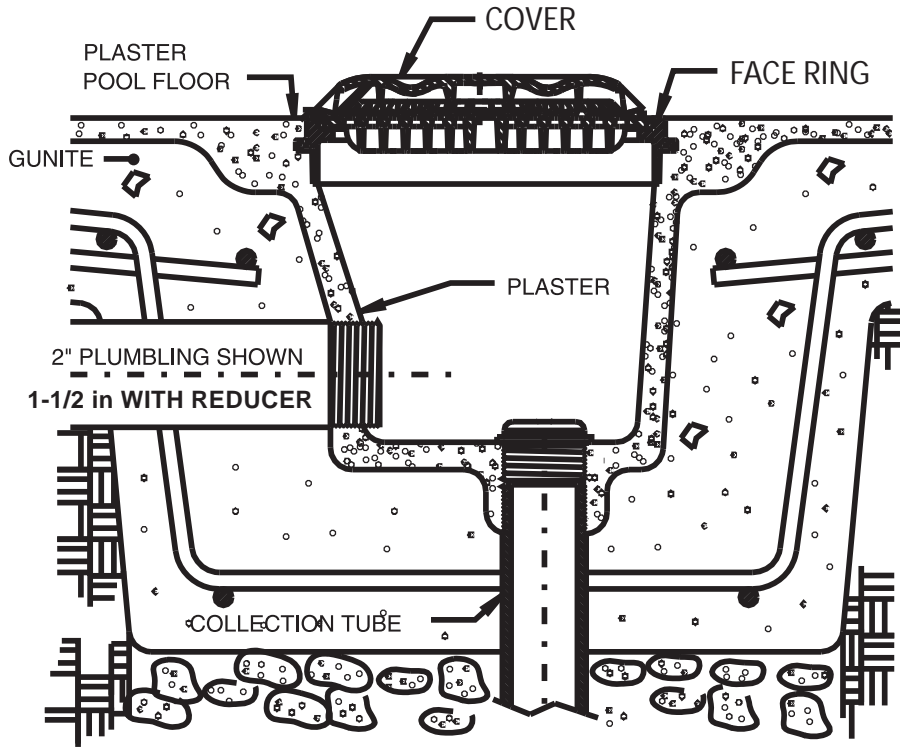

Field Fabricated Sump Installation Diagram

Field Fabricated Sump Specifications for Dual Submerged Suction Outlet

Field fabricated sumps must be built in accordance with the specifications shown in diagrams below.

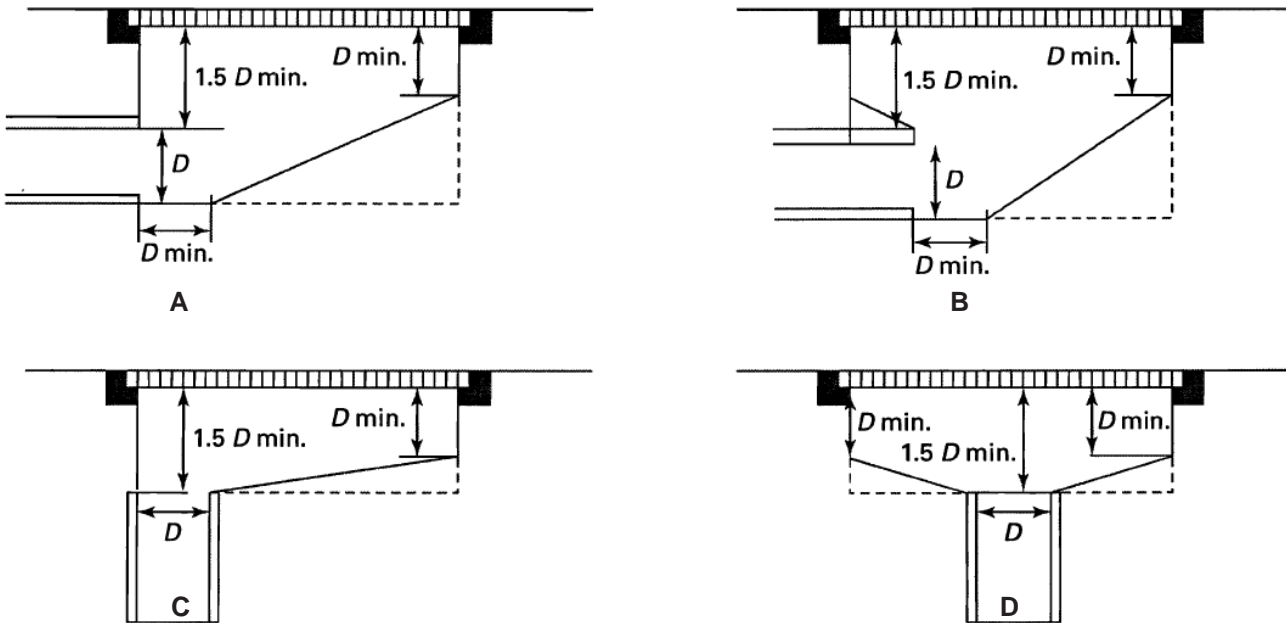

Note: A) D = inside pipe diameter. B) All dimensions shown are minimum measurements. C) A broken line (-----) indicates suggested sump configuration.

Section 2

StarGuard® 8-inch Round Main Drain Cover (with Long or Short Face Ring) Installation

The following describes how to install an 8 inch round main drain cover (with long face ring) or a replacement main drain cover (with short face ring) for a field fabricated sump.

Model	Description	Model	Description
500121	8" MAIN DRAIN, COVER/LONG RING BLK	500140	8" MAIN DRAIN, COVER/LONG RING WHT 2PK
500101	8" MAIN DRAIN, COVER/LONG RING DG	500141	8" MAIN DRAIN, COVER/LONG RING BLK 2PK
500102	8" MAIN DRAIN, COVER/LONG RING GRY	500142	8" MAIN DRAIN, COVER/LONG RING DG 2PK
500103	8" MAIN DRAIN, COVER/SHORT RING WHT	500143	8" MAIN DRAIN, COVER/LONG RING GRY 2PK
500112	8" MAIN DRAIN, COVER/SHORT RING BLK	500144	8" MAIN DRAIN, COVER/SHORT RING WHT 2PK
500105	8" MAIN DRAIN, COVER/SHORT RING DG	500145	8" MAIN DRAIN, COVER/SHORT RING BLK 2PK
500106	8" MAIN DRAIN, COVER/SHORT RING GRY	500146	8" MAIN DRAIN, COVER/SHORT RING DG 2PK
500108	8" MAIN DRAIN, COVER/LONG RING WHT	500147	8" MAIN DRAIN, COVER/SHORT RING GRY 2PK

New Drain Cover and Long Face Ring Installation

- ⚠ WARNING** BEFORE INSTALLING THIS PRODUCT, INSTALLERS, POOL OPERATORS AND POOL OWNERS MUST READ AND UNDERSTAND ALL WARNINGS AND SAFETY PRECAUTIONS SET FORTH ON PAGES ii-vii AND PAGES 1-2 OF THIS INSTALLATION GUIDE.

⚠ WARNING ONLY USE THE 316 STAINLESS STEEL 8-32 MACHINE SCREWS PROVIDED. SUBSTITUTE SCREWS SUCH AS MASONRY SCREWS, SHEET ROCK SCREWS OR OTHER TYPES OF SCREWS SHOULD NEVER BE USED, WILL CAUSE THE COVER TO COME LOOSE AND COULD RESULT IN LIMB OR BODY ENTRAPMENT, HAIR ENTANGLEMENT OR EVisCERATION/DISEMBOWELMENT.

⚠ WARNING IF THE FACE RING, SUMP, SCREW OR SCREW HOLES ARE DAMAGED IN ANY WAY THAT PREVENTS COMPLETE INSERTION OF THE SPECIFIED SCREW, THE FACE RING, SUMP OR DAMAGED SCREW MUST BE REPLACED. DO NOT ATTEMPT TO MODIFY OR ALTER ANY COMPONENT IN ANY WAY.
- Install the face ring onto the suction outlet in accordance with: **Section 1, Field Fabricated Sump Installation diagram, page 3.**
- Mount the drain cover on top of the face ring/suction outlet (see Figure 1).
- Rotate the cover to align the screw holes. The cover notch and face ring tab will seat the cover in place.
- Install the two (2) 316 stainless steel 8-32 machine screws (provided) into the holes in the top of the cover. Using a No. 2 Philips head screwdriver, tighten each retaining screw to a **torque value of 10.00 (minimum) to 15.0 (maximum) in/lbs** to secure the cover. DO NOT OVER TIGHTEN THE SCREWS. DO NOT ASSEMBLE WITH POWER TOOLS.

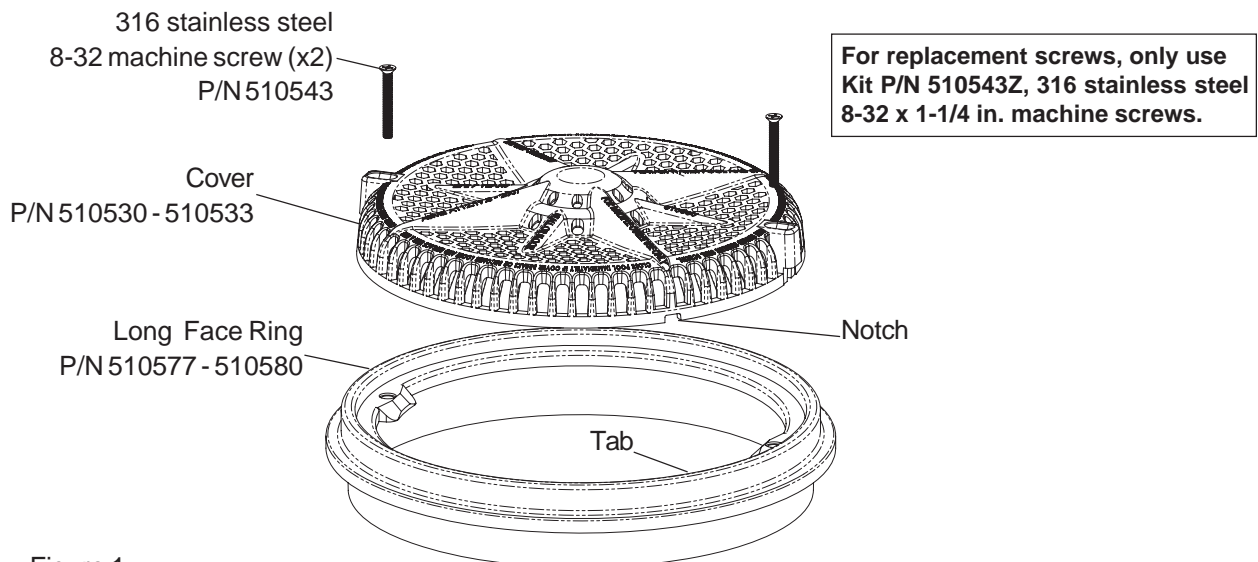

Figure 1

Replacement Cover and Short Face Ring Installation

⚠ WARNING IF THE EXISTING MAIN DRAIN COVER HAS A FACE RING WITHOUT THREADED INSERTS, YOU MUST REPLACE THE EXISTING FACE RING WITH A NEW FACE RING.

To replace the cover and short face ring:

1. **⚠ WARNING** BEFORE INSTALLING THIS PRODUCT, INSTALLERS, POOL OPERATORS AND POOL OWNERS MUST READ AND UNDERSTAND ALL WARNINGS AND SAFETY PRECAUTIONS SET FORTH ON PAGES ii-vii AND PAGES 1-2 OF THIS INSTALLATION GUIDE.

⚠ WARNING ONLY USE THE 316 STAINLESS STEEL 8-32 MACHINE SCREWS PROVIDED. SUBSTITUTE SCREWS SUCH AS MASONRY SCREWS, SHEET ROCK SCREWS OR OTHER TYPES OF SCREWS SHOULD NEVER BE USED, WILL CAUSE THE COVER TO COME LOOSE AND COULD RESULT IN LIMB OR BODY ENTRAPMENT, HAIR ENTANGLEMENT OR EVISCEATION/DISEMBOWELMENT.

⚠ WARNING IF THE FACE RING, SUMP, SCREW OR SCREW HOLES ARE DAMAGED IN ANY WAY THAT PREVENTS COMPLETE INSERTION OF THE SPECIFIED SCREW, THE FACE RING, SUMP OR DAMAGED SCREW MUST BE REPLACED. DO NOT ATTEMPT TO MODIFY OR ALTER ANY COMPONENT IN ANY WAY.

2. Remove the existing cover from the face ring and discard.
3. Remove the existing face ring (**without threaded inserts**) from the pool and discard.
NOTE: If the face ring has threaded inserts, skip steps 3 and 4, and proceed to Step 5.
4. Install the face ring onto the suction outlet.
5. Mount the drain cover on top of the face ring/suction outlet (see Figure 2).
6. Rotate the cover to align the screw holes. The cover notch and face ring tab will seat the cover in place.
7. Install the two (2) 316 stainless steel 8-32 machine screws (provided) into the holes in the top of the cover. Using a No. 2 Philips head screwdriver, tighten each retaining screw to a **torque value of 10.00 (minimum) to 15.0 (maximum) in/lbs** to secure the cover. DO NOT OVER TIGHTEN THE SCREWS. DO NOT ASSEMBLE WITH POWER TOOLS.

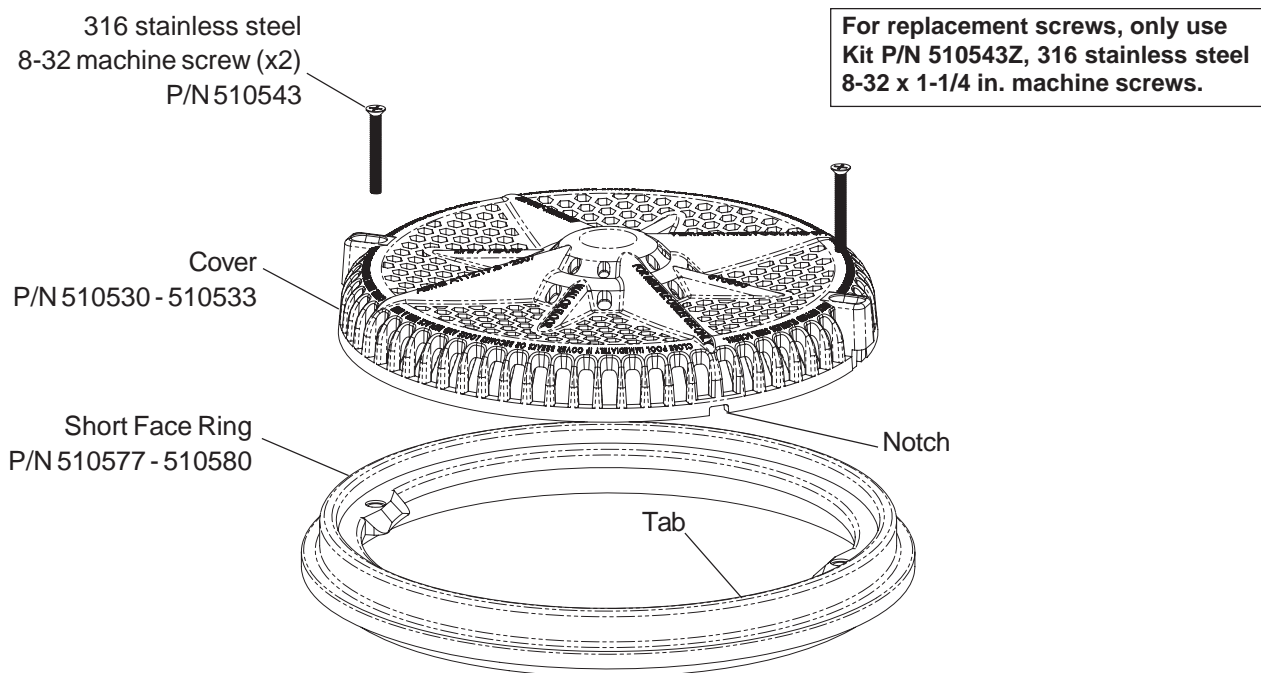
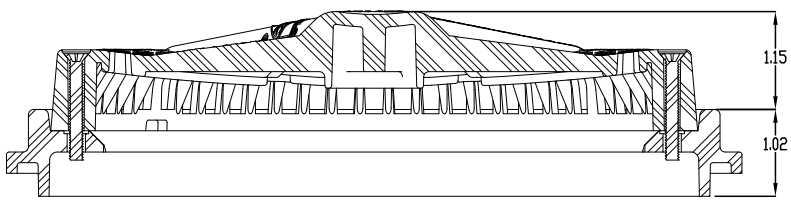
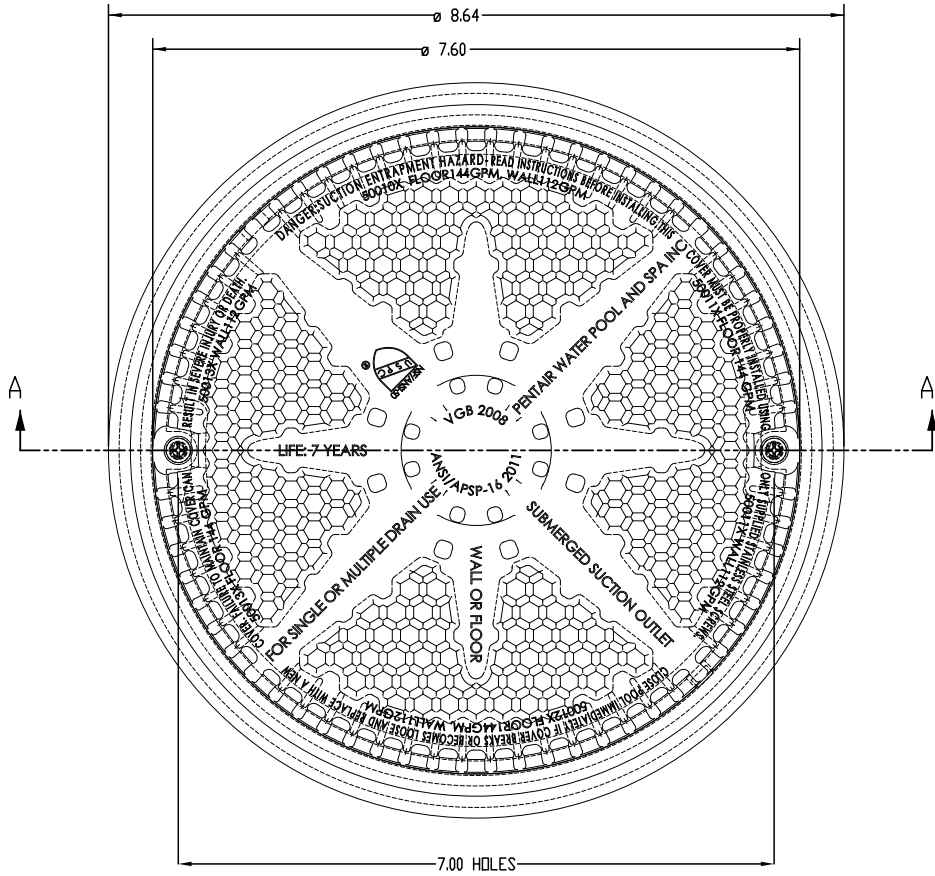
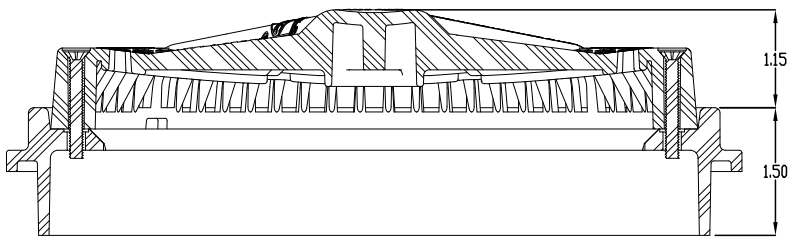

Figure 2

Dimensions - StarGuard® 8-inch Drain with Face Ring



Model 50010X (short face ring)



Model 50010X (long face ring)

Section 3

StarGuard® 8-inch Round Drain Two Port (2" NPSM Side x 1-1/2" NPSM Bottom) Installation (Model 500110 - 500114)

The following describes the installation requirements and procedure for a StarGuard 8 inch Round Drain (Two Port).

Model	Description
500110	8" MAIN DRAIN, 2" SIDE X 1-1/2" BOT PORTS ABS SUMP w/ RING AND COVER WHT 2PK
500111	8" MAIN DRAIN, 2" SIDE X 1-1/2" BOT PORTS ABS SUMP w/ RING AND COVER BLK 2PK
500113	8" MAIN DRAIN, 2" SIDE X 1-1/2" BOT PORTS ABS SUMP w/ RING AND COVER DG 2PK
500114	8" MAIN DRAIN, 2" SIDE X 1-1/2" BOT PORTS ABS SUMP w/ RING AND COVER GRY 2PK

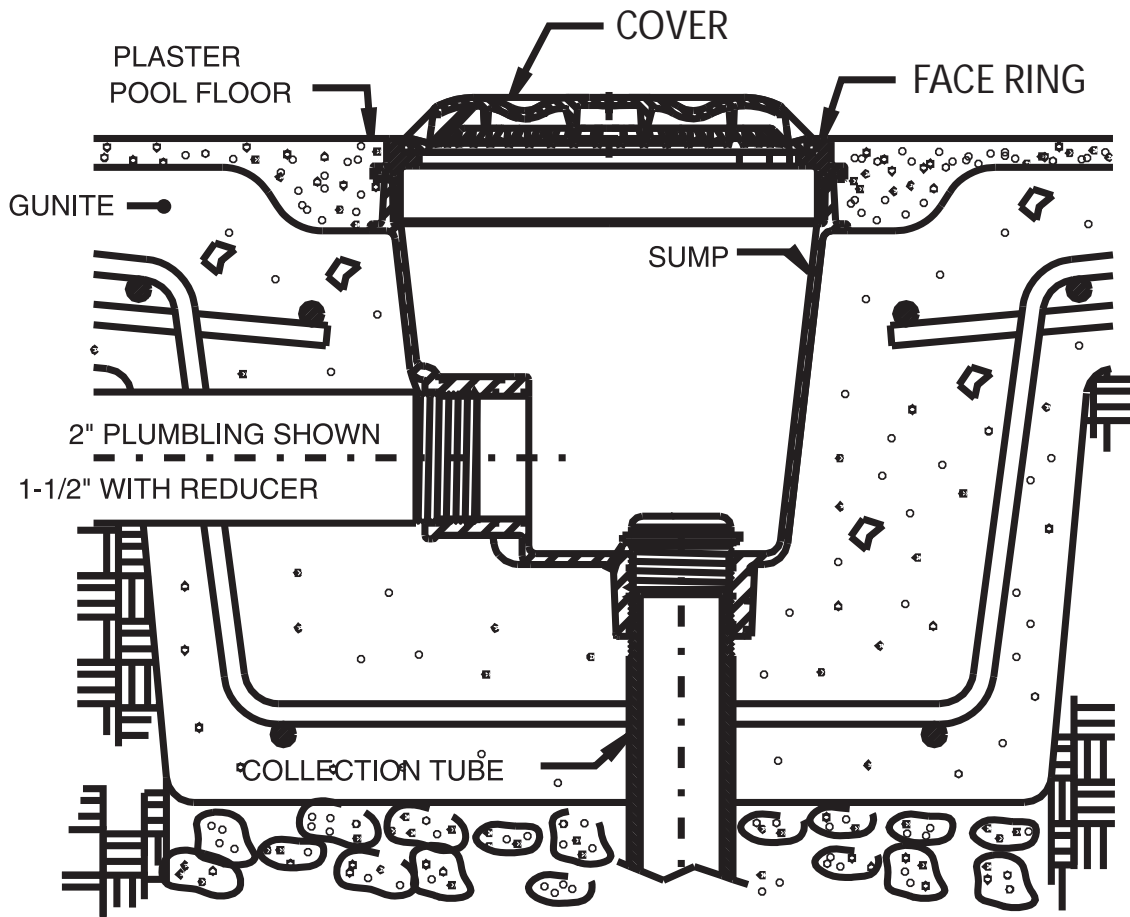

Sump Installation Diagram

Two Port Main Drain Installation

- ⚠ WARNING** BEFORE INSTALLING THIS PRODUCT, INSTALLERS, POOL OPERATORS AND POOL OWNERS MUST READ AND UNDERSTAND ALL WARNINGS AND SAFETY PRECAUTIONS SET FORTH ON PAGES ii-vii AND PAGES 1-2 OF THIS INSTALLATION GUIDE.

⚠ WARNING ONLY USE THE 316 STAINLESS STEEL 8-32 MACHINE SCREWS PROVIDED. SUBSTITUTE SCREWS SUCH AS MASONRY SCREWS, SHEET ROCK SCREWS OR OTHER TYPES OF SCREWS SHOULD NEVER BE USED, WILL CAUSE THE COVER TO COME LOOSE AND COULD RESULT IN LIMB OR BODY ENTRAPMENT, HAIR ENTANGLEMENT OR EVISCEATION/DISEMBOWELMENT.

⚠ WARNING IF THE FACE RING, SUMP, SCREW OR SCREW HOLES ARE DAMAGED IN ANY WAY THAT PREVENTS COMPLETE INSERTION OF THE SPECIFIED SCREW, THE FACE RING, SUMP OR DAMAGED SCREW MUST BE REPLACED. DO NOT ATTEMPT TO MODIFY OR ALTER ANY COMPONENT IN ANY WAY.
- Install the sump and face ring onto the suction outlet in accordance with: **Section 3, Sump Installation Diagram, page 7.**
- Mount the drain cover on top of the face ring/suction outlet (see Figure 1).
- Rotate the cover to align the screw holes. The cover notch and face ring tab will seat the cover in place.
- Install the two (2) 316 stainless steel 8-32 machine screws (provided) into the holes in the top of the cover. Using a No. 2 Philips head screwdriver, tighten each retaining screw to a **torque value of 10.00 (minimum) to 15.0 (maximum) in/lbs** to secure the cover. DO NOT OVER TIGHTEN THE SCREWS. DO NOT ASSEMBLE WITH POWER TOOLS.

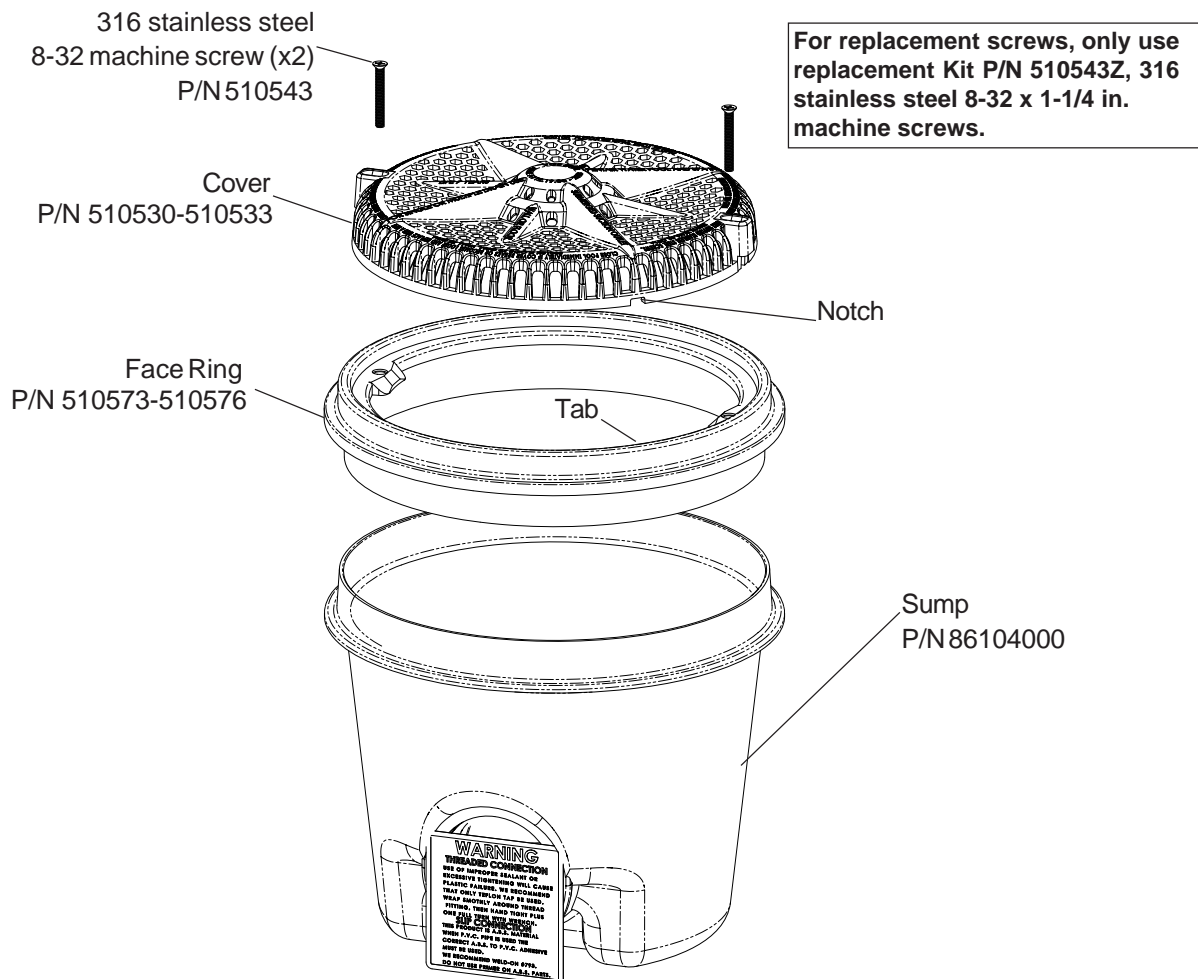

Figure 1

Section 4

StarGuard® 8-inch Round Main Drain Single Port (2" NPSM side) Installation

Model 500115 - 500119

The following describes the installation requirements and procedure for a StarGuard 8 inch round main drain (Single Port). For the StarGuard 8 inch round cover and face ring installation, see page 11.

Model Description

500115 8" MAIN DRAIN, 2" SIDE PORT ABS SUMP WITH RING AND COVER WHT 2PK

500116 8" MAIN DRAIN, 2" SIDE PORT ABS SUMP WITH RING AND COVER BLK 2PK

500117 8" MAIN DRAIN, 2" SIDE PORT ABS SUMP WITH RING AND COVER DG 2PK

500118 8" MAIN DRAIN, 2" SIDE PORT ABS SUMP WITH RING AND COVER GRY 2PK

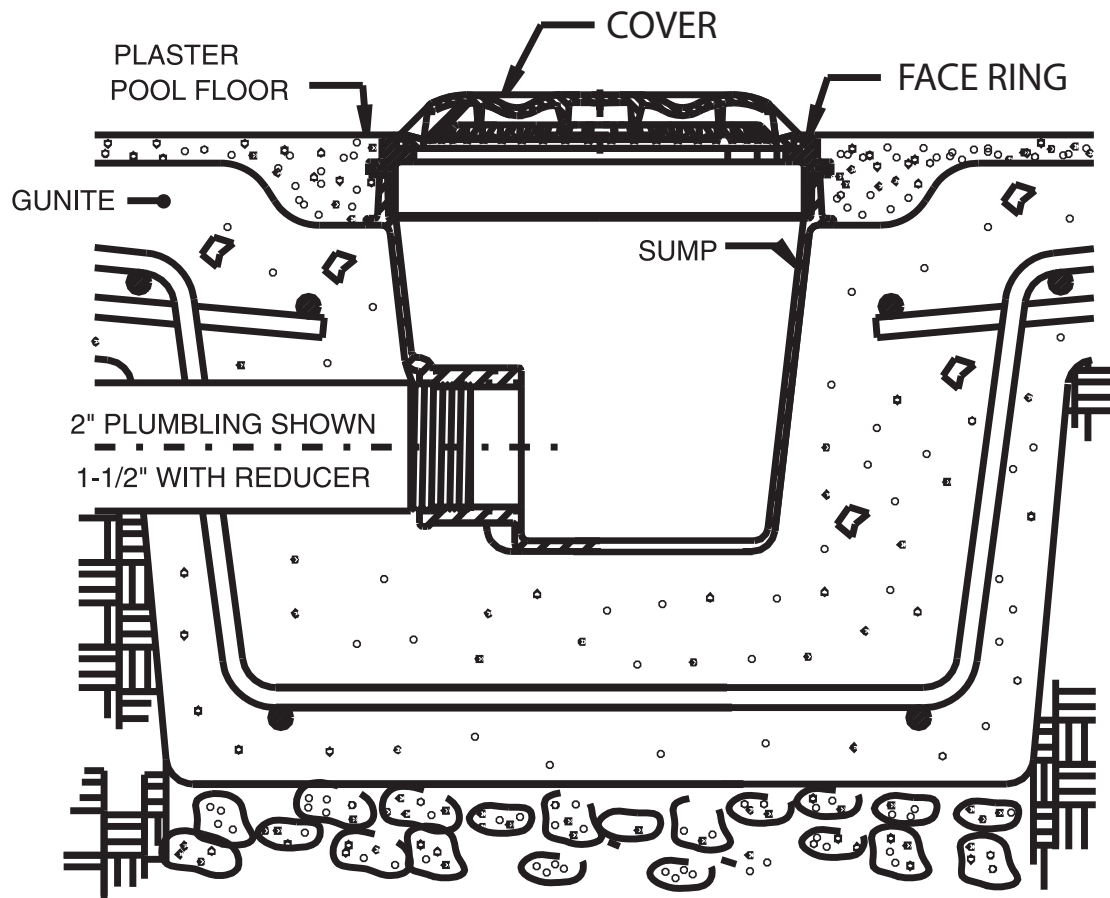

Sump Installation Diagram

The following describes how to install an 8 inch round main drain cover and face ring for the Single Port (2" NPSM Side) drain.

Cover and Face Ring Installation

- ⚠ WARNING** BEFORE INSTALLING THIS PRODUCT, INSTALLERS, POOL OPERATORS AND POOL OWNERS MUST READ AND UNDERSTAND ALL WARNINGS AND SAFETY PRECAUTIONS SET FORTH ON PAGES ii-vii AND PAGES 1-2 OF THIS INSTALLATION GUIDE.

⚠ WARNING ONLY USE THE 316 STAINLESS STEEL 8-32 MACHINE SCREWS PROVIDED. SUBSTITUTE SCREWS SUCH AS MASONRY SCREWS, SHEET ROCK SCREWS OR OTHER TYPES OF SCREWS SHOULD NEVER BE USED, WILL CAUSE THE COVER TO COME LOOSE AND COULD RESULT IN LIMB OR BODY ENTRAPMENT, HAIR ENTANGLEMENT OR EVisCERATION/DISEMBOWELMENT.

⚠ WARNING IF THE FACE RING, SUMP, SCREW OR SCREW HOLES ARE DAMAGED IN ANY WAY THAT PREVENTS COMPLETE INSERTION OF THE SPECIFIED SCREW, THE FACE RING, SUMP OR DAMAGED SCREW MUST BE REPLACED. DO NOT ATTEMPT TO MODIFY OR ALTER ANY COMPONENT IN ANY WAY.
- Install the face ring onto the suction outlet in accordance with: **Section 4, Sump Installation Diagram, page 10.**
- Mount the drain cover on top of the face ring/suction outlet (see Figure 1).
- Rotate the cover to align the screw holes. The cover notch and face ring tab will seat the cover in place.
- Install the two (2) 316 stainless steel 8-32 machine screws (provided) into the holes in the top of the cover. Using a No. 2 Philips head screwdriver, tighten each retaining screw to a **torque value of 10.00 (minimum) to 15.0 (maximum) in/lbs** to secure the cover. **DO NOT OVER TIGHTEN THE SCREWS. DO NOT ASSEMBLE WITH POWER TOOLS.**

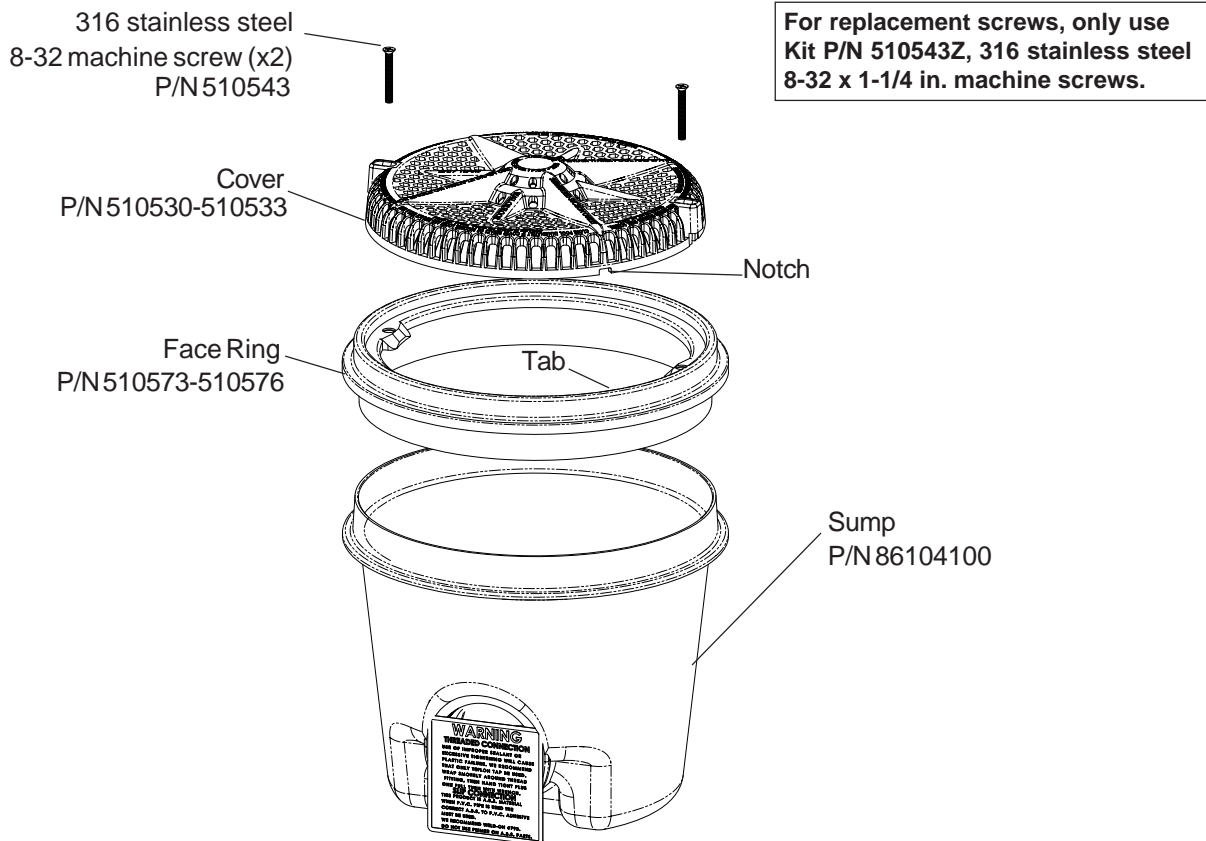

Figure 1

Section 5

StarGuard® 8-inch Round Main Drain Dual Bottom Ports installation

The following describes the installation requirements and procedure for a StarGuard 8 inch round main drain (Dual Bottom Ports).

For the StarGuard 8 inch round main drain new cover and face ring installation, see page 14.

For the StarGuard 8 inch round main drain replacement cover and face ring installation, see page 15.

Model Description

500120 8" MAIN DRAIN, DUAL BOT PORTS ABS SUMP w/ RING AND COVER WHT 2PK

500121 8" MAIN DRAIN, DUAL BOT PORTS ABS SUMP w/ RING AND COVER BLK 2PK

500122 8" MAIN DRAIN, DUAL BOT PORTS ABS SUMP w/ RING AND COVER DG 2PK

500123 8" MAIN DRAIN, DUAL BOT PORTS ABS SUMP w/ RING AND COVER GRY 2PK

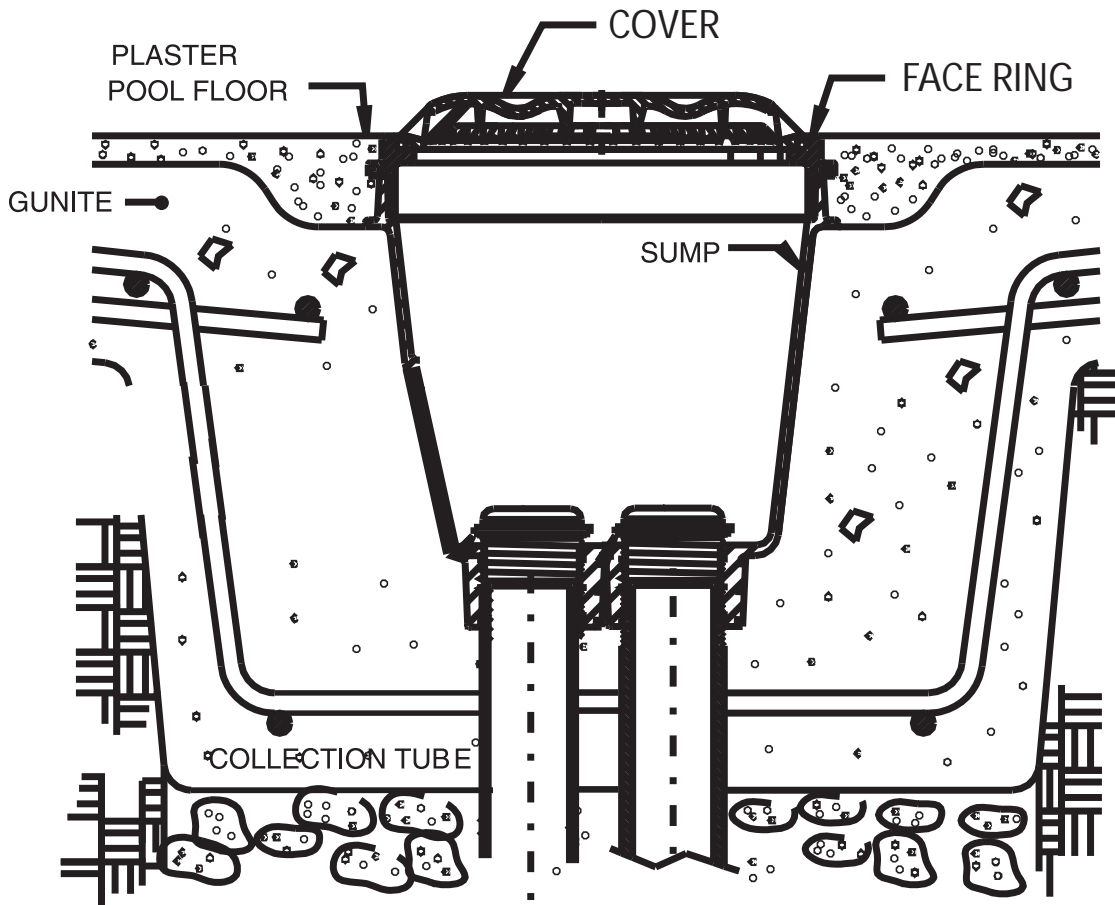

Sump Installation Diagram

New Cover and Face Ring Installation

- ⚠ WARNING** BEFORE INSTALLING THIS PRODUCT, INSTALLERS, POOL OPERATORS AND POOL OWNERS MUST READ AND UNDERSTAND ALL WARNINGS AND SAFETY PRECAUTIONS SET FORTH ON PAGES ii-vii AND PAGES 1-2 OF THIS INSTALLATION GUIDE.

⚠ WARNING ONLY USE THE 316 STAINLESS STEEL 8-32 MACHINE SCREWS PROVIDED. SUBSTITUTE SCREWS SUCH AS MASONRY SCREWS, SHEET ROCK SCREWS OR OTHER TYPES OF SCREWS SHOULD NEVER BE USED, WILL CAUSE THE COVER TO COME LOOSE AND COULD RESULT IN LIMB OR BODY ENTRAPMENT, HAIR ENTANGLEMENT OR EVISCEATION/DISEMBOWELMENT.

⚠ WARNING IF THE FACE RING, SUMP, SCREW OR SCREW HOLES ARE DAMAGED IN ANY WAY THAT PREVENTS COMPLETE INSERTION OF THE SPECIFIED SCREW, THE FACE RING, SUMP OR DAMAGED SCREW MUST BE REPLACED. DO NOT ATTEMPT TO MODIFY OR ALTER ANY COMPONENT IN ANY WAY.
- Install the sump onto the suction outlet in accordance with: **Section 5, Sump Installation Diagram, page 13.**
- Mount the drain cover on top of the sump (see Figure 1).
- Rotate the cover screw holes until it aligns with the brass threaded inserts.
- Install the two (2) 316 stainless steel 8-32 machine screws (provided) into the holes in the top of the cover. Using a No. 2 Philips head screwdriver, tighten each retaining screw to a **torque value of 10.00 (minimum) to 15.0 (maximum) in/lbs** to secure the cover. DO NOT OVER TIGHTEN THE SCREWS. DO NOT ASSEMBLE WITH POWER TOOLS.

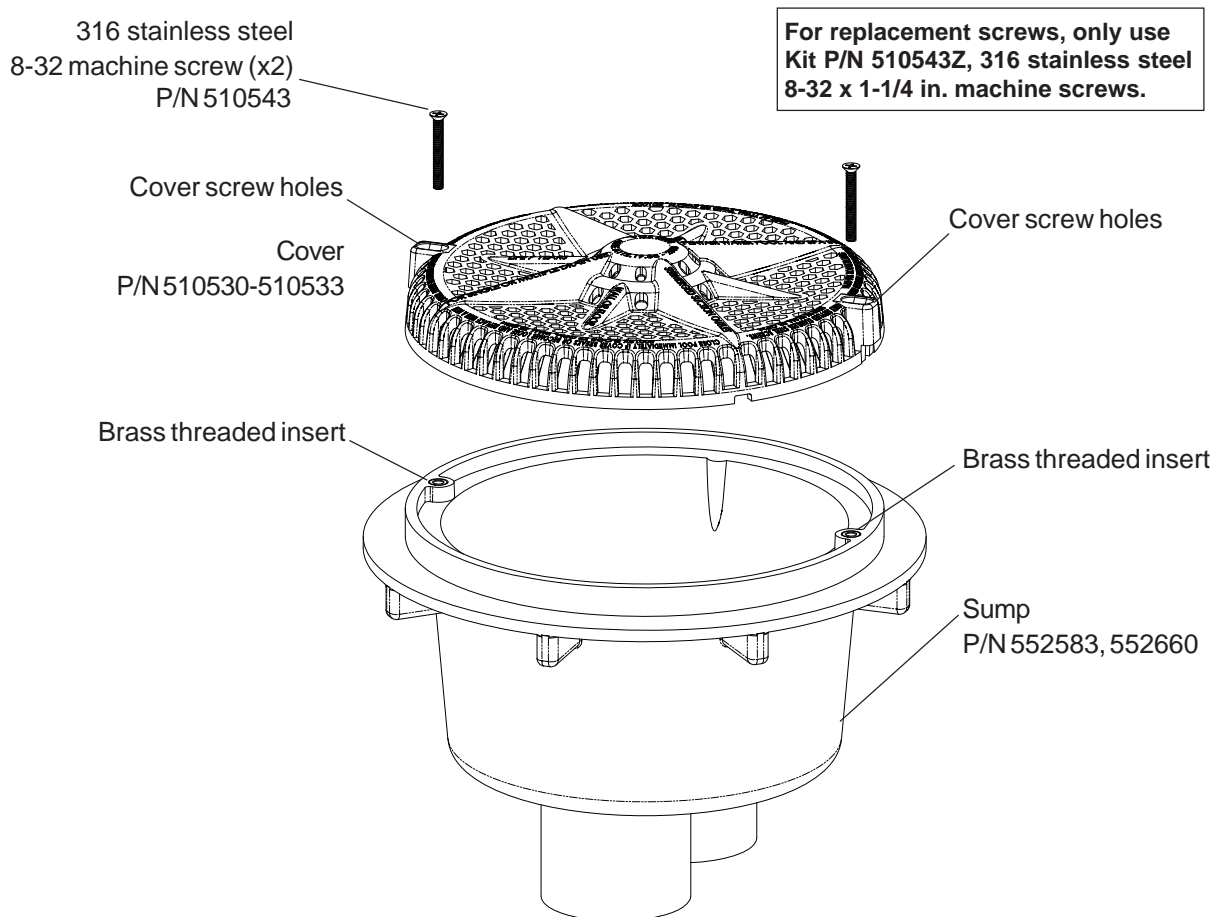

Figure 1

Replacement Cover Installation - StarGuard® 8-inch Round Main Drain (Dual Bottom Ports)

⚠ DANGER Only use replacement thread forming screws (P/N 510583Z) provided in kit, when replacing cover on previously installed dual bottom port drain without brass threaded inserts.

To install the cover:

- ⚠ WARNING** BEFORE INSTALLING THIS PRODUCT, INSTALLERS, POOL OPERATORS AND POOL OWNERS MUST READ AND UNDERSTAND ALL WARNINGS AND SAFETY PRECAUTIONS SET FORTH ON PAGES ii-vii AND PAGES 1-2 OF THIS INSTALLATION GUIDE.

⚠ WARNING ONLY USE THE 316 STAINLESS STEEL 10-14 THREAD FORMING SCREWS (SEE FIG. 1) PROVIDED. SUBSTITUTE SCREWS SUCH AS MASONRY SCREWS, SHEET ROCK SCREWS OR OTHER TYPES OF SCREWS SHOULD NEVER BE USED, WILL CAUSE THE COVER TO COME LOOSE AND COULD RESULT IN LIMB OR BODY ENTRAPMENT, HAIR ENTANGLEMENT OR EVISCERATION/DISEMBOWELMENT.

⚠ WARNING IF THE FACE RING, SUMP, SCREW OR SCREW HOLES ARE DAMAGED IN ANY WAY THAT PREVENTS COMPLETE INSERTION OF THE SPECIFIED SCREW, THE FACE RING, SUMP OR DAMAGED SCREW MUST BE REPLACED. DO NOT ATTEMPT TO MODIFY OR ALTER ANY COMPONENT IN ANY WAY.
- Remove the existing drain cover and discard.
- Mount the drain cover on top of the sump (see Figure 2). Rotate the cover to align the screw holes.
- Install the two (2) 316 stainless steel 8-32 machine screws (provided) into the holes in the top of the cover. Using a No. 2 Philips head screwdriver, tighten each retaining screw to a **torque value of 10.00 (minimum) to 15.0 (maximum) in/lbs** to secure the cover. DO NOT OVER TIGHTEN THE SCREWS. DO NOT ASSEMBLE WITH POWER TOOLS.

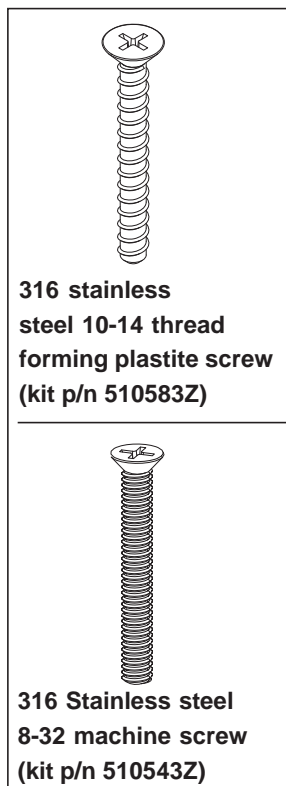
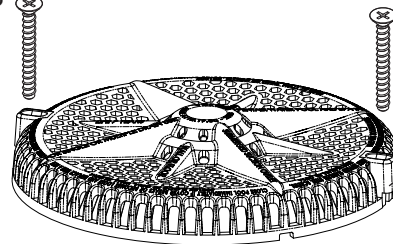

Figure 1

316 stainless steel thread forming screw P/N 510583

Existing screw hole
Sump



Only use thread forming screws. For replacement screws, only use P/N 510583Z (10-14 x 1-1/2 in.) plastite 316 stainless steel screw (Qty. 2).

Cover P/N 510530-510533

Existing screw hole

Sump P/N 552583, 552660

Figure 2

Section 6

StarGuard® 8-inch Round Main Drain Two Port (2" NPSC Side x 1-1/2" NPSC Bottom) Installation for Vinyl Liner Pools (Model 500130)

The following describes the installation requirements and procedure for a StarGuard® 8 inch round main drain (Two Port) for vinyl liner pools.

For the StarGuard® 8 inch round main drain new cover and face ring installation, see page 18.

For the StarGuard® 8 inch round main drain replacement cover and face ring installation, see page 19.

Model	Description
500130	8" MAIN DRAIN VINYL 2 PORT ABS SUMP WHT 2PK

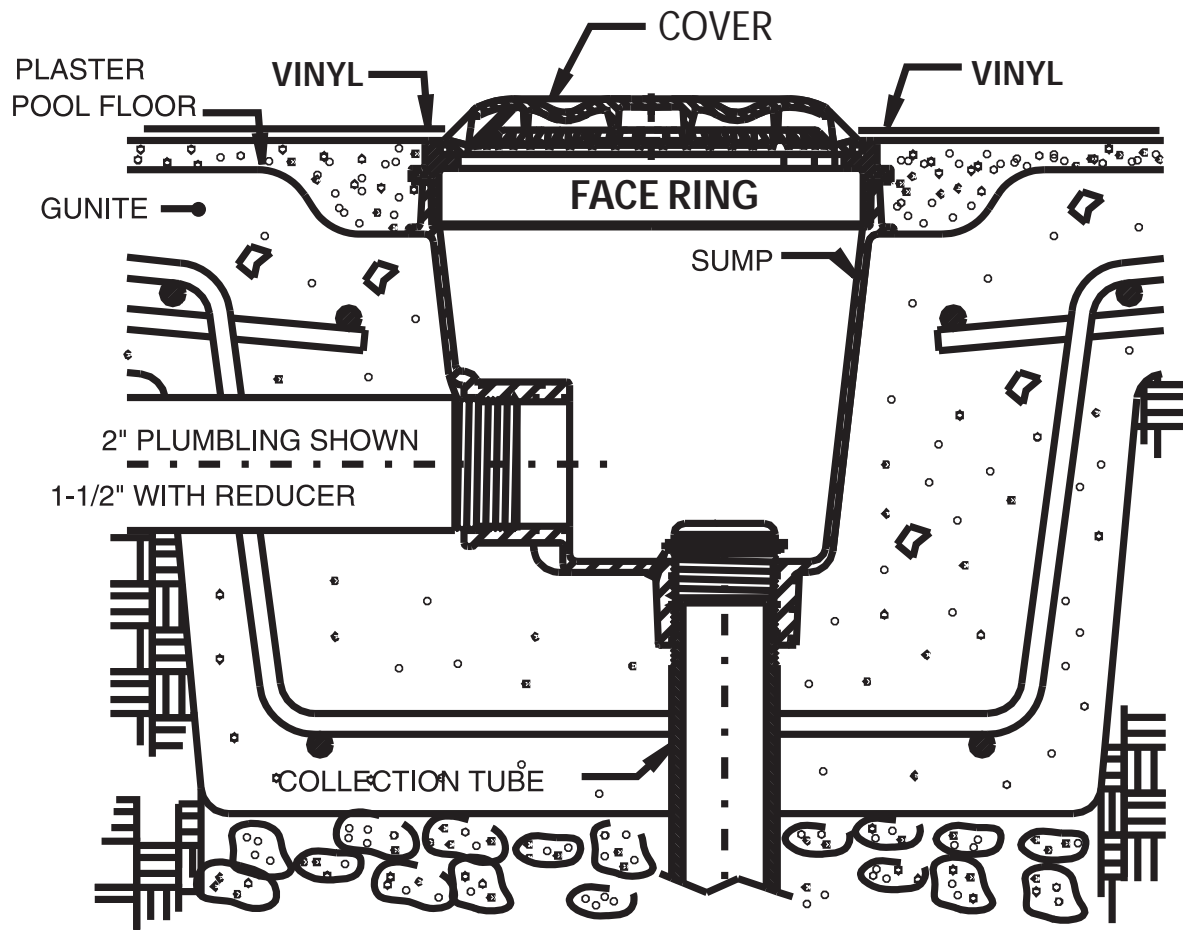

Sump Installation Diagram

Sump Installation for Two Port Drain and Face Ring (Vinyl Liner Pool)

To install the sump, gaskets (2) and face ring:

- ⚠ WARNING** BEFORE INSTALLING THIS PRODUCT, INSTALLERS, POOL OPERATORS AND POOL OWNERS MUST READ AND UNDERSTAND ALL WARNINGS AND SAFETY PRECAUTIONS SET FORTH ON PAGES ii-vii AND PAGES 1-2 OF THIS INSTALLATION GUIDE.

⚠ WARNING ONLY USE THE 316 STAINLESS STEEL 8-32 MACHINE SCREWS (SEE FIG. 1) PROVIDED. SUBSTITUTE SCREWS SUCH AS MASONRY SCREWS, SHEET ROCK SCREWS OR OTHER TYPES OF SCREWS SHOULD NEVER BE USED, WILL CAUSE THE COVER TO COME LOOSE AND COULD RESULT IN LIMB OR BODY ENTRAPMENT, HAIR ENTANGLEMENT OR EVisCERATION/DISEMBOWELMENT.

⚠ WARNING IF THE FACE RING, SUMP, SCREW OR SCREW HOLES ARE DAMAGED IN ANY WAY THAT PREVENTS COMPLETE INSERTION OF THE SPECIFIED SCREW, THE FACE RING, SUMP OR DAMAGED SCREW MUST BE REPLACED. DO NOT ATTEMPT TO MODIFY OR ALTER ANY COMPONENT IN ANY WAY.
- Install the sump onto the suction outlet in accordance with: **Section 6, Sump Installation Diagram, page 17.**
- Install a gasket under and on top of the vinyl liner. Align the gasket and face ring screw holes. Secure the face ring on the top gasket with the eight (8) 316 12-14 x 1" sheet metal self-tapping screws (provided), see Fig. 1. Using a No. 2 Philips head screwdriver, tighten each retaining screw to a **torque value of 10.00 (minimum) to 15.0 (maximum) in-lbs** to secure the face ring and gaskets on the sump. DO NOT OVER TIGHTEN THE SCREWS. DO NOT ASSEMBLE WITH POWER TOOLS.
- Mount the main drain cover on top of the face ring/suction outlet. Rotate the cover until the screw holes are aligned (see Figure 2).
- Install the two (2) 316 stainless steel 8-32 machine screws (provided) into the holes in the top of the cover. Using a No. 2 Philips head screwdriver, tighten each retaining screw to a **torque value of 10.00 (minimum) to 15.0 (maximum) in-lbs** to secure the cover. DO NOT OVER TIGHTEN THE SCREWS. DO NOT ASSEMBLE WITH POWER TOOLS.

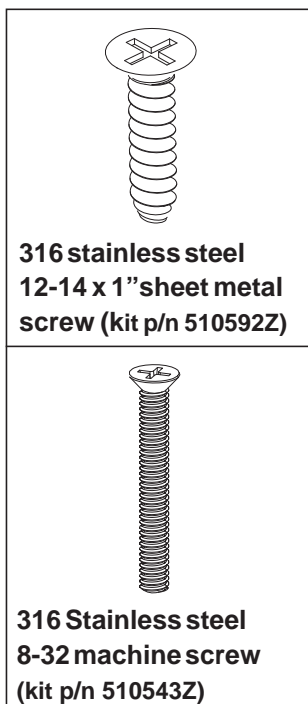

Figure 1



Figure 2

Replacement Cover Installation (For Vinyl Liner Pools)

To install the replacement cover and new face ring:

- ⚠ DANGER** THIS COVER IS NOT COMPATIBLE WITH EXISTING FACE RINGS. BEFORE INSTALLING THIS COVER ON THIS TYPE OF DRAIN, THE EXISTING FACE RING MUST BE REPLACED WITH THE NEW, SUPPLIED FACE RING WITH THREADED INSERTS. NEVER USE AN EXISTING FACE RING OR MERELY ATTEMPT TO REPLACE ONLY THE COVER ON DRAINS OF THIS TYPE. USE OF THIS COVER OTHER THAN WITH THE SUPPLIED FACE RING WITH THREADED INSERTS CAN CAUSE LIMB AND BODY ENTRAPMENT, EVISCERATION/ DISEMBOWELMENT OR HAIR ENTANGLEMENT.

⚠ WARNING BEFORE INSTALLING THIS PRODUCT, INSTALLERS, POOL OPERATORS AND POOL OWNERS MUST READ AND UNDERSTAND ALL WARNINGS AND SAFETY PRECAUTIONS SET FORTH ON PAGES ii-vii AND PAGES 1-2 OF THIS INSTALLATION GUIDE.

⚠ WARNING ONLY USE THE 316 STAINLESS STEEL 8-32 MACHINE SCREWS (SEE FIG. 1) PROVIDED. SUBSTITUTE SCREWS SUCH AS MASONRY SCREWS, SHEET ROCK SCREWS OR OTHER TYPES OF SCREWS SHOULD NEVER BE USED, WILL CAUSE THE COVER TO COME LOOSE AND COULD RESULT IN LIMB OR BODY ENTRAPMENT, HAIR ENTANGLEMENT OR EVISCERATION/DISEMBOWELMENT.

⚠ WARNING IF THE FACE RING, SUMP, SCREW OR SCREW HOLES ARE DAMAGED IN ANY WAY THAT PREVENTS COMPLETE INSERTION OF THE SPECIFIED SCREW, THE FACE RING, SUMP OR DAMAGED SCREW MUST BE REPLACED. DO NOT ATTEMPT TO MODIFY OR ALTER ANY COMPONENT IN ANY WAY.
- Remove the two screws securing the existing cover. Discard the cover and screws.
- Remove the eight (8) face ring screws securing the face ring. Discard the face ring and screws.
- Install the new face ring. Secure with the eight (8) sheet metal self-tapping screws (provided), see Fig. 1. Using a No. 2 Philips head screwdriver, tighten each retaining screw to a **torque value of 10.00 (minimum) to 15.0 (maximum) in-lbs** to secure the face ring. DO NOT OVER TIGHTEN THE SCREWS. DO NOT ASSEMBLE WITH POWER TOOLS.
- Mount the main drain cover on top of the face ring/suction outlet. Rotate the cover until the screw holes are aligned (see Figure 2).
- Install the two (2) 316 stainless steel 8-32 machine screws (provided) into the holes in the top of the cover. Using a No. 2 Philips head screwdriver, tighten each retaining screw to a **torque value of 10.00 (minimum) to 15.0 (maximum) in-lbs** to secure the cover. DO NOT OVER TIGHTEN THE SCREWS. DO NOT ASSEMBLE WITH POWER TOOLS.

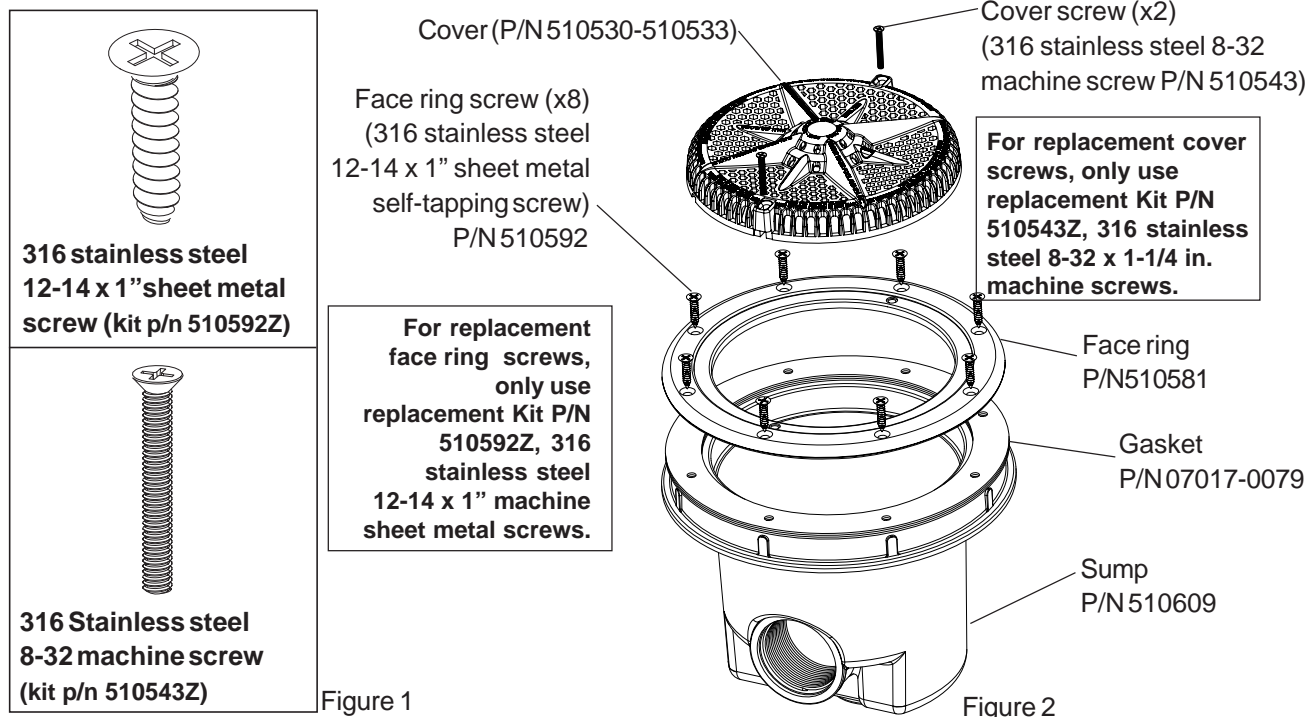

Blank Page

Blank Page

Blank Page

CERTIFICATION OF COMPLIANCE

Pentair Water Pool and Spa Inc., 1620 Hawkins Ave., Sanford, NC 27330, (800) 831-7133, hereby certifies that the following model numbers meet or exceed the requirements of Section 1404 of the Virginia Graeme Baker Act Pool & Spa Safety Act, VGB 2008 and ANSI/APSP-16 2011 standards and safety regulations as set forth by the Consumer Products Safety Commission:

CHART 1			
Part No.	Open Area	Flow Rating Floor	Flow Rating Wall
50010X	15.35 in ²	144 GPM	112 GPM
50011X	15.35 in ²	144 GPM	112 GPM
50012X	15.35 in ²	144 GPM	112 GPM
50013X	15.35 in ²	144 GPM	112 GPM

IAPMO Certified

These products were tested and certified to the aforementioned safety regulations, by IAPMO Research and Testing, 5001 E. Philadelphia St. Ontario, CA 91761 – USA 877-4UPCMARK (toll free)

Product certification commenced April 2009, test results can be obtained from: www.pentairwater.com and/or <http://pld.iapmo.org/>

Each product contains a circular date stamp on the top or bottom of the product showing the month and year of manufacture. These products are manufactured at Pentair Water Pool and Spa, Inc., Chino, California in the United States of America.

A copy of this certificate is available on the Pentair Water Pool and Spa Inc. website: www.pentairpool.com

Note to installer/owner:

Enter the information below: Please keep this page as a record of the installation date.

Date of Installation: _____





1620 HAWKINS AVE., SANFORD, NC 27330 • (919) 566-8000
10951 WEST LOS ANGELES AVE., MOORPARK, CA 93021 • (805) 553-5000

www.pentairpool.com

All Pentair trademarks and logos are owned by Pentair or by one of its global affiliates. Pentair Aquatic Systems™, StarGuard®, IntelliFlo®, Pentair Pool Products®, and American Products® are trademarks and/or registered trademarks of Pentair Water Pool and Spa, Inc. and/or its affiliated companies in the United States and/or other countries. Unless expressly noted, names and brands of third parties that may be used in this document are not used to indicate an affiliation or endorsement between the owners of these names and brands and Pentair Water Pool and Spa, Inc. Those names and brands may be the trademarks or registered trademarks of those third parties. Because we are continuously improving our products and services, Pentair reserves the right to change specifications without prior notice. Pentair is an equal opportunity employer.

© 2015 Pentair Water Pool and Spa, Inc. All rights reserved. This document is subject to change without notice.

