



# COMMERCIAL INTELLICHEM<sup>®</sup> WATER CHEMISTRY CONTROLLER



## INSTALLATION AND USER'S GUIDE

IMPORTANT SAFETY INSTRUCTIONS  
*READ AND FOLLOW ALL INSTRUCTIONS*  
SAVE THESE INSTRUCTIONS

## Contents

<b>IMPORTANT WARNING AND SAFETY INSTRUCTIONS.....</b>	<b>i-iv</b>
Overview.....	1
Operator Controls Indicators and Alarm LEDs.....	3
pH Settings and ORP Settings Buttons.....	4
IntelliChem Controller System Power Up Sequence.....	5
Password Protect.....	6
Display Modes.....	7
Auto Setup Sequence.....	7
IntelliChem Controller System Default Values.....	10
IntelliChem Controller Menus.....	11
Navigating IntelliChem Controller Menus.....	12
pH Menu Description.....	13
ORP Menu Description.....	16
Configuration Menu.....	19/27
Auto Setup Menu.....	28
Saturation Index Overview.....	28
<b>INSTALLATION.....</b>	<b>32</b>
Mounting IntelliChem Controller Enclosure.....	33
Wiring the IntelliChem Controller Transformer.....	33
Connecting Commercial and Residential IntelliChlor SCG.....	34
Installing the Flow Cell and pH/ORP Sensors.....	35
Plumbing the Flow Cell.....	37
Connecting Sensor Wires.....	40
Connecting the IntelliChem Controller to an Automation Control System.....	41
Wiring the IntelliChem Controller AC Power to Automation Filter Pump Relay.....	43
Setting up EasyTouch, IntelliTouch, SunTouch Automation Control System.....	44
Troubleshooting.....	47
Tweaking pH/ORP (Calibrating Sensors).....	52
Maintenance / Stenner Pump Head Maintenance.....	54
Replacement Parts List.....	55
Connecting Remotely to the IntelliChem Controller.....	58
ScreenLogic2 Wireless connection Kit.....	59
ScreenLogic2 Interface Connection Troubleshooting Hints.....	61
Normal Operation.....	62



## IMPORTANT WARNING AND SAFETY INSTRUCTIONS

**⚠ DANGER** SERIOUS BODILY INJURY OR DEATH CAN RESULT IF THIS PRODUCT IS NOT INSTALLED AND USED CORRECTLY.

**⚠ DANGER** INSTALLERS, POOL OPERATORS AND POOL OWNERS MUST READ THESE WARNINGS AND ALL INSTRUCTIONS BEFORE USING THIS PRODUCT.

**⚠ WARNING** Most states and local codes regulate the construction, installation, and operation of public pools and spas, and the construction of residential pools and spas. It is important to comply with these codes, many of which directly regulate the installation and use of this product. Consult your local building and health codes for more information.



**IMPORTANT NOTICE - Attention Installer:** This Installation and User's Guide ("Guide") contains important information about the installation, operation and safe use of this product. This Guide should be given to the owner and/or operator of this product.

**⚠ WARNING** Before installing this product, read and follow all warning notices and instructions in this Guide. Failure to follow warnings and instructions can result in severe injury, death, or property damage. Call (800) 831-7133 for additional free copies of these instructions. Please refer to [www.pentairpool.com](http://www.pentairpool.com) for more information related to this products.

**DO NOT INSTALL THE INTELLICHEM® CHEMICAL CONTROLLER WHERE IT CAN BE ACCESSIBLE TO THE PUBLIC.**

**⚠ DANGER**



**RISK OF ELECTRICAL SHOCK OR ELECTROCUTION:**

Before working on the IntelliChem® Chemical Controller always disconnect power to the IntelliChem controller at the circuit breaker before servicing. Failure to do so could result in death or serious injury to service person, pool users or others due to electric shock.

BE SURE TO DISCONNECT ALL SUPPLY CONNECTIONS BEFORE SERVICING THE INTELLICHEM CONTROLLER. AC Power may be supplied to the relay terminals Ex\_Relay1 and Ex\_Relay2 from other sources. See page 34 for details.

This product must be installed by a licensed or certified electrician or a qualified pool professional in accordance with the National Electrical Code (NEC), NFPA 70 or the Canadian Electrical Code (CEC), CSA C22.2. All applicable local installation codes and ordinances must also be adhered to. Improper installation will create an electrical hazard which could result in death or serious injury to pool users, installers or others due to electrical shock, and may also cause damage to property.

**⚠ WARNING** BEFORE USING YOUR POOL, SPA OR HOT TUB, CHECK THE pH AND SANITIZER LEVELS OF THE WATER.

**⚠ WARNING** Do not permit children to operate this equipment.

**⚠ WARNING** When mixing acid with water, ALWAYS ADD ACID TO WATER. NEVER ADD WATER TO ACID. When adding any chemical to the pool/spa, be sure to follow the manufacturer's instructions thoroughly.

**⚠ WARNING** DO NOT MIX SODIUM HYPOCHLORITE AND MURATIC ACID

**⚠ WARNING** Risk of electrical shock. Connect the IntelliChem Controller to a ground-fault interrupter-circuit (GFCI). Contact a qualified electrician if you cannot verify that the receptacle is protected by a GFCI.

**⚠ WARNING** IF "CLEAR OVERFEED LIMIT" SETTING IS SET TO 24 HOURS, DO NOT SET "FEED TIME" GREATER THAN 20 HOURS AS THIS WILL VOID NSF CERTIFICATION.

## IMPORTANT WARNING AND SAFETY INSTRUCTIONS

**⚠ WARNING** **WARNING CHEMICAL BURN HAZARD:** Make sure all pumps are switched off at the main circuit breakers at the house before drilling into any pipes. Securely fasten all electrical, water and chemical lines. Locate chemical feed pumps and chemical storage tanks in a safe and secure area.

**⚠ WARNING** Strictly follow the acid manufacturers safety and handling protocols including hand, body and eye protection when transferring or handling acid. Safety precautions should be used when handling Muriatic acid to control pH water levels. Muriatic acid can cause serious body injury and damage pool equipment. Extra care must be taken when installing, maintaining and operating acid pump feed systems. Acid is dangerous to handle and should be properly contained, transported, poured, stored, and dispensed.

### ⚠ WARNING

- Check the pH and sanitizer levels of the water before use.
- Periodically use an independent pH and Chlorine test kit to verify that pH and chlorine is at a safe level. If the pH and Oxidation Reduction Potential (ORP) or Flow Cell sensors are broken, depleted or dirty with oils, lotions, or other contaminants, they can report inaccurate results to the system causing incorrect water chemistry, which could harm people or equipment.
- Check the IntelliChem® Controller main status display each day to ensure there are no Alarm messages. See “Troubleshooting” on page 47 for more information.

**When using Commercial IntelliChem® with a pool pump timer:** The Association of Pool and Spa Professionals (APSP) recommends that all water in a commercial pool pass through the filtration system at least once every 6 hours (referred to as pool water turnover). However, many factors have an effect on actual pump and filter system run times. Pool size, source of water, direct sun light, indoor/outdoor, screened and unscreened, filtration system, cold or hot weather, swimmer load, rain, organic debris, algae, etc., are all factors which contribute to either more or less pool pump and filter system run times. Because of these differences, it is extremely difficult to set an initial run time (starting point) for the pool pump and chlorinating system. Try initially setting the pool pump timer to 6 hours. It will take a few days to get just the right amount pool pump operating time. When the Chlorinator is wired with a pool pump timer (see Configuration Menu, page 19) results will vary greatly from one pool installation to the next, so this should be discussed with either the pool builder or your pool professional.

### Using CO2 for pH Control

Plaster pools and pools using salt-chlorine generators typically cause a slow pH rise which must be managed. With the IntelliChem® controller muriatic acid or carbon dioxide (CO2) is dispensed into the filter system's return water as needed until the Flow Cell pH sensor detects the proper pH level. Using CO2 for pH control eliminates the need to handle and stored acid and can be a safer method. As CO2 gas is injected into the pool water, it dissolves and creates carbonic acid. This weak acid is very efficient at lowering pH with the added benefit of self-limiting if the CO2 is over-fed.

## IMPORTANT WARNING AND SAFETY INSTRUCTIONS

**WARNING** Most states and local codes regulate the construction, installation, and operation of public pools and spas, and the construction of residential pools and spas. It is important to comply with these codes, many of which directly regulate the installation and use of this product. Consult your local building and health codes for more information.



**IMPORTANT NOTICE - Attention Installer:** This Installation and User's Guide ("Guide") contains important information about the installation, operation and safe use of this product. This Guide should be given to the owner and/or operator of this equipment.

**WARNING** Before installing this product, read and follow all warning notices and instructions in this Guide. Failure to follow warnings and instructions can result in severe injury, death, or property damage. Call (800) 831-7133 for additional free copies of these instructions. Please refer to [www.pentairpool.com](http://www.pentairpool.com) for more information related to this products.

**WARNING** Working with muriatic acid can be dangerous. When cleaning the IECG always wear rubber gloves and eye protection. Always add acid to water, do not add water to acid. Always work in a well-ventilated area. Splashing or spilling acid can cause severe personal injury and/or property damage. **Pentair always recommends 1:1 dilution when using full strength muriatic acid. When mixing, remember to always add acid to water.**

**IMPORTANT! TAKE EXTREME CARE WHEN INSERTING THE ACID CONTAINER INTO THE STORAGE TANK, AS THE FOIL SEAL MAY NOT BE FULLY ATTACHED.**

**WARNING** Be sure that the pool or spa meets the requirements of the current National Electrical Code (N.E.C.) Article 680-22 and all local codes and ordinances. A licensed or certified electrician must install the electrical system to meet or exceed those requirements before the underwater light is installed.

**DANGER**



**READ THE FOLLOWING BEFORE HANDLING AND WORKING WITH MURIATIC ACID (ALSO KNOWN AS HYDROCHLORIC ACID) AND CHLORINE (SODIUM HYPOCHLORITE)**

MURIATIC ACID AND CHLORINE (LIQUID AND MIST) CAN CAUSE SEVERE BURNS TO SKIN, MOUTH AND EYES. MAY BE FATAL IF SWALLOWED OR INHALED. INHALATION CAN CAUSE SEVERE LUNG DAMAGE.

**IMPORTANT! CHLORINE CONTAINER**

MIXING CHEMICALS WITH CHLORINE OR CHLORINE RESIDUE IN CONTAINER CAN CREATE A DEADLY GAS OR AN EXPLOSION.

## IMPORTANT WARNING AND SAFETY INSTRUCTIONS



### **INHALATION**

Inhalation of vapors can cause coughing, inflammation of the nose, throat and upper respiratory tract and death. In case of inhalation, move to an area of fresh air immediately.

### **INGESTION**

Swallowing can be fatal. Contact local poison control center or physician immediately. Give large amounts of water or milk. Allow person to vomit. If vomiting occurs, keep head lower than hips to avoid aspiration. If person is unconscious, turn their head to the side. Seek immediate medical attention.

### **STORAGE:**

Install and store container and acid in a dry, ventilated place protected from excess heat and direct sunlight. Should be stored at a temperature below 80°F (27°C). Be sure drainage is located away from building and equipment.

### **SKIN CONTACT**

Wash skin with soap and water for at least 20 minutes and remove contaminated clothing and shoes. Contaminated clothes should be thoroughly cleaned before re-use.

### **EYE CONTACT**

Flush eyes immediately with water for at least 20 minutes. Seek immediate medical attention.

### **PERSONAL PROTECTION**

#### **VENTILATION**

Use container outside and in a well-ventilated area.

#### **EYE PROTECTION**

Use splash-resistant safety goggles.

#### **CLOTHING**

Wear chemical-resistant clothing when handling or working with acid and chlorine.

#### **GLOVES**

Wear chemical-resistant gloves when handling or working with acid and chlorine.

#### **DISPOSAL**

Because of its corrosive nature, muriatic acid is a hazardous waste when spilled or discarded. Dispose of used acid at an approved hazardous waste facility or at your municipal household hazardous waste collection facility. Small spills of acid may be neutralized using baking soda. Carefully pour the baking soda onto the spilled material until the fizzing stops, then mop or scoop up the residue. Leave cleanup of large spills to the experts; call your local fire department or hazardous materials spill team.

**READ AND FOLLOW ALL INSTRUCTIONS  
SAVE THESE INSTRUCTIONS**

## Overview

The COMMERCIAL INTELLICHEM® Water Chemistry Controller is a pH and ORP sensing device that dispenses correct amount of chlorine or bromine, muriatic acid or CO2 gas. The IntelliChem controller provides continual analysis of your swimming pool water sanitation and pH levels, providing real-time status information to dispense the proper amount of muriatic acid (pH reducer) and chlorine or bromine for the correct sanitization and pH balance. The IntelliChem controller operates with or without a salt chlorine generator to provide a self-replenishing supply of chlorine generated from salt. The IntelliChem controller can also connect to carbon dioxide (CO2) liquid gas tanks to lower pH in your swimming pool water. When CO2 dissolves into water it produces weak neutral bicarbonate salts which reduces pH. CO2 is environmentally friendly and produces no secondary pollution into the treated water by salts such as chlorides or sulfates. CO2 does not corrode metal equipment and does not require any special piping. In Dual Sanitization mode the primary sanitizer can be configured as either the IntelliChlor or the dry contacts of add-on Relay3 to enable the COMSYS unit. Backup sanitization is provided using a liquid doser on Ex\_Relay1. The IntelliChem controller also supports IntelliChlor® Salt Chlorine Generator (SCG) to help manage your pool water sanitizer levels.

### Dual Sanitizer Operation

The IntelliChem Controller provides a Dual Sanitizer ORP feature, which provides a backup for the standard ORP acid feed pumps. The ORP menu “Dual Bkup” sets the threshold below the setpoint when the EX\_RELAY1 will start feeding. It is adjustable from 0 to 50mV (default=20mV).

### Connecting Remotely to the IntelliChem Controller

Using the ScreenLogic Interface you can control your pool and spa operations remotely from your laptop computer over the Internet or from your local networked computer in your house. You can download the latest remote ScreenLogic software from [www.pentairpool.com](http://www.pentairpool.com). For more information, see page 58.

## Operating the Commercial IntelliChem® Controller

Before operating the Commercial IntelliChem controller, it's important to test and adjust your pool water chemistry to the recommended pool industry levels found in this manual (see page 30). If you are using an IntelliChlor salt chlorine generator, adjust the salt levels to the recommended levels in the IntelliChlor (SCG) Installation and User's Guide (P/N 520589). During normal operation, no user input is required, the Commercial IntelliChem controller will automatically sense ORP and pH levels. The current ORP and pH levels are regularly displayed on the control panel LCD display. Use the pH Settings or ORP Settings buttons to view or adjust supply levels. The "Auto Setup" feature provides screen prompts for first-time setup or standard configurations such as setup reminder times, calculating feed times, proportional limits and alarms. For details, see page 7.

### First Balance Your Pool Water

**IMPORTANT:** To help keep your pool water balanced follow these steps:

1. Use a Test Kit (with fresh testing reagents) to measure the **pH, alkalinity, and calcium** hardness of the pool water. For greater accuracy, Pentair recommends the AcuCheck3 Test Kit to measure pH, chlorine ppm, and alkalinity levels (P/N 745000110). "Balanced" water has proper levels of pH, Total Alkalinity and Calcium Hardness. This "balanced" water is neither corrosive or scaling. The pH (0-14) value is the scale of relative acidity or alkalinity. Recommended pH range is from 7.2 to 7.6. The IntelliChem controller default pH value is 7.5 (see page 14).
2. Be sure the pool chlorine level is balanced. Ideal free chlorine level should be between 1.0 - 3.0 parts per million (ppm).
3. Use the online **Langelier Saturation Index (LSI)** calculator to diagnose the water balance in your pool or the IntelliChem controller built-in LSI calculator (see page 28-31). Refer to:  
<http://www.pentairpool.com/pool-owner/resources/calculators/langelier/>

*Note: A Saturation Index value of 0 indicates the water is chemically in balance. If the Index is a **minus (-) value, corrosive tendencies are indicated.** If the Index is a **plus (+) value, scale-forming tendencies are indicated.** A Saturation Index value between **+0.5 to -0.5** is considered satisfactory in a swimming pool. See Saturation Index menu on page 28.*



## Operator Controls, Indicator and Alarm LEDs

### Control Panel Description

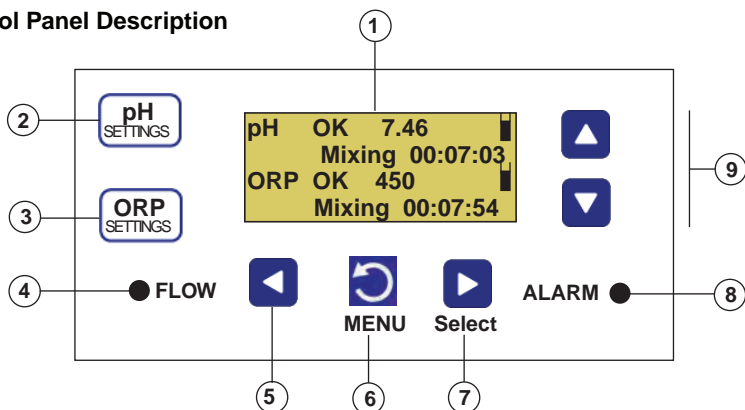

### Control Buttons and LEDs:

- ① **Liquid Crystal Display (LCD) with backlighting:** Displays system status information and the IntelliChem® Controller main menu. Display backlight and menu on and off time (30 seconds to 24 hours) can be set via the “LCD Timeout” menu feature. See “Configuration” menu page 19).  
**Display viewing modes:** Select between two display modes: **Basic:** pH and ORP status with alarms messages. **Advanced:** pH, ORP, status, alarm messages and process timers.
- ② **pH Settings button:** Access the pH settings (see page 4).
- ③ **ORP Settings button:** Access the Oxidation Reduction Potential (ORP) settings (see page 4).
- ④ **Flow LED:** Green LED on indicates flow is detected. LED will blink during flow delay. LED off indicates no flow in the system. If flow is not present, no chemical feeding or IntelliChem controller activity is allowed. LED brightness can be adjusted via the Configuration “Display Modes” menu (see page 7).
- ⑤ **Left arrow button:** Scroll through sub-menu items or move cursor left when editing a setting.
- ⑥ **Menu button:** Access the main menu (see page 11). While in menu mode, used to exit a menu level. All items are saved as soon as they are changed.
- ⑦ **Right arrow button:** When in menu mode, selects menu main and sub-menu item, scroll through sub-menu items or move cursor right when editing a setting.
- ⑧ **Alarm LED:** LED is on if an alarm condition occurs. Display shows alarm message and status (see page 49). LED brightness can be adjusted via the Configuration “Display Modes” menu (see page 7).
- ⑨ **Up/Down arrow button:** When in a menu mode, use ▼/▲ to scroll through main menu and sub-menu items, increase, decrease or change a setting or value. Also, used for moving to next sub-menu page 1/2 - 2/2.

## pH Settings and ORP Settings Buttons

### pH Dosage (dispense acid)



DO NOT manually feed pH (acid) and ORP sanitizer (chlorine) at the same time without sufficient water flow through the piping system. Combining these two chemicals without sufficient water flow for mixing will result in the formation of hazardous gas. This menu item will be displayed as **Override [Wait]** during no-flow and flow-delay time period.



**pH Settings button:** Press the **pH Settings button** to access the pH dosage settings.

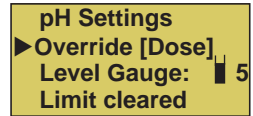

**ORP Settings button:** Press the **ORP Settings button** to access the Oxidation Reduction Potential (ORP) settings. The ORP is the sanitization quality of the water of a given solution.

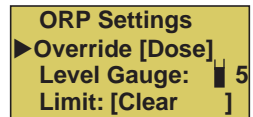

Note: To exit pH Settings and ORP Settings, press the MENU button.

**Password Protect:** The pH Settings and ORP Settings screens are not accessible when the Password Lock is set to "ALL". Set the Password Lock to "OFF" or "MENU" to access these screens (see page 6).

**Override (pH):** Press the **◀/▶ Right or Left arrow button** to toggle between "Dose" or "Stop". Select "Dose" to dispense muriatic acid or CO<sub>2</sub> and select "Stop" to stop dispensing acid or CO<sub>2</sub> (pH Settings LED is on). To exit, press the MENU button or press the **▼ Down button** to select the "Level Gauge" feature. The Override feature is not available when CO<sub>2</sub> is setup to "Feed to Setpoint."

**Override (ORP):** Press the **◀/▶ Right or Left arrow button** to toggle between "Dose" or "Stop". Select "Dose" to dispense chlorine (or bromine) and select "Stop" to stop dispensing chlorine (ORP Settings LED is on). To exit, press the MENU button or press the **▼ Down button** to select the "Level Gauge" feature. The Override feature is not available when IntelliChlor is setup to "Feed to Setpoint."

**Level Gauge indicator:** Press the **▼/▲ Up/Down button** to select this feature. The level gauge (volume based) and hour glass (time based) icon is a visual representation of the amount of acid (pH Settings) or chlorine (ORP Settings) available in the container. Press **◀/▶** six times to fill the gauge (container full). The indicator displays six horizontal bars when full. The level gauge is not available if the doser is unable to determine the pump dispense rate, the supply volume, or if there is no supply "reminder" set up (see page 14-17). The gauge is displayed as an "hour glass" if the supply is based on time rather than volume (see page 7)

**Limit [Clear]:** Press the **▼/▲** to select this feature. Press the **◀/▶** to clear the current dosage limit timer. After pressing the button, "CLEARED" is displayed, indicating that the current dosage limit is cleared.

## IntelliChem® Controller System Power Up Sequence

IntelliChem® Controller  
v2.008 4/24/2017  
Pentair Aquatic  
Systems

**AUTO CALIBRATION**

**AUTO CALIBRATION**  
pH 6.35 7.65 OK  
ORP 738 398 OK  
\*\*\*PASSED\*\*\*

IntelliChem Auto  
Setup Wizard  
Press MENU to go  
to each new step

Awaiting  
**POWER&FLOW DELAY**  
H:00 M:14 S:18  
please wait...

pH OK 7.5  
ORP OK 450

**Power-up Sequence:** During power-up the Commercial IntelliChem® Controller displays the initialization screens before the main status screen is displayed. During this initial power up sequence, the IntelliChem controller performs an internal self test and continues with a system calibration. The first screen includes the current software version and date.

AUTO CALIBRATION is displayed each time IntelliChem is powered up.

In the next auto-calibration sequence the pH and ORP meters are tested with on-board circuitry and calibrated to the built-in reference devices. An out-of-tolerance condition is immediately reported as an error so the user can have the unit serviced.

The very first time IntelliChem controller is powered up and after a factory reset, the **Auto Setup Wizard** start screen is displayed. Otherwise access the wizard from the main menu (see page 7).

The normal start up screen will simply be this one, awaiting Power On & Flow Delay. The countdown timer shows the remaining time before the unit starts reading the probes and controlling the doser.

**Main Status Screen:** After IntelliChem controller has completed the Flow Delay the main status screen displays the measurements of the connected pH and ORP sensors.

## Set Password Protect

The password protect feature prevents access to certain menus and prohibits all menu changes and manual feeds. For more information, see Set Password on page 20. To set the password protect:

Set Password	
PW	[1234]
Lock	[Off ]

Locked - Please enter password
> 1234

1. Press MENU ▼/▲ Configuration ► and ▼/▲ Set Password.
2. **Set Password (PW):** Press the ▼/▲ **Up/Down arrow button** to select the first password digit (0-9).
3. Press the ◀/▶ **Right/Left arrow button** to move the cursor to the next digit.
4. Press the ▼/▲ **Up/Down arrow button** to select the second password digit. Repeat steps 3 and 4 for the third and fourth password digit.
5. Press the ▶ **Right arrow button** to move the cursor to the **Lock Menu** setting.
6. Press the ▼/▲ **Up/Down arrow button** to select **OFF**: Do not enable control panel button lockout. **ALL**: Lockout MENU, pH Settings and ORP Settings buttons). Tank Levels cannot be changed. **MENU**: Lockout MENU button (not pH Settings and ORP Settings buttons). Setpoints or Sat Index values TA, CYA, CH cannot be changed.
7. To exit, press the MENU button (press three times to return to the main screen).

**Tip:** Setting the password 0000 allows you to enter a protected screen by pressing MENU. Also, once the password is entered, access is granted for the duration specified by the Menu timeout setting in the Configuration/Display Mode menu (see page 19).

## Password Protect and IntelliTouch®, EasyTouch® and SunTouch® Control Systems

**Note:** If the password lock is enabled from Commercial IntelliChem controller it will also be locked out on the IntelliTouch, EasyTouch or SunTouch control system.

When Commercial IntelliChem is controlled by the IntelliTouch, EasyTouch or SunTouch control system, if the password is set and locked on the Commercial IntelliChem controller, **it cannot be changed** from the automation control panel. **To change** a “LOCKED” password from the automation system, enter the password on the Commercial IntelliChem controller, it will remain active for the Menu Timeout MM:SS period. During that time, the automation system will be able to set the appropriate settings, just as you would from the Commercial IntelliChem controller front panel. Receiving updated settings from automation will continue to extend the Menu Timeout, just as if you’re accessing the menu on the Commercial IntelliChem controller itself.

## Display Modes

The main Commercial IntelliChem® Controller status screen can be setup to display basic or advanced system information. To setup the Display Mode, see “Configuration” menu on page 19. The **Basic** display mode shows the current pH and ORP measurements including a message describing any existing pH (line two) and ORP (line four) alarms. The **Advanced** display mode shows all the current measurements and alarm messages as well as dose and mix timers showing the progress of those processes.

### Basic display mode

pH >OK 7.4  
-72 Scaling  
ORP OK 730  
Monitoring

The Basic mode displays the current pH and ORP measurements (pH in 10th and ORP in 5mV) with any alarms and tank levels if enabled.

Note: Alarms are displayed on all Basic and Advanced modes.

>OK or <OK is displayed as soon as the value exceeds alarm trip point. That is replaced with “HIGH/LOW” after the specific alarm delay time period.

### Advanced display mode

pH HIGH 7.91  
pH Dose Limit  
ORP OK 683  
Mixing 00:07:54

Displays three different Alarms. The example screen shows: Dose limit, high reading and chemical tank low alarm. These can co-exist. The advanced mode displays the current pH and ORP high precision measurements (extra digit. e.g. pH=100th - ORP=1mV resolution), alarms, tank levels, process messages and timers.

### Basic and Advanced Display with Error Messages

NO FLOW DETECTED  
Check pump, flow  
Cell, filter,

If IntelliChem detects the pool water circulation pump is not active, a NO FLOW message is displayed. ORP and pH values are not measured when there is no flow, and therefore not displayed.

## Auto Setup Sequence

Use the Auto Setup feature for first-time setup or standard configurations. Follow the on-screen prompts and enter information about your system configuration (pH/ORP internal or external pumps, pool size, filter time, chemical container size etc). IntelliChem uses this information to automatically setup reminder times, calculate feed times, proportional limits and alarms. The following describes the Auto Setup screen. Press the **MENU button** to access the Auto Setup menu. To change a menu setting or value press the **▼/▲ Up/Down arrow button**. Press the MENU button to save each selection.

Press **MENU ▼/▲ Auto Setup ►**

**Previous Values:** Use to recalculate new dose times etc., if no custom settings exist. Not recommended for custom settings; use the menu directly to make these changes.

**Reset All:** Make major configuration changes that may have conflicts with previous settings.

IntelliChem Auto  
Setup Wizard  
Press MENU to go to  
each new step

To exit Auto Setup,  
press ◀

Dosing will  
resume when you  
exit this menu  
Press any button

Would you  
like to use  
previous values?  
[Yes | Reset All]

Press UP/DWN to select.  
Press MENU. (Resetting  
defaults and Password).  
Press MENU.

## Auto Setup Sequence (Continued)

Press the ▼/▲ **Up/Down arrow button** to scroll through the controller configurations.  
Press the MENU select next screen.

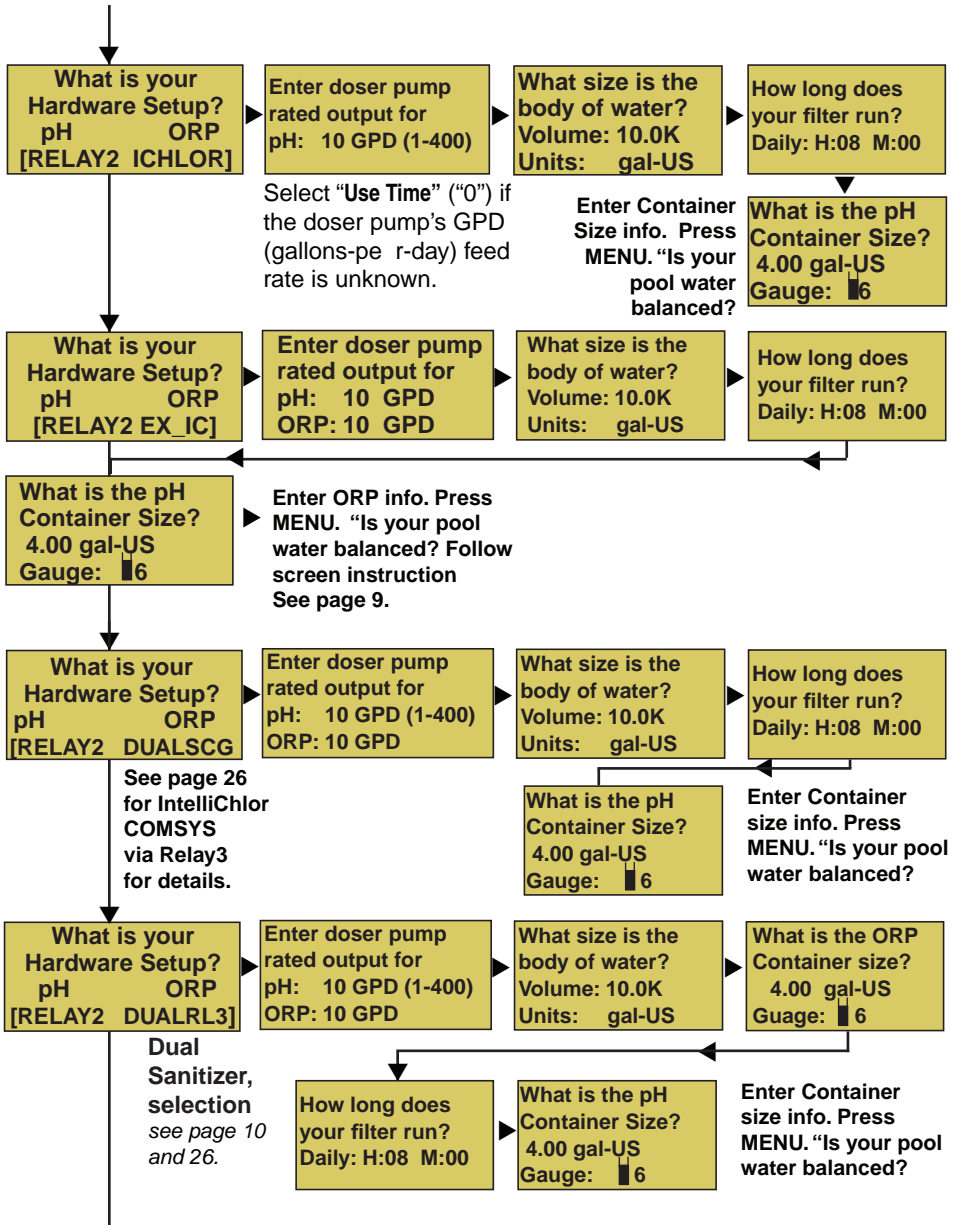

(\*) EX\_IC: IntelliChlor® Salt Chlorine Generator Output on RELAY #1.

EX\_IC also set ORP sensitivity = Off, whereas other cases are LOW. Selects Dose-by-Time, Dose Time set to 24:00:00 (all day) Removes container gauge. Turns off supply reminder (Default).

↓ Continue on next page.

## Auto Setup Sequence (Continued)

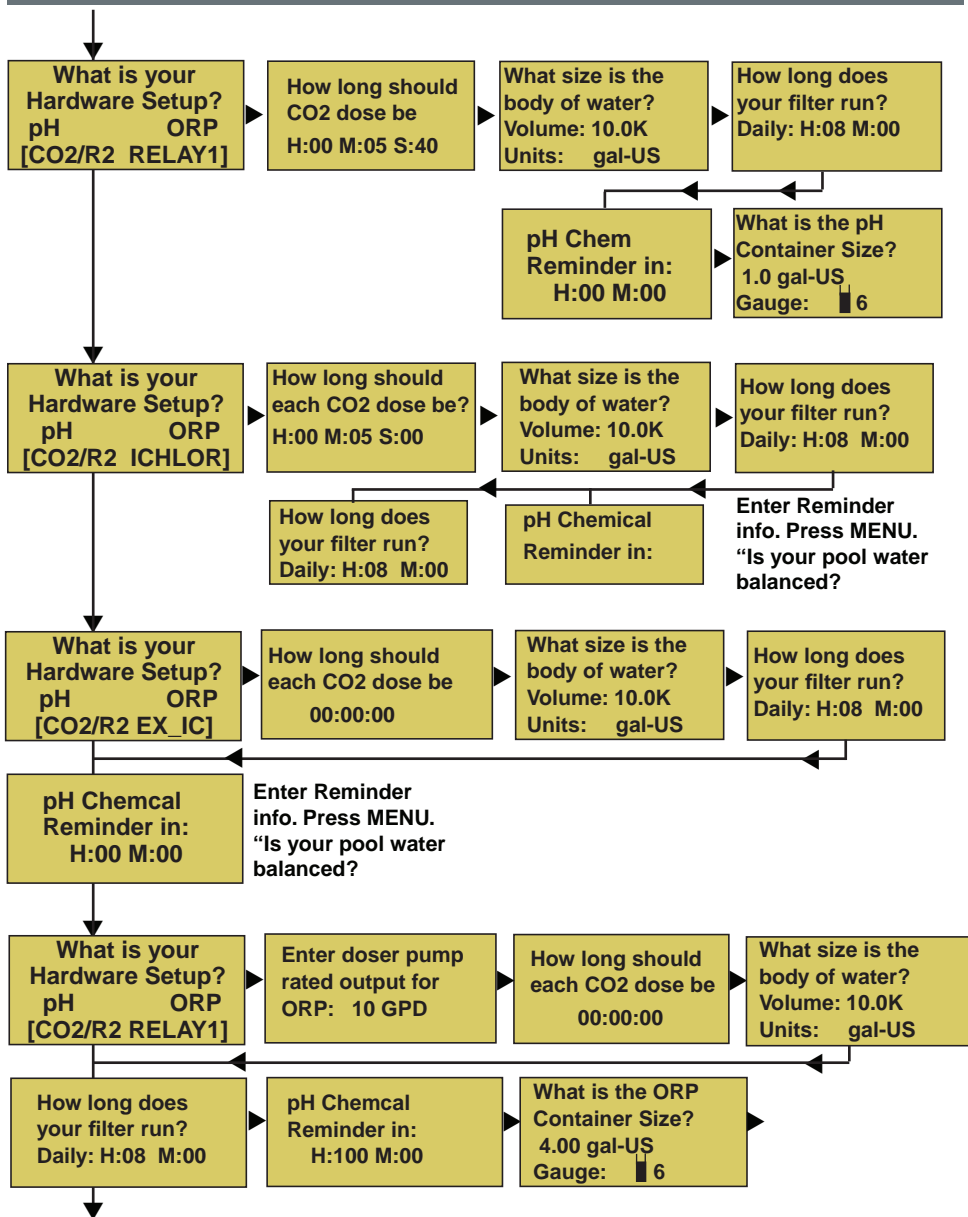

(\*\*) Note: If **Dual Sanitizer** is selected, the ORP menu adds item **Dual Bkup** which is the threshold below setpoint when the EX\_RELAY1 will start feeding. It is adjustable from 0 to 50mV (default=20mV)

## Auto Setup Sequence (Continued)

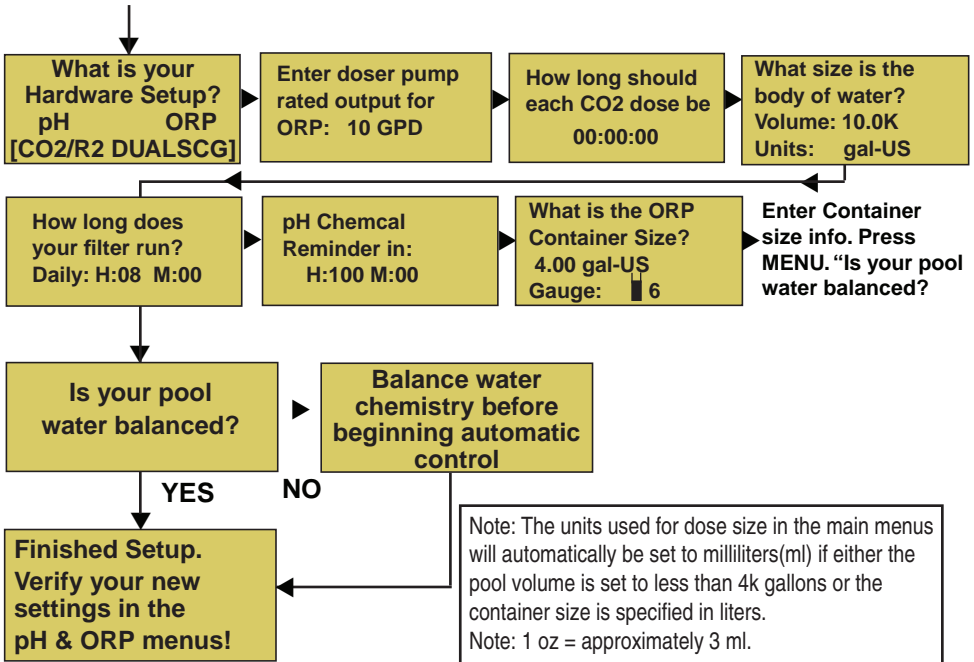

## IntelliChem Controller System Default Values

### pH

pH Set Point:	7.5
pH Alarm High:	7.8
pH Alarm Low:	6.8
pH Alarm Delays:	5 min. for both
Sensitivity:	Low (Off for CO2)

### ORP

ORP Set Point:	700
ORP Alarm High:	750
ORP Alarm Low:	650

### Miscellaneous Default Values

Display Mode:	Basic
Control Panel LED Brightness:	10%
Menu Timer:	M:02 S:30
Menu Backlight Timer:	M:00 M:20
Power-On Delay:	14 minutes
Flow Switch Delay:	1 minute



# MENUS

## MAIN SCREEN

### PH MENU

(page 13)

- **pH Dosage** (Screen 1/2) **Dosage (For liquid; Volume/Time):**  
(**For CO2; Time or to set point**): Mixing Time: H:24 M:59
- **pH Dose by Volume** (Screen 2/2) Dose: [0-9999], Limit: [0-64350],  
Units: [oz/ml], Clear [Power-On, Manual, 24-Hours]
- **pH Dose by Time** (2/2) Dose: [00:00:00], Limit: [00:00:00], Clear: [Power-On]
- **pH Dose to Setpoint** (2/2) Limit: [00:00:00], Clear: [24hr Flow]
- **pH Setpt:** 7.5 (use Left/Right button to adjust pH set point)
- **pH Tweak** - reading = 7.xx tweak: 0.0 (+/- 0.3)
- **pH Supply** (1/2) **Units:** gal-US/gal-UK/Liters/Time, **Chemical:** [Acid, pH-, Base, pH+] -  
(2/2) - **Capacity:** 0.000-200.00 gal-US/galUK/Liters - **Gauge:** Egg timer or tank gauge -  
(2/2) **Time:** Reminder in: H:100 M:00
- **Sensitivity:** - [Low/High/Off] - Full Dose at 0.5pH (Low - Liquid, CO2),  
(High 0.2pH from set point).
- **pH Alarms:** (1/2) High 7.8 - Delay 00:05:00 - (2/2) Low: 6.8 Delay 00:05:00

### ORP MENU

(page 16)

- **ORP Dosage** (1/2) **Dosage (For liquid; Volume/Time):**  
(**For Salt Chlorine Generator; Time or to set point**): Mixing Time: H:24 M:59
- **ORP Dose by Volume** (1/2) Dose: [0-9999], Limit: [0-64350], Units: [oz/ml], Clear [Man/PO/24]
- **ORP Dose by Time** (1/2) Dose: [00:00:00], Limit: [00:00:00], Clear: [Manual/PowerON/24 hrs.]
- **ORP Dose to Setpoint** (2/2) Limit: [00:00:00].
- **ORP Setpt:** 700 (use Left/Right button to adjust ORP set point)
- **Dual Bkup:** -20. For Dual Sanitizer selection. Adjustable from 0 to 50mV (default=20mV)
- **ORP Tweak** - reading = xxx tweak: 0.0 (+/- 50mV)
- **ORP Supply** (1/2) **Units:** gal-US/gal-UK/Liters/Time, **Chemical:** [Chlorine/Bromine] -  
(2/2) - **Capacity:** 0.000-200.00 gal-US/galUK/Liters - **Gauge:** Egg timer or tank gauge -
- **Gauge: Egg Timer or tank gauge** - (2/2) Time: Reminder in: H:100 M:00
- **Sensitivity:** - [Low/High/Off] - Full Dose at 50 mV ORP (Low - Liquid),  
(High 20 mV from set point, Off (IntelliChlor OFF)
- **ORP Alarms:** Screen 1/2: High 750 - Delay 01:00:00 - 2/2 Low: 650 Delay 02:00:00

### SAT INDEX

- See page 28 for details - pH: 7.5 - Temp: 00°F -

### AUTO SETUP

- See page 7 for details - CH: xxx - SLT: xxx - TA:xx = CYA: xx Recalc/Tab:

### CONFIGURATION

(page 19)

- **Pool Details:** Volume: 0.2K-230K (200-230,000 Liters max) Units:  
Gal US (gal-US/gal-UK/Liters), Daily Hrs/Mins
- **Display Mode:** Display Mode: Basic/Advanced, Brightness Front LEDs: (0-100%),  
Menu/BkLt Hrs/Mins. (24 hrs -30sec.)
- **Delays:** Power-On: 1-60 mins. (15min default) - FlowSwitch: 1-60 mins. (1 min default) -  
Doser/Probe: Seconds 0,15,30,60secs.
- **Set Password:** PW [1234] - Lock [Off/Menu/ALL]
- **Preferences: pH Lockout:** 7.8, **Preferences** (2/2): Saturation Index, Alarm: +/- 0.3,  
**Dose Priority:** [Simultaneous, pH Priority]
- **Diagnostics:** Software Rev, Meter Test (Auto Calibration),  
Probe Test (Open Probe Test) Timers, Chlorinator, Status Codes, Factory Reset, Self Test
- **Hardware: pH Control:** (1/2) Doser Type [Internal Pump, External/Relay,  
CO2 Ext/Relay, None] - pH Control. (2/2) Flow: xx GPD *See page 22 for details*
- **Hardware: ORP Control:** (1/2) Doser Type (None, IntelliChlor, External/Relay,  
Dual Sani: OFF/ICHLOR/RELAY3. (2/2) Ex\_Relay1 or Ex\_Relay2 (2/2:ICHLOR/all models)  
(2/2) External: Ex\_Relay1, Ex\_Relay2, Rate: Use Time, 1-400 GPD
- **Alarm Output:** None, Ex\_Relay1, Ex\_Relay2.

## Navigating IntelliChem® Controller Menus

The following examples show how to navigate the main menus and sub-menus. Press the **MENU button** to access the main menu. Press the **▶ Right arrow button** to select a menu item and select items in a sub-menu. Press **◀/▶** to select previous/next item on a page. To change a menu setting or value press the **▼/▲ Up/Down arrow button**. Press the MENU button to exit and return to the previous menu items. Note: Settings are automatically saved when changed.

Example: To change the pH dosage settings (pH Dosage screens 1/2 and 2/2):

Press **MENU ▼/▲ pH Menu ▶ pH Dosage ▶**

▶ pH Menu ▲  
ORP Menu  
Saturatn Index  
Auto Setup ▼

ORP Menu ▲  
Saturatn Index  
Auto Setup ▼

▶ pH Dosage  
pH Stpst: 7.5  
pH Tweak  
pH Supplies

pH Dosage 1/2  
Dose: by Volume  
Mixing Time:  
H:00 M:59

pH Dosage 2/2  
Dose Limit Units  
3 21 [oz]  
Clear [Power-On]

pH Dosage 1/2  
Dose: by Volume  
Mixing Time:  
H:09 M:59

▶ pH Menu ▲  
ORP Menu  
Auto Setup  
Configuration ▼

pH OK 7.46  
Mixing 00:07:03  
ORP OK 450  
Mixing 00:07:54

1. Press the **▼/▲ Up/Down arrow button** to scroll through the main menu items. For this example choose pH menu.
  2. Press the **▶ Right arrow button** to select the pH menu.
  3. Press **▶ arrow button** to select pH Dosage (page 1 of 2). Press **▼/▲** to toggle between pH Dosage page 1/2 and page 2/2.
  4. From pH Dosage page 1/2, press the **▶** to select Dose (feed method). To change the feed method press **▼/▲** to change the selection: "by Volume" or "by Time".
  5. Press the **▶** to select the next item. The cursor moves down to the "Mixing Time" hours setting (H:00).
  6. Press the **▼/▲** to adjust the Mixing Time hours between feeding acid. Press **▶** to select the minutes. Press **▼/▲** to adjust the minutes. After adjustment, the display shows the new setting. Note: Press either **◀/▶** button to scroll forward or backwards within this sub-menu.
  7. Select **1/2** page indicator. Press the **▼/▲** buttons to select the next pH Dosage screen (**2/2**).
  8. Use **◀/▶** buttons and **▼/▲** buttons to select and change the "Dose" (amount of liquid dispensed before waiting for a mix time), Limit (amount of liquid dispensed in one day, Units (apply to dose and limit) and clear dose limits setting.
  9. Press the **MENU** to return to the previous pH Dosage page 1/2 menu items.
  10. Press the **MENU** again to exit pH Dosage menu.
- Note: All settings are immediately save when changed.

## pH Menu Description

▶ pH Menu ▲  
 ORP Menu  
 Saturatn Index  
 Configuration

### by Volume

pH Dosage 2/2  
 Dose Limit Units  
 1200 64100 [mL]  
 Clear [Manual]

▶ pH Dosage ▲  
 pH Setpt: 7.2  
 pH Tweak  
 pH Supplies ▼

### by Time

pH Dosage 2/2  
 Dose 00:33:45  
 Limit 04:14:00  
 Clear [Power-On]

pH Dosage 1/2  
 Dose: by Time  
 Mixing Time:  
 H:00 M26

### by Setpoint

pH Dosage 2/2  
 Dose to Setpoint  
 Limit 00:08:00  
 Clear [24hr ]

**To access the pH Menu:** Press **MENU ▶ pH Menu ▶ pH Dosage** - The pH Dosage screen 1/2 displays the current dose method (by Volume, Time or to Setpoint).

## pH Dosage (for Internal and External Pumps)

### pH Dosage (page 1/2)

**Mixing Time:** Select the amount of time in hours and minutes that the IntelliChem® Controller will wait in between pH feeding. It should be set to allow sufficient mixing time for the chemicals to become distributed throughout the pool. The pH Mixing Time is set by Auto Setup.

**Dose (by Volume/Time):** Choose the feed method: “by Volume” and “by Time” are available choices for liquid dosers, as determined by the hardware setup. If CO2 is selected, then the available choices are “by Time” and “To Setpoint”. If pool volume is less than 4k gallons, these units automatically get set to milliliters (ml) for better resolution.

### pH Dosage (page 2/2)

**Dose (Volume):** Displays the current dose size (0-9999) in ounces [oz] or milliliters [ml]. Set the amount of ounces (or milliliters) that the IntelliChem controller will feed pH (acid) each time the IntelliChem controller calls for pH chemicals. The Dose (Volume) is set by Auto Setup wizard based on pool volume and filter run time.

**Dose (Time/Setpoint):** Displays the current pH dose (feed) time. If pool volume is less than 4k gallons, these units automatically get set to milliliters (ml) for better resolution. Sets the amount of time in hours, minutes and seconds that the IntelliChem controller will feed pH (acid) each time the IntelliChem controller calls for pH chemicals. The pH dose time is set by Auto Setup. The Dose (Time) is set by Auto Setup wizard based on pool volume and filter run time. Dose (to Setpoint) does not have a dose amount, only a time limit.

**Limit (Time/Volume):** Displays the current feed limit. Sets the maximum amount of time/volume in hours, minutes and seconds or volumetric units that will be allowed to feed pH chemicals. As a safety feature, the IntelliChem controller will only allow a certain amount of pH chemicals to feed into the system in a 24 hour period. Set the maximum amount of time in hours (0-24) that will be allowed to feed. The IntelliChem controller tracks each dose time, and adds them together. When the maximum dose time is reached or exceeded, the ORP feed system is prevented from feeding until the next 24 hour period begins, or when the feed timers are cleared manually. The default pH Limit is based on a safe limit of 2 ppm of the size of the pool, up to a 5 oz maximum. The Limit (Time/Volume) is set by Auto Setup wizard based on pool volume and filter run time.

*Continue on next page.*

## pH Menu Description (Continued)

### pH Dosage (page 2/2) *Continue*

**Clear:** Select **Power-On** to clear the pH dose limit time when IntelliChem® Controller is powered on. Select **Manual** to manually clear the pH dose limit timers and select **24 Hrs** to clear timers automatically each 24 hour period of continuous operation. To protect the pool water, IntelliChem controller will automatically shutdown pH and ORP feed control and display an alarm message if IntelliChem controller (or any other dispensing device) runs non-stop for more than the selected Limit time or volume. This prevents IntelliChem from non-stop feeding pH reducer, because of a sensor error or external problem with the pool. This allows you to evaluate the pool chemistry before continuing with pH feeding.

### pH Set Point

Displays the current pH set point value. Adjust the pH set point to meet pool and spa chemistry standards. The adjustable range is from 7.2 to 7.6 in increments of 0.1. The default pH set point value is 7.5.

To adjust the acid feed pH set point: Press **MENU pH Menu ►▼pHSetpt**  
**Press ◀/▶ to decrease or increase the current pH set point value.**

Note: When using CO<sub>2</sub>, parameters are the same as above.

### pH Tweak

The exact reading of each individual pH sensor can vary because of water makeup and variances in probe condition age, etc. The pH Tweak menu feature allows you to adjust the pH sensor reading to match the manual reading taken. The adjustable range is **+/- 0.3**. After adjusting the pH value, the main screen should now display the same value as the manual reading.

To adjust the pH sensor level:

Press **MENU ▼/▲ pH Menu ► pH Tweak**



The current value is displayed (reading = x.xx). Press **▼/▲** to adjust the pH sensor level (+/- 0.3). To remove the tweak, set the level back to 0 (zero).

### pH Supplies

#### pH Supply (page 1/2)

**Units:** Select gal-US, gal-UK, Liters or Time (hours/minutes)\*.

**Chemical:** Use Acid, (pH -) or Base (pH+).

<p><b>pH Supply</b> 1/2  <b>Unit: USGal</b>  <b>Chemical:</b>  <b>[Acid, pH-]</b></p>	<p><b>pH Supply</b> 2/2  <b>Capacity:</b>  <b>4.00 gal-US</b>  <b>Gauge:</b> 3 </p>	<p><b>pH Supply</b> 2/2  <b>Reminder in:</b>  <b>H:1000 M:00</b>  <b>Gauge:</b> 6 </p>
---	--	---

#### pH Supply (page 2/2)

**Capacity:** Select from 0 to 200 maximum gal-US, gal-UK, or Liters.

**\*Time (Reminder in: H:xxx M:xx)** If the supply Units were set to Time, the Capacity feature becomes a Reminder feature, as in an egg-timer. This can be used to trigger an alarm, based on cumulative feed times as to when to check the CO<sub>2</sub> cylinder. Set the reminder time in hours (0-8760) and minutes (00-59) on ORP Supply page 2/2. Note: Entering the hours and minutes time (H:00 M:00) will display the hour glass icon on the main screen.

**Level Gauge (liquid only):** Displays level gauge when using liquid chemical doser. Tank icon symbol is used for liquid chemical configurations that include valid supply and doser feed rate information.

## pH Menu (Continued)

### pH Sensitivity

The IntelliChem® Controller can adjust the feed times for pH depending on how close the current reading is to the set point. This helps to prevent overshooting and makes it easier for the IntelliChem controller to reach the exact set point. Note: **Low** = (default) Full dose at 0.5 pH above setpoint. **High** = Full dose at 0.2 pH above setpoint.

**Off** = Full dose at 0.005 pH above setpoint

For example: When set to LOW (full dose at 0.5 above setpoint), if pH setpoint is 7.2 and pH reading is 7.7 or above, a full dose amount is dispensed. As the pH comes closer to setpoint, say 7.45 (0.25 above setpoint - or- half the 0.5 pH value), the dispensed amount will be 1/2 of the specified dosage. And, at 0.05 (1/10th of 0.5 value) above setpoint (7.25), the dosage will be 10% of that specified in the dosage menu. In that case, if the dosage was specified to be 10 ounces, IntelliChem controller will dispense only 1 ounce at a time. This can be confusing because the display appears to not be dosing the full amount; therefore, in the Advanced display mode, the process timer shows “%Dosing 0.1 oz”, the “%” indicates the dosage is reduced due to this Sensitivity feature. In SPA Mode, the leading “s” in “sDosing 0.1 oz” indicates the dose is further reduced by 25%.

To set the pH Sensitivity level: Press MENU - pH Menu ▼/▲ pH Sensitivity ►

#### pH Sensitive - Monitoring in SPA Mode (Dosing)

pH	>OK	7.28	
Monitoring			
pH	OK	7.25	
sDosing		0.1 oz	

The Advanced display mode shows the current pH dosage. If both SPA Mode and %Sensitivity are active, the Advanced display screen will alternate between the two screens. “Dosing” message is preceded with an “s” to indicate automation is in SPA mode and the doses are cut to 25%.

pH	>OK	7.28	
Monitoring			
pH	OK	7.25	
%Dosing		0.1 oz	

“Dosing” is preceded with a “%” to indicate the dosage is being reduced through the Sensitivity feature.

Spa Mode is activated when the IntelliChem Controller detects that the control system has turned on the Spa. The SPA indicator should be illuminated on the automation control panel. Switching from a large body of water like a pool to a typically a smaller spa automatically reduces the dispensed dosage to 25% of a normal dose. The IntelliChem’s Advanced display precedes the Dosing message with a “s” to indicate it is in this mode. This feature is only available if the IntelliChem Controller is connected to a Pentair control system.

### pH Alarms

The IntelliChem controller automatically displays a screen message indicating the pH level has reached or exceeded the **HIGH (8.0) or LOW (6.8)** pH alarm level settings. The IntelliChem controller will automatically set a high and low alarm for the pH level. The Delay time is the amount of time between the detected alarm condition and when the IntelliChem controller displays the alarm message on the main screen. The Delay setting is adjusted in increments of 15 seconds.

To set the pH alarm “High” level and “Delay” time (page 1/2):

Press MENU pH Menu ► pH Alarms ► ▼/▲ pH Alarms ► ▼/▲ (page 1/2 is High Level Alarm, page 2/2 is Low Level Alarm)

Press ► to select the alarm, High level and Delay Time (00:50:00).

To set the pH alarm “Low” level and “Delay” time (page 2/2):

Press MENU ▼/▲ pH Menu ► pH Alarms ▼/▲ Low / Delay (2/2)

Press ▼/▲ to change pH alarms Low level and Delay Time (00:05:00).

## ORP Menu Description

### ORP Dosage (dispense chlorine or bromine)

pH Menu  
 ► ORP Menu  
 Saturatn Index  
 Configuration

#### by Volume

ORPDosage 2/2  
 Dose Limit Units  
 1200 64100 [mL]  
 Clear [Manual]

► ORP Dosage ▲  
 ORP Setpt: 700  
 ORP Tweak  
 ORP Supply ▼

#### by Time

ORPDosage 2/2  
 Dose 00:33:45  
 Limit 04:14:00  
 Clear [Power-On]

ORP Dosage 1/2  
 Dose: by Time  
 Mixing Time:  
 H:00 M26

#### by Setpoint

ORPDosage 2/2  
 Dose to Setpoint  
 Limit 00:08:00  
 Clear [24hr ]

**To access the ORP Menu:** Press **MENU ► ORP Menu ► ORP Dosage** - The ORP Dosage screen 1/2 displays the current dose method (by Time or to Setpoint).

### ORP Dosage (for Internal and External Pumps)

#### ORP Dosage (page 1/2)

**Mixing Time:** Select the amount of time in hours and minutes that IntelliChem will wait in between ORP dosing. It should be set to allow sufficient mixing time for the chemicals to become distributed throughout the pool. The ORP Mixing Time is set by Auto Setup.

**Dose (by Volume/Time):** Choose the feed method: “by Volume” and “by Time” are available choices for liquid dosers, as determined by the hardware setup. If IntelliChlor (SCG) is selected, then the available choices are “by Time” and “To Setpoint”.

#### ORP Dosage (page 2/2)

**Dose (Volume):** Displays the current dose size (0-9999) in ounces [oz] or milliliters [ml]. Set the amount of ounces (or milliliters) that IntelliChem will dose ORP (chlorine/bromine) each time IntelliChem calls for ORP chemicals. The Dose (Volume) is set by Auto Setup wizard based on pool volume and filter run time. If pool volume is less than 4k gallons, these units automatically get set to milliliters (ml) for better resolution.

**Dose (Time/Setpoint):** Displays the current ORP dose (feed) time. If pool volume is less than 4k gallons, these units automatically get set to milliliters (ml) for better resolution. Sets the amount of time in hours, minutes and seconds that IntelliChem will feed ORP (chlorine/bromine) each time IntelliChem calls for ORP chemicals. The ORP dose time is set by Auto Setup. The Dose (Time) is set by Auto Setup wizard based on pool volume and filter run time. Dose (to Setpoint) does not have a dose amount, only a time limit.

**Limit (Time/Volume):** Displays the current feed limit. Sets the maximum amount of time/volume in hours, minutes and seconds or volumetric units that will be allowed to feed ORP chemicals. As a safety feature, the IntelliChem will only allow a certain amount of ORP chemicals to feed into the system in a 24 hour period. Set the maximum amount of time in hours (0-24) that will be allowed to feed. IntelliChem tracks each dose time, and adds them together. When the maximum dose time is reached or exceeded, the ORP feed system is prevented from feeding until the next 24 hour period begins, or when the feed timers are cleared manually. The default ORP Limit is based on a safe limit of 2 ppm of the size of the pool, up to a 5 oz maximum. The Limit (Time/Volume) is set by Auto Setup wizard based on pool volume and filter run time.

**Clear:** Select **Power-On** to clear the ORP dose limit time when IntelliChem is powered on. Select **Manual** to manually clear the ORP dose limit timers and select **24 Hrs** to clear timers automatically each 24 hour period of continuous operation.

## ORP Menu Description (Continued)

### ORP Set Point

Displays the current ORP set point value. Adjust the ORP set point to meet pool and spa chemistry standards. The adjustable range is from 400 to 800 in increments of 10. The default ORP set point value is 700.

To adjust the ORP set point: Press **MENU ORP Menu ►▼ORP Setpt**  
**Press ◀/▶ to decrease or increase the current ORP set point value.**

Note: When using IntelliChlor SCG, parameters are the same as above.

### ORP Tweak

The exact reading of each individual ORP sensor can vary because of water makeup and variances in probe condition age, etc. The ORP Tweak menu feature allows you to adjust the ORP sensor reading to match the manual reading taken. The adjustable range is **+/- 50mV**. After adjusting the ORP value, the main screen should now display the same value as the manual reading.

To adjust the ORP sensor level:

Press **MENU ▼/▲ pH Menu ► ORP Tweak**

The current value is displayed (reading = x.xx). Press **▼/▲** to adjust the ORP sensor level (+/- 50 mV). To remove the tweak, set the level back to 0 (zero).

### ORP Supplies

#### ORP Supply (page 1/2)

**Units:** Select gal-US, gal-UK, Liters or Time (hours/minutes)\*.

**Chemical:** Use Chlorine or Bromine.

ORP Supply	1/2
Unit: USGal	
Chemical:	
[Chlorine]	

ORP Supply	2/2
Capacity:	
4.00 gal-US	
Gauge:	3 

ORP Supply	2/2
Reminder in:	
H:1000 M:00	
Gauge:	6 

#### ORP Supply (page 2/2)

**Capacity:** Select from 0 to 200 maximum gal-US, gal-UK, or Liters.

**\*Time (Reminder in: H:xxx M:xx)** If the supply Units were set to Time, the Capacity feature becomes a Reminder feature, as in an egg-timer. This can be used to trigger an alarm, based on cumulative feed times as to when to clean the SCG plates. Set the reminder time in hours (0-8760) and minutes (00-59) on ORP Supply page 2/2. Note: Entering the hours and minutes time (H:00 M:00) will display the hour glass icon on the main screen.

**Level Gauge (liquid only):** Displays level gauge hour when using liquid chemical doser. Tank icon symbol is used for liquid chemical configurations that include valid supply and doser feed rate information.



## ORP Menu Description (Continued)

### ORP Sensitivity

IntelliChem® Controller can adjust the feed times for ORP depending on how close the current reading is to the set point. This helps to prevent overshooting and makes it easier for IntelliChem controller to reach the exact set point. Note: **Low**= (default) Full dose at 50mV below setpoint. **High**= Full dose at 20mV below setpoint

**Off**= Full dose at 1mV below setpoint

For example: When set to LOW (full dose at 50mV below setpoint), if ORP setpoint is 700 and ORP reading is 650 or below, a full dose amount is dispensed. As the ORP comes closer to setpoint, say 675mV (25mV below setpoint - or- half the 50mV value), the dispensed amount will be 1/2 of the specified dosage. And, at 695 (1/10th of 50mV value) below setpoint (700), the dosage will be 10% of that specified in the dosage menu. In that case, if the dosage was specified to be 10 ounces, the IntelliChem controller will dispense only 1 ounce at a time. This can be confusing because the display appears to not be dosing the full amount; therefore, in the Advanced display mode, the process timer shows **“%Dosing 0.1 oz”**, the **“%”** indicates the dosage is reduced due to this Sensitivity feature. In SPA Mode, the leading **“s”** in **“sDosing 0.1 oz”** indicates the dose is further reduced by 25%.

To set the ORP Sensitivity level: Press MENU - ORP Menu ▼/▲ ORP Sensitivity ►

### ORP Sensitive - Monitoring in SPA Mode (Dosing)

ORP	>OK	7.28	
Monitoring	OK	652	
sDosing	0.1 oz		

The Advanced display mode shows the current ORP dosage. If both SPA Mode and %Sensitivity are active, the Advanced display screen will alternate between the two screens. “Dosing” message is preceded with an “s” to indicate automation is in SPA mode and the doses are cut to 25%.

ORP	>OK	7.28	
Monitoring	OK	652	
%Dosing	0.1 oz		

“Dosing” is preceded with a “%” to indicate the dosage is being reduced through the Sensitivity feature.

Spa Mode is activated when the IntelliChem Controller detects that the control system has turned on the Spa. The SPA indicator should be illuminated on the automation control panel. Switching from a large body of water like a pool to a typically a smaller spa automatically reduces the dispensed dosage to 25% of a normal dose. The IntelliChem’s Advanced display precedes the Dosing message with a “s” to indicate it is in this mode. This feature is only available if the IntelliChem Controller is connected to a Pentair control system.

### ORP Alarms

IntelliChem automatically displays a screen message indicating the ORP level has reached or exceeded the **HIGH (750 mV) or LOW (650 mV)** pH alarm level settings. IntelliChem will automatically set a high and low alarm for the ORP level. The Delay time is the amount of time between the detected alarm condition and when IntelliChem displays the alarm message on the main screen. The Delay setting is adjusted in increments of 15 seconds.

To set the ORP alarm “High” level and “Delay” time (page 1/2):

Press MENU ORP Menu ► ORP Alarms ► ▼/▲ ORP Alarms ► ▼/▲  
(page 1/2 is High Level Alarm, page 2/2 is Low Level Alarm)

Press ► to select the alarm, High level and Delay Time (00:50:00).

To set the ORP alarm “Low” level and “Delay” time (page 2/2):

Press MENU ▼/▲ ORP Menu ► ORP Alarms ▼/▲ Low / Delay (2/2)

Press ▼/▲ to change ORP alarms Low level and Delay Time (00:05:00).



## Configuration Menu

### Pool Details

---

From this menu, you can set your pool size, units to display and the daily run time which should match your daily pool pump filtration time.

**Volume:** Pool volume (size). Select range is 200 - 230,000 gal (gal-US, gal-UK and Liters).

**Units:** Select units to display in English (gal-US), (gal-UK) and Metric Liters.

**Daily:** This daily run time is used for calculating dose and mix times. It is set and used in the Auto Setup script and should be the amount of time the pool pump/filter runs each day.

To access the Pool Details menu:

Press **MENU ▼ Configuration ► Pool Details ►**

### Display Modes

---

**Mode:** Selects which display mode is displayed: **Basic or Advanced**, Basic mode displays the current pH and ORP levels with any alarms and fuel gauge if enabled. Advanced mode displays high resolution pH and ORP levels and process messages, timers (see page 7).

**LEDs:** Adjusts the brightness level (0-100%) of the front panel LEDs.

**Menu:** Adjusts the amount of time (minutes/seconds) the menu will be on each time the control panel is activated and also the time the entered password is valid.

**BkLt:** Adjusts the amount of time (hours/minutes) the controller screen backlight will be on each time the control panel is activated.

To access the display mode menu: Press **MENU ▼ Configuration ► ▼ Display ►**  
Press **▼/▲** to adjust display settings.

### Delays (minutes)

---

**Power-On:** Sets the delay time from power up to the first display screen reading. The adjustable time is from 1 to 60 minutes. The default power on time is 14 minutes

**Flow Switch:** Sets the delay time from when the Flow Switch is active to the first display screen reading. The adjustable time is from 1 to 60 minutes. The default flow switch delay time is one minute.

**Doser/Probe:** Sets the delay time from when the Doser turns on to when it takes the next probe measurement. Adjustable time is 0 to 60 seconds. Default is 15 seconds. Use longer times to prevent interaction of doser from affecting the measurement.

To access the delays menu: Press **MENU ▼ Configuration ► ▼ Delays ►**  
Press **▼/▲** to set the delay settings.

## Configuration Menu (Continued)

### Set Password

The IntelliChem® Controller menus, the pH button and ORP button on the control panel can be password protected. Once a password has been set, the IntelliChem controller will not allow access to the menu system and no changes to be made without entering the password. For more information see page 6.

**PW:** Enter a four digit password [0000]. Each digit can be assigned 0-9.

**Lock:** Select OFF, MENU (password protect the main menu) or ALL (password protect all control panel buttons.) Once the password is entered, access is granted for the duration specified by the Menu timeout setting in the Configuration/Display Mode menu. If the menus are locked, changes via the automation interface will also be locked out. To access the password menu:

Press **MENU ▼ Configuration ► ▼ Set Password ►**

Press **▼/▲** to select the digit and **◀/▶** move to next digit. Note: If you forget the password, first try the default password 1234, then call Customer Support for assistance.

### Preferences (1/2)

To access the delays menu: Press **MENU ▼/▲ Configuration ► ▼ Preferences ►**

Press **▼/▲** to adjust the following settings.

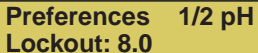

Preferences 1/2 pH  
Lockout: 8.0

**pH Lockout:** is the pH reading at which IntelliChem will no longer dose sanitizer (Chlorine/Bromine). Above pH of 8.0 it is generally understood that the ORP reading is suppressed and therefore will not be used to administer additional sanitizer. Just bringing the pH level down will raise the available chlorine and the effective ORP. At this trip point, an alarm message will be shown on the screen and ORP doses will cease.

Range is 7.7 to 8.2, default is 8.0.

## Configuration Menu (Continued)



### Preferences (2/2)



Preferences 2/2  
 Saturation Index  
 Alarm: Disabled  
 Delay: 00:30:00

#### Saturation Index

**Alarm: Disabled:** The Saturation Index (SI) level Alarm is set to Disabled as the default setting. If the Saturation Index (SI) level is in the “Corrosive” or “Scaling” range, this feature allows you to activate the alarm and enter a Saturation Index (SI) alarm threshold value between +/- 0.1 to +/- 0.9.

**Delay:** The Alarm Delay feature sets the delay time before the SI Alarm (see above) message is displayed. Enter the delay time from 00:15:00 to 24:00:00 (30 minutes default). Note: Once the SI has passed the threshold for the delay period, an alarm message is displayed showing the Saturation Index Alarm (along with other pH alarms) that includes the value and description.

pH >OK 7.44   
 -.72 Corrosive   
 ORP OK 730   
 Monitoring

pH >OK 7.44   
 +.32 Scaling   
 ORP OK 730   
 Monitoring

These alarm messages are also displayed on the IntelliTouch, EasyTouch and SunTouch control panel.

### Dose Priority

To access the delays menu: **Press MENU ▼/▲ Configuration ►▼ Dose Priority ►**  
 Press ▼/▲ to select option.

**Dose Priority:** pH Priority or Simultaneous.

Depending on how the IntelliChem chemical dosers are plumbed and how much water is circulating in the system where the chemicals are injected into the water stream, it may be preferred to only feed Chlorine when Acid is not feeding. This would be the pH Priority setting.

- Simultaneous allows both chemicals to feed at the same time - and can be used when both feed systems are not liquid chemicals or the injectors are separated by a safe distance in the water stream. DANGER: Combining liquid acid and chlorine can result in the formation of hazardous and explosive gas.
- pH Priority will always feed acid first, and only during the acid mix time or general monitoring period will the IntelliChem feed the liquid chlorine sanitizer. If while feeding chlorine, the pH rises above setpoint, the ORP dose will be stopped and allow acid to feed.

## Configuration Menu (Continued)

### Diagnostics

**Software Rev:** Displays the software revision.

**Meter Test:** Performs an internal self-test of the pH/ORP meter and sensing circuitry. Ensures both circuits are performing properly First tests the High circuit in the uncalibrated state, waits for a button press, then tests the Low circuit and waits for a button press. Once these two tests complete, it proceeds with the self-calibration. A Pass or Fail message is displayed. If this test fails, disconnect power and check for water or dirt on the circuit board. Use a can of dry compressed air to clean the board if necessary. If the test continues to fail, contact technical support.

**Probe Test:** This test takes approximately 30 seconds. Perform this test with the sensor cables and probes installed. Probes must be clean and in water. Possible results are :

#### Both Probes Good

**pH: Good            ORP:Bad**

**pH: Bad            ORP:Good**

**pH: Bad            ORP:Bad**

**Timers:** This displays the counters used for tracking the cumulating dose volume and/or time used in determining the Dose Limit. It shows:

“PCs” PH cumulative dose limit timer in Days HH:MM:SS

“Ocs” ORP cumulative dose limit timer in Days HH:MM:SS

“ml” Milliliters of cumulative dose for Ph and Orp (0-9999) stops at 9999 ml

“Run” the RUN TIME in Days, HH:MM:SS since powered up.

If you need to know how much you've dosed during a day, or how long its been running that day, “Timers” will have this information. The cumulative times/ml get reset when you clear the dose limits, The Run Time clears on power-up.

## Configuration Menu (Continued)

### Diagnostics (Continued)

**Chlorinator:** This screen displays the current IntelliChlor (SCG) status, salt (ppm) levels and error conditions. The hexadecimal status value is decoded and displayed in the brackets on the bottom line; multiple error conditions are shown by sequencing through the messages.

This display can be used to determine if the IntelliChlor SCG is connected and responding to the IntelliChem® Controller. If the IntelliChlor SCG is connected, this display may show “Please wait 2-7 minutes for ppm”. This indicates the IntelliChlor SCG is responding to initial contact but until water flow and sufficient salt level is reached, the IntelliChlor SCG will not respond with further information like salt ppm and status. Sometimes it is helpful to cycle power on the IntelliChlor SCG and wait 10 minutes for the green lights before it will respond with ppm and status information; it may not respond if the Salt or Cell lights are flashing red.

If the Configuration / Hardware / ORP Control / Doser Type is set to IntelliChlor, the IntelliChem will control the IntelliChlor as it would a doser, actively turning it on (100%) for chlorine demand, and off (0%) when the ORP reaches the desired set point.

For the Chlorinator to work when connected to an Automation controller such as the IntelliTouch®, EasyTouch®, or SunTouch® Control System, those units must be configured with the IntelliChlor SCG enabled. The displays is as follows:

-----  
Chlorinator Info:

Salt: 4500 ppm

Status Code=00H

[OK-NO ERRORS ] V

-----  
To get updated

ppm, cycle SCG

power and wait.

Press any button

-----  
Possible messages are:

No Flow

Low Salt

Very Low Salt

## Configuration Menu (Continued)

**Status Codes:** This displays a complex series of values that indicate the real-time status and alarm conditions.

Top line, Codes: HA= is the automation Home Address that IntelliChem has locked onto.

In the upper-right corner,

R0,1,2,4 which represents the UOC comm status.

R0 = standalone (no KA from Automation since power up)

R1 = Found KA packets within 30 seconds of power up

R2 = Found KA packets later, after 30 seconds, so was operating in standalone for a while

R4= Was in Automation mode (sending IntelliChlor commands through IntelliTouch) but has dropped the connection.

The two-digit number (0-99) directly below the R# is the number of seconds it's gone without a valid KA packet. It should generally be 00-04 seconds. More than that means that IntelliChem is missing the automation KA packets.

**Factory Reset:** Clear all calibrated values and run Auto Setup to initialize IntelliChem. For Factory Default Settings.

**Self Test Sequence:** Upon entering a self test sequence, all dosing will pause until the test is completed. Follow the on-screen prompts. "PASSED" indicates the test was successful. See Troubleshooting section for error conditions, on page 47.

## Hardware

Most common hardware configurations can be selected by using the Auto Setup Wizard. This menu allow more complex and custom settings. Use the Hardware menu to configure IntelliChem for the pH and ORP hardware controls and dose being used. Upon entering the hardware setup menu, all dosing will pause until the hardware setup is completed.

After pressing the Hardware button the following message is displayed.

Dosing will  
resume when you  
exit this menu  
Press any button

To access the hardware menu: **Press MENU ▼ Configuration ►▼ Hardware ►**

## pH Control (Screen 1/2 - 2/2)

**Doser Type 1/2:** Select the pH Control Dose Type:

- IntelliChem pH feed method being used (EXTERNAL/RELAY, CO2 Ext/RELAY (Carbon dioxide tanks), NONE).

**Doser Type 2/2:**

- **EXTERNAL/RELAY:** Ex\_Relay 2 or Ex\_Relay 1
- **EXTERNAL CO2:** Ex\_Relay 2 or or Ex\_Relay 1

**Flow (Rate) 2/2:**

- **Ex\_Relay 2:** RATE: 10 GPD (gallons per day). Note: Set to 0 to use time-based feed instead of volumetric
- **EXTERNAL CO2:** Use Time (0) or SCFH (1-400).

## Configuration Menu (Continued)

### ORP Control (Screen 1/2 - 2/2)

**Doser Type 1/2:** Select the ORP control hardware:

- IntelliChem ORP feed method being used (IntelliChlor, External/Relay, NONE).

**Dual Sanitizer:** OFF, ICHLOR or RELAY3 (for COMSYS SCG):

- If Dual Sanitizer is selected, ORP menu adds an item “Dual Bkup:-20” which is the threshold below setpoint when the EX\_RELAY1 will start feeding. It is adjustable from 0 to 50mV (default=20mV).

**Doser Type 2/2:**

- **EXTERNAL/RELAY:** Ex\_Relay 1, Ex\_Relay 2
- **INTELLICHLOR:** All Models (IC20, IC40, IC60). Dual Sanitizer set to OFF.

**Flow (Rate) 2/2:**

- **EXTERNAL:** Ex\_Relay 1, Ex\_Relay 2. RATE: 10 GPD (gallons per day).  
Note: Set to 0 to use time-based feed instead of volumetric (only on the Ext Relays).

Hardware settings must be chosen carefully. If both dosers are assigned to the same internal pump or external relay, the program will display an error message upon exiting the Hardware menu.

### Dual Sanitizer Feature

If Dual Sanitizer is selected, ORP menu adds Dual Bkup item which is the threshold below setpoint when the EX\_RELAY1 will start feeding. It is adjustable from 0 to 50mV (default=20mV).

### Auto Setup Mode

Dual Sanitizer Mode is selected in the Auto Setup (see page 7) by selecting ORP > DUAL along with pH set to either RELAY2 or CO2/R2. ORP Dosing is set up using EX\_RELAY1 to drive the Stenner pump at a 10 GPD rate.

### IntelliChlor SCG or COMSYS SCG via Relay3

In the Auto Setup wizard (see page 8), “DUALSCG” uses the IntelliChlor SCG as the primary sanitizer and the ORP Relay1 as the backup.

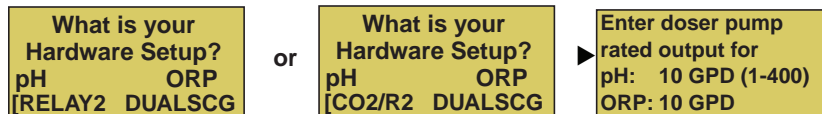

Continue to next page.

## Configuration Menu (Continued)

**DUALRL3 option:** Uses COMSYS SCG via add-on Relay3 as the primary sanitizer and the ORP Relay1 as backup.

What is your  
Hardware Setup?  
pH            ORP  
[RELAY2    DUALRL3]

What is your  
Hardware Setup?  
pH            ORP  
[CO2/R2    DUALRL3]

In the **Configuration/Hardware/ORP** menu, the choices for Dual Sanitizer are: OFF, ICHLOR, and RELAY3.

ORP Control    1/2  
Doser Type:  
[External/Relay]  
[DUALSani:OFF]

ORP Control    1/2  
Doser Type:  
[External/Relay]  
[DUALSani:ICHLOR]

ORP Control    1/2  
Doser Type:  
[External/Relay]  
[DUALSani:RELAY3]

**Note:** Using DUAL primary feeders (IntelliChlor or COMSYS SCG) operate as feed-to-setpoint. They will turn on immediately when the ORP drops below setpoint and off as soon as ORP stabilizes at setpoint.

The liquid doser (Ex\_Relay1) comes on at the Dual Bkup threshold below ORP setpoint, and follows all the normal liquid doser parameters (dosage, limit, mix times, etc) until the setpoint is achieved.

### During operation (Using IntelliChlor or COMMERCIAL SYSTEM (SCG))

Below ORP setpoint, if pH is below pH-Lockout level:

- SCG unit will be on
- The ORP LED will be on
- The IntelliChlor (SCG) output will turn on within one minute (typically within 15-30 seconds)
- pH Priority and Sensitivity do not affect the SCG operation
- SCG will run without a daily limit

Ext\_Relay1 will run when:

1. The ORP is below the Setpoint by more than Dual Bkup (0-50mV, default=20mV)
2. If IntelliChlor (SCG) cold-water bit 6 is set.

**External doser:** Relay 1 will run according to the prescribed settings

- Dosage, Limit, Sensitivity, pH Priority and pH lockout
- It will continue to dose & mix until setpoint or limit is achieved
- Throughout the subsequent Dosing & Mixing cycles

### Once Setpoint is reached

- SCG will turn off
- EX\_RELAY1 will turn off
- Returns to Monitoring mode and will not go into Mixing mode.



## Configuration Menu (Continued)

**Alarm Output** Select the following the IntelliChem® Controller alarm output information:

- **External alarm output:** Ex\_Relay1 or Ex\_Relay2.  
For an external alarm indicator, an unused relay may be selected to turn on when the red Alarm LED on the front panel is turned on. The alarm relay must be chosen carefully. If Ex\_Relay1 or Ex\_Relay2 is used for a doser, it must not be used for an alarm output. Upon exiting the Hardware menu, the program will check to be sure the same relay is not used more than once. If a relay is assigned to more than one function, an error message will be displayed.

error message:

```

-----
Alarm Relay
conflicts with
Ext Doser Relay
Changed to Ex_R1
----- or
Changed to Ex_R2
or
Changed to N/A
  
```

## Auto Setup Sequence

### Auto Setup

See page 7 for details.

## SAT Index Overview

### Saturation Index

The Saturation Index (SI), also called the Langelier Index, is a chemical equation or formula used to diagnose the water balance in the pool. The Saturation Index formula is **SI = pH + TF + CF + AF - 12.1 (or 12.2 for salt pools)**. To calculate the Saturation Index, you must first test the pool water for pH, temperature, calcium hardness, and total alkalinity. Refer to a chart for assigned values for your temperature, hardness, and alkalinity readings then add these to your pH value. Subtract 12.1 (or 12.2 for salt pools), which is the constant value assigned to Total Dissolved Solids and a resultant number will be produced. A result between +/-0.3 indicates balanced water. Test results not within these values require chemical adjustments to achieve balance. This formula is more or less reliable but not guaranteed. In some cases, individual readings for pH, calcium, and Total-Alkalinity might be beyond normal recommendations, however, combined within the formula can produce "balanced water." The SI is useful to pinpoint potential water balance problems.

To access the Sat Index menu:

Press MENU ▼/▲ Saturatn Index ►

Press ▼/▲ and ◀/▶ to adjust the Saturation Index values.

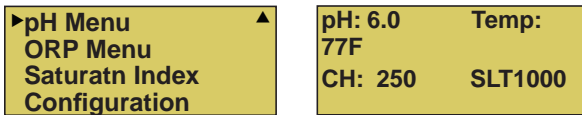

### Sat Index Menu

Note: The pH, Temp, and SLT are entered automatically as the numbers are available from the measurement and automation system. Each time this display is entered, if available, the current temperature is obtained from the IntelliTouch®, EasyTouch® Control System), SLT is obtained from the IntelliChlor® Salt Chlorine Generator (SCG). But these values can be changed on this screen for calculation purposes.

**pH:** Enter the current pH value.

**Temperature:** Enter the current temperature setting.

**CH:** Enter the current calcium hardness level.

**SLT:** Enter the current salt level or Total Dissolved Solids (TDS) level if no SCG is used.

**TA:** Enter the current total alkalinity value.

**CYA:** Enter the current cyanuric acid value.

**SI:** Displays the last calculated SI value (Corrosive/Scaling/Ideal). **Note: If there is no flow or Flow Delay is enabled, no SI value displayed.**

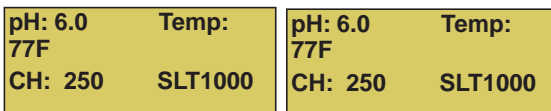

## Sat Index Overview (Continued)

### Recommended Pool Chemistry

<b>pH range:</b>	<b>7.2 to 7.6</b>
<b>ORP range:</b>	<b>650 to 750</b>
<b>Alkalinity:</b>	<b>80 to 120 ppm</b>
<b>Calcium Hardness:</b>	<b>200 - 500 ppm</b>

**pH:** Chlorine produced by the IntelliChlor® SCG is close to Neutral pH. However, other factors usually cause the pH of the pool water to rise. Therefore, the pH in a pool chlorinated by IntelliChlor SCG tends to stabilize at approximately 7.8. This is within APSP standards. If the pool pH rises above 7.8, have a pool professional test to see if other factors such as high Calcium Hardness or Total Alkalinity are the cause and then balance accordingly.

**Temperature:** The pool water temperature can affect the saturation index value. IntelliChem gets the temperature from the EasyTouch, IntelliTouch and SunTouch automation control system. The automation control system must have the POOL or SPA pump running to report the proper temperature to IntelliChem, otherwise IntelliChem will use its own menu's temperature value. To change the IntelliChem default temperature, select **Temp** and use the **Up/Down arrow** to adjust the temperature.

**pH Level Test:** Test the pH level of your pool water with a reliable test method. If necessary, adjust according to your pool professional's recommendations. APSP's recommended ideal range for pH is 7.2 to 7.6. Note: Never use dry acid (sodium bisulfate) to adjust pH in arid geographic areas with excessive evaporation and minimal dilution of pool water with fresh water. A buildup of by-products can damage the IntelliChlor SCG

### Calcium Hardness

Recommended range for calcium hardness is 200-500 ppm. Calcium Hardness levels should be tested weekly. Calcium hardness is the calcium carbonate scale deposited on pool surfaces. The test for Calcium Hardness is a measure of how "hard" or "soft" the water is testing. "Hard" water can have high levels of calcium and magnesium. If these levels are too high the water becomes saturated and will leave calcium carbonate scale deposits (a "white-ish," crystallized rough spot) on any surface inside the pool. If the levels are too low, the water becomes "soft" and will corrode surfaces inside the pool. Use TSP or Hydroquest 100 to lower Calcium Hardness levels that are too high or add water to the pool which has a lower calcium hardness content. Levels which are too low require the addition of calcium chloride.

**Total Dissolved Solids (TDS):** Adding salt to pool water will raise the TDS level. While this does not adversely affect the pool water chemistry or clarity, the pool water professional testing for TDS must be made aware salt has been added to the IntelliChlor system. The individual performing the TDS test may then subtract the salinity level to arrive at a TDS level that would be compatible to a TDS reading for a non-salt water pool.

**Note: If a salt chlorine generator is being used for your pool, the salt level is the TDS level of the pool.**

## Sat Index Overview (Continued)

### Total Alkalinity

APSP's recommended ideal range for total alkalinity is 80 to 120 ppm for "gunite" and concrete pools and 125-170 ppm for painted, vinyl, and fiberglass pools. Test levels weekly and adjust according to your pool professional's recommendations. Total Alkalinity can be described as a buffer that keeps pH in order. pH depends on the ability of the total alkalinity in the water to withstand the changes in pH. If the total alkalinity is too high, adding acid (similar to pH) lowers the level. Adding a base (e.g. sodium bicarbonate) when total alkalinity is low, raises the level. The level of total alkalinity in the water is a measurement of all carbonates, bicarbonates, hydroxides, and other alkaline substances found in the pool water.

### Cyanuric Acid

Cyanuric acid is needed in outdoor pools to help to stabilize and maintain proper levels of chlorine. 90% of unstabilized chlorine is destroyed by the UV radiation from the sun. Cyanuric acid stabilizes chlorine in water from UV degradation. When using the IntelliChlor SCG, the cyanuric acid level should be maintained between 30-50 ppm.

## Optimum Pool Water Chemistry Conditions for Salt Water Pools (using the IntelliChlor® Salt Chlorine Generator (SCG))

*In accordance with the Association of Pool and Spa Professionals (APSP) standards, it is recommended that the pool water chemistry conditions (see page 21) be maintained on an on going basis to help protect pool users, pool related equipment and surfaces in and around the pool.*

These values are important to maintaining the pool equipment in proper operating condition and preventing corrosion, liming or other problems. The IntelliChlor (SCG) is warranted to operate properly only if these conditions are met. For more information, refer to your local agency having jurisdiction, NSPI (National Spa and Pool Institute), the CDC (Centers for Disease Control), or the WHO (World Health Organization). Recommended pool water chemistry is given below:

**Free Chlorine:** 2.0 - 4.0 ppm. Above 4.0 ppm may cause corrosion of metal components

**Combined Chlorine (Chloramines):** None (super chlorinate to remove all chloramines)

**pH:** 7.2 - 7.8 (USE MURIATIC ACID to lower pH and Soda Ash to raise pH.)

**Cyanuric Acid:** 30 - 50 ppm

**Total Alkalinity:** 80 - 120 ppm

**Calcium Hardness:** 200 - 400 ppm

**TDS (includes salt):** 3000 minimum to 5700 to 6000 maximum ppm

**Salt:** 3000 - 4500 ppm (ideal 3400 ppm)

**Metals (Copper, Iron, Manganese):** None

**Nitrates:** None - **Phosphates:** Less than 125 ppb

## Using the Langelier Saturation Index (LSI) to Diagnose Water Balance

Use the **Langelier Saturation Index (LSI)** calculator to diagnose the water balance in your pool. Water with a LSI of 1.0 is one unit above a balanced condition. Reducing the factors by 1 unit will bring the water into equilibrium. To use the LSI calculator, refer to:

<http://www.pentairpool.com/support/calculators/langelier/index.htm>

## Sat Index Overview (Continued)

### Calculating the Saturation Index

The saturation index is a formula that relates pH, calcium and alkalinity in the pool water. A well balanced pool water will have a formula result range between -0.5 and 0.5. Outside this range, the pool water is out of balance, potentially damaging pool equipment or scaling the salt chlorine generator. The equation to calculate Si is:

$$SI = pH + CHF + AF + TF - TDSF$$

pH as  
tested

Calcium  
Hardness

TDS Factor  
(12.1 non-salt,  
12.2 salt pools)

Cyanuric acid in the form of cyanurate ions contribute to alkalinity. Thus, a correction must be made to total alkalinity. We subtract 1/3 of the cyanuric acid level from the reading obtained in the total alkalinity test.

### Total Alkalinity - 1/3 Cyanuric Acid = Corrected Alkalinity

This correction can be considerable in established pools with high cyanuric acid levels; for example, at 240 ppm cyanuric acid, the correction amounts to 80 ppm ( $240 \div 3 = 80$ ).

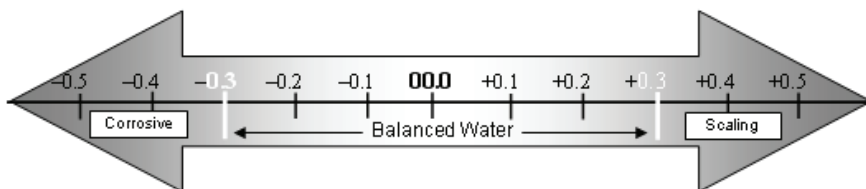

### Saturation Index Tables (as recommended by NSPF)

Temperature			Calcium Hardness		Total Carbonate Alkalinity	
°F	°C	TF	ppm (mg/L)	CHF	ppm (mg/L)	AF
32	0.0	0.0	25	1.0	25	1.4
37	2.8	0.1	50	1.3	50	1.7
46	7.8	0.2	75	1.5	75	1.9
53	11.7	0.3	100	1.6	100	2.0
60	15.6	0.4	125	1.7	125	2.1
66	18.9	0.5	150	1.8	150	2.2
76	24.4	0.6	200	1.9	200	2.3
84	28.9	0.7	250	2.0	250	2.4
94	34.4	0.8	300	2.1	300	2.5
105	40.6	0.9	400	2.2	400	2.6
			800	2.5	800	2.9

## INSTALLATION (COMMERCIAL INTELLICHEM® CONTROLLER AND FLOW CELL)

### Installing the Commercial IntelliChem® Controller

Before installing the IntelliChem controller, read the following instructions.

1. **IMPORTANT!** If the equipment pad is below the water level of the pool, please install a CHECK VALVE **after** the heater or use a Hartford Loop.
2. Identify new and existing equipment to be connected.
3. **Caution: The input water maximum pressure is 25 PSI.**
4. **Determine the supply voltage, and wire the transformer wires as needed (see page 34).**
5. Determine if the control to the equipment uses the same voltage as the supply voltage. All IntelliChem controlled equipment must be compatible.
6. Determine the water-tap points for the flow cell bypass inlet and outlet.
7. Install the Flow Cell away from direct sunlight and on a flat vertical surface.
8. Switch OFF the main system circuit breaker.
9. Connect the IntelliChem Controller to a power outlet that only has power when the MAIN FILTER PUMP has power (see page 40 for recommended wiring connections). This ensures that the IntelliChem controller will only dispense chemicals when the filter pump is ON.  
**Note: The IntelliChem Controller must be connected to a separate dedicated circuit GFCI.**
10. Install the bypass for the Flow Cell.
11. Connect the pH and ORP sensors.
12. Test the plumbing for leaks.
13. Switch on the IntelliChem controller for the first time as described on the following pages (page 33-43).

#### **⚠ DANGER**



#### **Risk of Electrical Shock or Electrocution!**

IntelliChem controller must be installed by a licensed or certified electrician or a qualified pool professional in accordance with the current National Electrical Code and all applicable local codes and ordinances. Improper installation will create an electrical hazard which could result in death or serious injury to pool users, installers or others due to electrical shock, and may also cause damage to property.

#### **⚠ WARNING**

Always disconnect the power to the IntelliChem controller enclosure at the circuit breaker before servicing the unit. Failure to do so could result in death or serious injury to serviceman, pool users or others due to electrical shock.

## Mounting Commercial IntelliChem® Controller

Mount the Commercial IntelliChem controller enclosure as follows:

1. Select a location for mounting the IntelliChem controller board.  
Recommended requirements are as follows:
2. Install the IntelliChem controller at least 10 feet from the pool or spa wall.
3. Supply power must be routed to the IntelliChem controller in accordance with the applicable national and current local (NEC) codes (see page i-iv).
4. The installation surface must be solid and vertical. Do not mount the IntelliChem controller enclosure in a horizontal position.
5. Maintain adequate clearance for opening the enclosure.
6. The environment should be free of chemical fumes and excessive heat. The maximum temperature it should not exceed is 110 °F (50 C).
7. Mount as far as possible from sources of electrical interference.
8. Mount the enclosure on a flat surface.
9. Hold the mounting board against the mounting surface and mark the location of the mounting holes located on the top corners of the board. Prepare holes as necessary and secure the board using the provided mounting screws.



Locate the chemical feed pumps and the chemical storage tanks in a safe and secure area. Never turn the chemical feed pumps on when both flow cell valves are closed. Increased pressure may cause the feed lines to blow off and spray full strength chemicals on anyone or anything near the equipment. Securely fasten all electrical, water, and chemical lines.

## Wiring the Commercial IntelliChem® Controller Transformer



### DANGER!

#### RISK OF ELECTRICAL SHOCK OR ELECTROCUTION

Always disconnect AC power to IntelliChem controller at the circuit breaker before servicing. Failure to do so could result in death or serious injury to installer, serviceman, pool users, or others due to electrical shock.

### HIGH VOLTAGE WIRING

The high voltage wiring compartment is located inside the IntelliChem controller enclosure. The IntelliChem controller must be connected to 120 VAC. Connect the IntelliChem Controller to a power outlet that only has power when the MAIN FILTER PUMP has power (see page 42 for recommended wiring connections). This ensures that the IntelliChem controller will only dispense chemicals when the filter pump is ON. There is no ground/bonding terminal required at this non-metallic enclosure. Follow manufacturers instructions when installing and testing of ground fault circuit breakers (GFCB) and interrupters (GFCI).

## Connecting Commercial IntelliChlor® SCG

Commercial IntelliChlor SCG units can be connected to the EX\_RELAY 3 dry contact relay. Relay contact ratings: 5 AMPS, 250 VAC / 30 VDC. See wiring diagram below and “Installation Plumbing Diagram” on page 39.

**⚠ DANGER** BE SURE TO DISCONNECT ALL SUPPLY CONNECTIONS BEFORE SERVICING THE INTELLICHEM® CONTROLLER.

**⚠ WARNING** Wiring external devices must be performed by a licensed electrician or a qualified pool professional in accordance with the current National Electrical Code (NEC), NFPA 70 or the Canadian Electrical Code (CEC), CSA C22.1. All applicable local installation codes and ordinances must also be adhered to. Improper installation will create an electrical hazard which could result in death or serious injury to pool users, installers or others due to electrical shock, and may also cause damage to property.

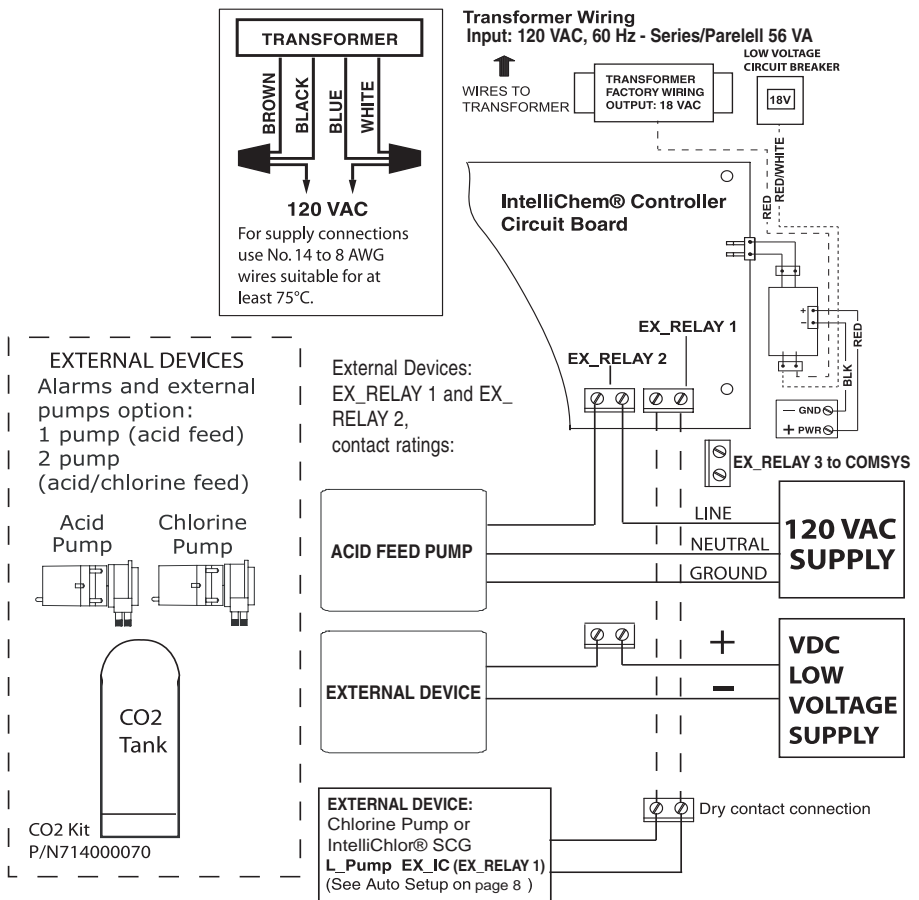

External Device Wiring Diagram



## Installing the Flow Cell and pH/ORP Sensors

### **WARNING**

pH and ORP sensors are shipped with a protective cap covering the electrode tip of the probes to protect the sensing element. **DO NOT MIX THESE CAPS** - Solutions will destroy the other type of probe. Sensors should be kept in the protective cap until ready for installation, if the sponge in the boot becomes dry, wet it with pool water. Before using the sensor remove the cap.

## Mounting the Flow Cell

Note: The 3/8" flexible tubing that is required to connect the flow cell to the rest of the system is included with IntelliChem controller kit.

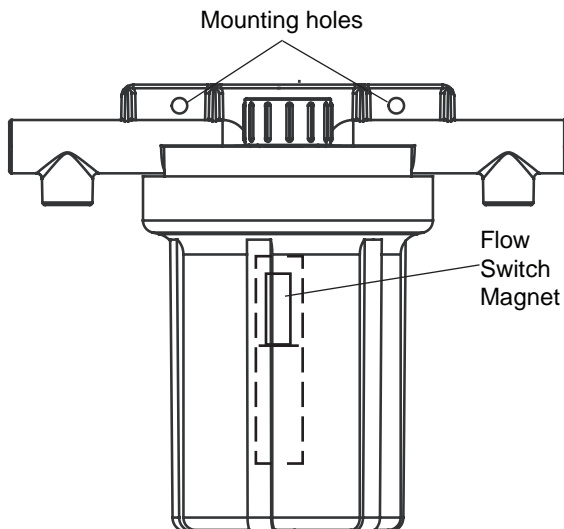

## Installing the pH and ORP Sensors (Read This First)

Install the pH and ORP sensors as follows: For IntelliChem® Controller Plumbing Installation Diagram, see page 39.

1. Sensors wires will connect to within 10 feet.
2. Water leaks will cause damage! Mount where water does not leak and damage other components.
3. Securely fasten all electrical, water and chemical lines.
4. Locate chemical feed pumps and chemical storage tanks in a safe and secure area.
5. Maximum operating pressure = 25 psi.
6. Extreme pressure variances may affect readings and can cause damage to the sensors.
7. Avoid installing the outlet before the main pump as the vacuum may damage the chemical sensors.

*Note: Do not over tighten fittings on flow cell top.*

## Installing the pH and ORP Sensors

To install the Flow Cell pH and ORP sensors:

1. Keep pH and ORP sensors wet at all times, install the sensors into the flow cell. **Hand-tighten only** and save caps for future use (DO NOT MIX THESE CAPS), fill flow cell with water. The sensors have O-Rings and don't require threaded sealing tape.
  - Do not rub hard on the glass element in the sensor or use sand paper or other polishing material to clean.
  - Handle electrode carefully.
  - Sensors contain external and internal glass elements.
  - Do not drop or otherwise subject the sensor to vibration, physical impact.

**⚠ WARNING** To avoid permanent damage of sensors or flow cell, do not use during freezing conditions.

- Leave excess wire outside the controller enclosure. If the cable is longer than needed, it should be coiled neatly and attached under the controller enclosure.
- DO NOT CUT THE SENSOR WIRES. Do not stuff excess wire inside the controller as this may cause excess strain on sensor and relay connections.

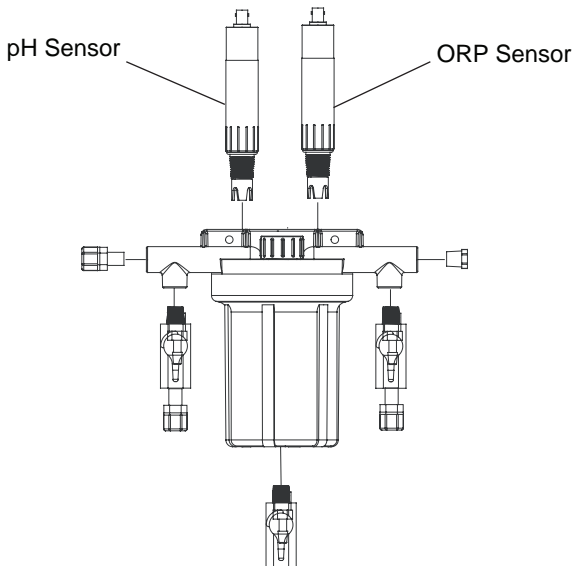

Flow Cell pH and ORP Sensor Connection Diagram

## Plumbing the Flow Cell

**⚠ WARNING** Be sure to have a licensed plumber perform all plumbing; this is important, as they will be familiar with all of the codes in the local area.

To connect the Flow Cell to the system plumbing: See page 39 for plumbing diagram.

1. At the equipment pad, switch off the filter pump and release the pressure from the system by opening the valve on top of the filter.

**⚠ WARNING** WARNING CHEMICAL BURN HAZARD: Make sure all pumps are switched off at the main circuit breakers at the house before drilling into any pipes. Securely fasten all electrical, water and chemical lines. Locate chemical feed pumps and chemical storage tanks in a safe and secure area.

2. Close all valves to prevent flooding.
3. Attach the IN and OUT tubes to the Flow Cell Inlet and Outlet (see Tubing Installation Diagram shown below).
4. Run the end of the IN tube to the chosen pressure line. Choose a location that provides enough space to drill and to tighten the clamp (must be after the filter, but before the heater). Be sure the tube is not pinched or kinked. Mark a spot on the pipe.
5. Locate where the water will be supplied from and returned for each flow cell. The most common location for the water inlet to the flow cell is **AFTER the main filter and BEFORE the heater**.
6. Drill a 3/8" hole for the flexible tubing fitting on the mark and immediately place the fitting into the pipe. Align pipe clamp with the fitting and tighten the pipe clamp.
7. Run the end of the OUT tube (with the pipe clamp) to the chosen return line. Choose a location that provides enough space to drill and to tighten the clamp (**must be after the heater**). Be sure the tube is not pinched or kinked. Mark a spot on the return line pipe.
8. Drill a 3/8" hole for the flexible tubing fitting on the mark and immediately place the fitting into the pipe. Align pipe clamp with the fitting and tighten the pipe clamp.
9. Open any closed system valves. Close the filter valve and turn on the circulation system. Check that the system is working properly.

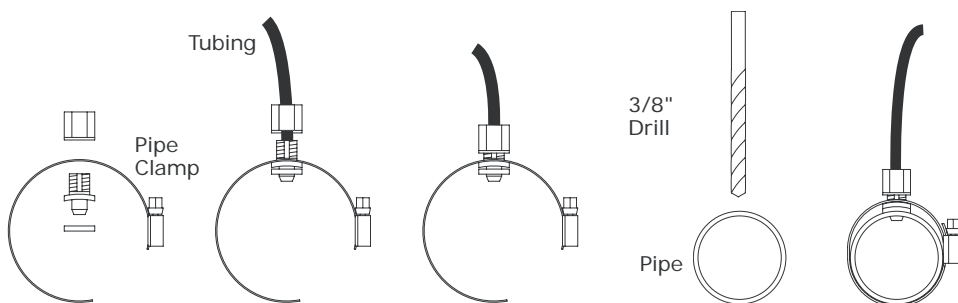

Tubing Installation Diagram

## Plumbing the Flow Cell (Continued)

**⚠ WARNING** Do not inject acid directly in to the flow cell. Injecting acid in this way will result in incorrect reading which may damage the existing pool equipment.

10. Locate the chemical injection points.
11. Prepare and install the chemical injector fittings.
12. Install the chemical storage containers.
13. Turn ON the main circulation pump.
14. Check for leaks and verify the flow sensor indicates flow.

### Flow Cell Inlet and Exit Lines

1. It is essential that the supply line be at a higher pressure than the discharge line so the water will flow through the cell at a steady rate in the right direction.
2. Inlet should be installed after filter and before heater. **Note: Plumb the INLET before the solar valve.**
3. Exit should be installed after heater and as far away from any equipment as possible.

**⚠ WARNING** Make sure all pumps are OFF before drilling into pipes. Never switch ON chemical feed pumps without the pool filter pump also running.

**⚠ CAUTION** The flow switch is a dry contact only (no current). Use with any other brand of flow switch voids WARRANTY and UL listing.

# Commercial IntelliChem® Controller Installation Plumbing Diagram

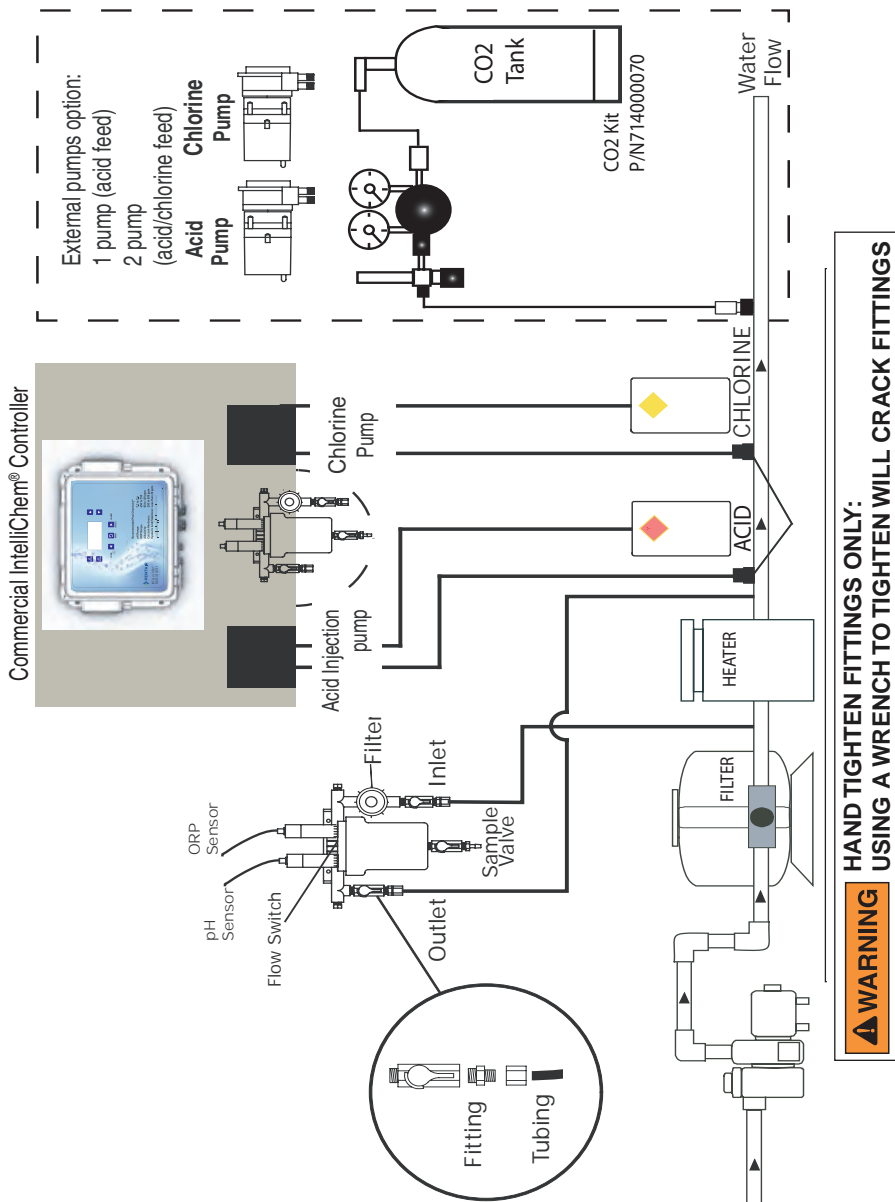

Figure 2: Commercial IntelliChem® Controller Plumbing

## CONNECTING TO SENSOR WIRES

**WARNING** The Flow Switch is a Dry Contact Only (No Current). This Flow Switch should only be used with the IntelliChem® Controller. Use of this Flow Switch with any other brand of controller will void the warranty and UL listing.

**NOTE: The Commercial IntelliChem Controller is factory pre-wired. Please skip Steps 1 and 2 below as they have all ready been completed at the factory.**

1. Route the Flow Cell switch wires into the IntelliChem controller enclosure through the strain relief and connect the wires to **J6 Sensor terminal connector** on the IntelliChem controller circuit board. **Connect the BLACK wire to the GND screw terminal and the RED wire to the FLOW screw terminal.**
2. Route the pH and ORP sensor wires into the IntelliChem controller enclosure through the strain relief and connect to J6 Sensor terminal connector on the IntelliChem controller circuit board. The sensor wires are labeled. PLUS AND MINUS POLARITY MUST BE OBSERVED.

**pH sensor wire:** Connect the GREEN to the pH - screw terminal and the CLEAR wire to the pH + screw terminal.

**ORP sensor wire:** Connect the GREEN to the ORP - screw terminal and the CLEAR wire to the ORP + screw terminal.

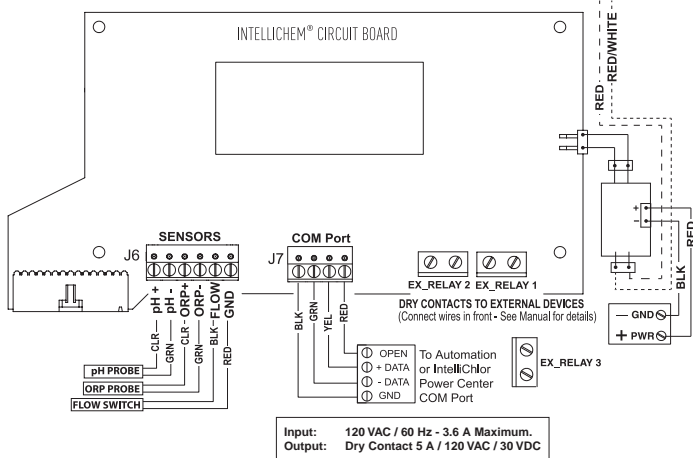

Figure 2: Commercial IntelliChem Controller J6/J7 Circuit Board

3. Turn the main pump on and open the valves to test for leaks and the free movement of magnet. Magnet must be all the way up in order to close the flow switch. 1/4 GPM will push the magnet all the way up.

**WARNING** Make sure that all pumps are off before drilling into any pipe.

**WARNING** Never turn chemical feed pumps on when either flow cell valve is closed.

## CONNECTING TO AN AUTOMATION CONTROL SYSTEM

### Wiring Commercial IntelliChem® Controller AC Power to Filter Pump Relay

**Commercial IntelliChem AC Power Wiring Instructions:** When using Commercial IntelliChem as a stand alone device (with a time clock) or with an Commercial IntelliChlor salt chlorine generator, Commercial IntelliChem **MUST BE CONNECTED TO A POWER OUTLET THAT ONLY HAS POWER WHEN THE MAIN FILTER PUMP HAS POWER.** This ensures that Commercial IntelliChem Controller will only dispense chemicals when the filter pump is ON. For IntelliTouch®, EasyTouch® or SunTouch® Control System using an IntelliFlo® pump (or 2-speed pump) and an IntelliChlor® (SCG), the Commercial IntelliChlor Controller AC power center wires must also be connected to the **LOAD SIDE OF THE MAIN FILTER PUMP RELAY** located in the load/power center (see page 42 for diagram). This ensures that Commercial IntelliChem controller and IntelliChlor SCG only produce chlorine when the main filter pump is on.

The following wiring diagram (see next page) shows the Commercial IntelliChem Controller AC power wiring and COM port connections to the EasyTouch, IntelliTouch and SunTouch Control System.

**IntelliChem® Controller AC Power and COM port (RS-485) Wiring Diagram**

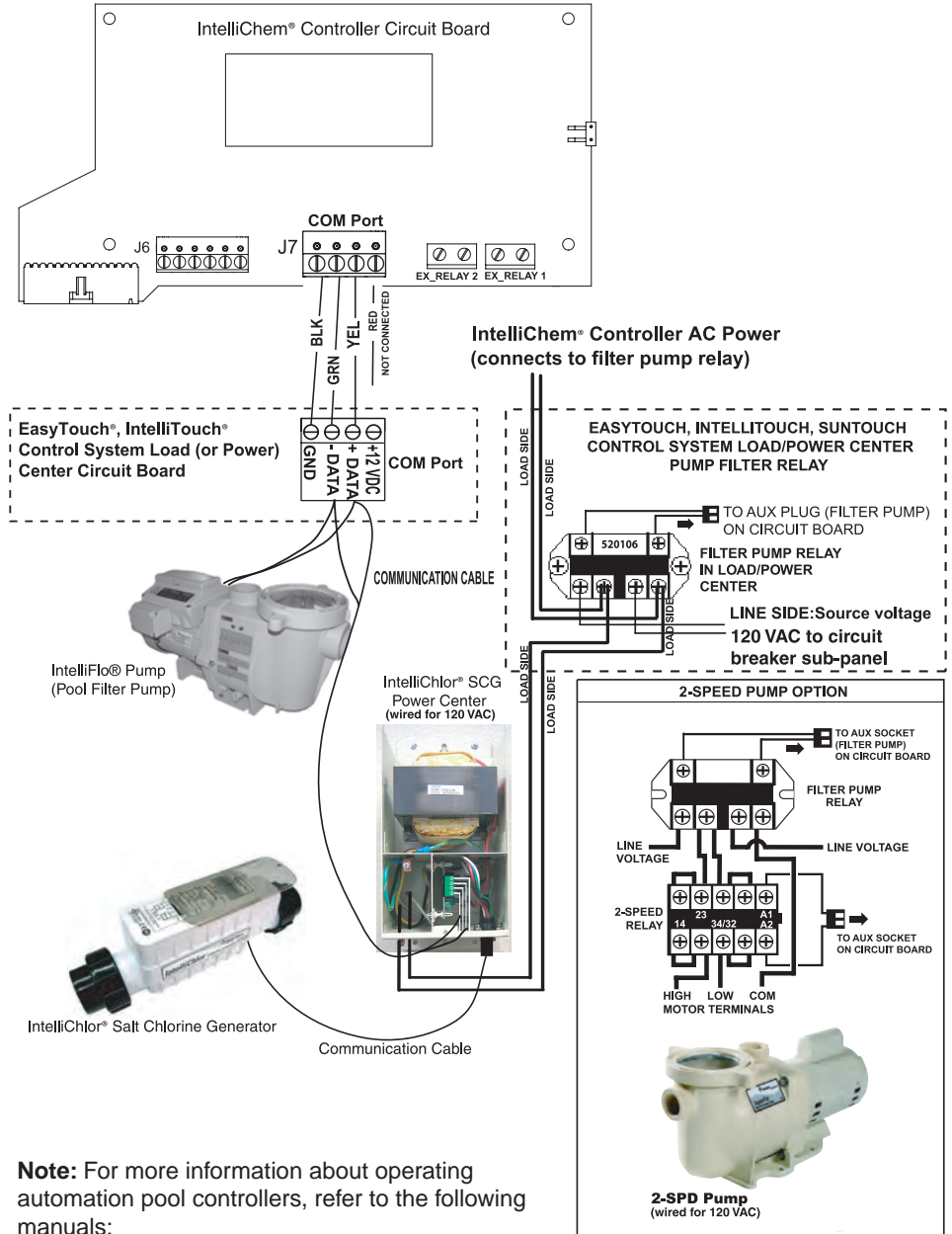

**Note:** For more information about operating automation pool controllers, refer to the following manuals:

- IntelliTouch® Control System User's Guide (P/N 521075)
- EasyTouch® Control System User's Guide (P/N 521044)



## Wiring the IntelliChem Controller AC Power to Automation Filter Pump Relay

Please read the following information before starting.

**Commercial IntelliChem AC Power Wiring Instructions:** When using Commercial IntelliChem as a stand alone device (with a time clock) or with an Commercial IntelliChlor salt chlorine generator, Commercial IntelliChem **MUST BE CONNECTED TO TO A POWER OUTLET THAT ONLY HAS POWER WHEN THE MAIN FILTER PUMP HAS POWER.** This ensures that Commercial IntelliChem Controller will only dispense chemicals when the filter pump is ON. For IntelliTouch®, EasyTouch® or SunTouch® Control System using an IntelliFlo® pump (or 2-speed pump) and an IntelliChlor® (SCG), the Commercial IntelliChlor Controller AC power center wires must also be connected to the **LOAD SIDE OF THE MAIN FILTER PUMP RELAY** located in the load/power center (see page 42 for diagram). This ensures that Commercial IntelliChem controller and IntelliChlor SCG only produce chlorine when the main filter pump is on.

To connect IntelliChem controller AC power wires to EasyTouch, IntelliTouch and SunTouch Control System filter pump relay (see diagram on previous

**⚠ DANGER**



**D A N G E R !**

### RISK OF ELECTRICAL SHOCK OR ELECTROCUTION

Always disconnect AC power to EasyTouch, IntelliTouch and SunTouch control system load/power center at the circuit breaker before servicing, or removing the HIGH VOLTAGE FRONT PANEL. Failure to do so could result in death or serious injury to installer, service person, pool users, or others due to electrical shock.

1. **IntelliChem Controller AC power:** Run the IntelliChem controller AC power wires to the EasyTouch, IntelliTouch or SunTouch control system enclosure.
2. **EasyTouch or IntelliTouch Control System Load Center:** Unlatch the enclosure door spring latch, and open the door.
3. **Discharge Electrostatic energy before removing the cover by first touching the metal part of the enclosure.**
4. Loosen the two (2) retaining screws from the HIGH VOLTAGE FRONT PANEL. Remove the panel from the enclosure.
5. Connect the IntelliChem controller AC power cord wires to the LOAD/ PUMP SIDE of the main filter pump relay (see wiring diagram on page 42).
6. When the connection is completed: **EasyTouch and IntelliTouch Control System:** Close the control panel and secure it with the two (2) retaining screws. **SunTouch Control System:** Close the front control panel and secure with the retaining screw.
7. Close the load center front door. Fasten the spring latch.

## Connecting IntelliChem® Controller RS-485 Communication Cable to the Control System Circuit Board

To connect the IntelliChem controller COM Port Cable to EasyTouch®, IntelliTouch® and SunTouch® Control System COM port (see page 39):

1. **IntelliChem controller RS-485 cable:** Strip back the cable conductors  $\frac{1}{4}$  in. Insert the wires into the connector screw terminals. Make sure to match the color coding of the wires; YELLOW = +DATA, GREEN = -DATA and BLACK = GND. (Red wire is not connected). Secure the wires with the screws.
2. Run an RS-485 cable from the IntelliChem controller enclosure to the EasyTouch, IntelliTouch or SunTouch control systems enclosure.
3. Unlatch the load center/power center enclosure door spring latch, and open the door.
4. **WARNING! Switch AC power OFF to load/power center before installation (see note on page 39) EasyTouch or IntelliTouch control system load center:** Loosen the two (2) retaining screws from the control panel. **(a)** Lower down the control panel on its hinges to access the motherboard located behind the control panel. **(b)** Route the IntelliChem controller RS-485 cable up through the low voltage raceway in the load center to the motherboard.  
**SunTouch Control System Power Center:** Route the conductor cable up through the lower grommet opening into the enclosure.
5. Strip back the IntelliChem controller cable conductors  $\frac{1}{4}$  in. Insert the wires into the COM port connector screw terminals on the circuit board: **(EasyTouch J20, IntelliTouch J7/8, SunTouch J11)**. Make sure to match the color coding of the wires; YELLOW = +DATA, GREEN = -DATA and BLACK = GND. (Red wire is not connected). Secure the wires with the screws.
6. When the connection is completed: **EasyTouch and IntelliTouch Control System:** Close the control panel and secure it with the two (2) retaining screws. **SunTouch Control System:** Close the front control panel and secure with the retaining screw.

## Setting Up EasyTouch, IntelliTouch & SunTouch Control System

### IntelliTouch Control System

The following describes how to setup the IntelliChem controller from the IntelliTouch control system control panel. From the IntelliTouch control system control panel you can adjust the pH and ORP set point values, view the IntelliChem controller status and monitor your pool water condition using the Saturation Index. To access the IntelliChem controller the screens, from the IntelliTouch control system indoor control panel or the wireless MobileTouch® Controller control panel:



**PH/ORP Values:** The pH and ORP values are displayed next to the set point settings.

**pH Set:** Displays the current pH set point value. The adjustable range is from 7.2 to 7.6 in increments of 0.1. The default pH set point value is 7.5. To adjust the pH set point, press the button next to pH Set.

**ORP Set:** Displays the current ORP set point value. The adjustable range is from 650 to 800 in increments of 10. The default ORP set point value is 700. The ORP set point is the value that IntelliChem will try to achieve based on the active sanitizer. To adjust the ORP set point, press the button next to ORP Set.

**STATUS:** Displays the current communication link between IntelliTouch and IntelliChem via the RS-485 cable. **IChem Comm Error:** Check the RS-485 communication cable is connected to the COM port on the IntelliTouch Personality circuit board.

**USING SCG:** "USING SCG" displays if the IntelliChlor salt chlorine generator is enabled. The SCG is enabled and disabled from the MENU > SETUP > EQUIPMENT > CHLORINATOR screen. **Note: IntelliChem must also be set up to use the IntelliChlor SCG either with the AUTO SETUP Setup Wizard (page 6) or the Configuration/Hardware/ORP Control/Doser Type (page 24).**

**DISABLE/ENABLE INTELLICHEM:** To disable IntelliChem, press the button under DISABLE ICHEM. To enable IntelliChem, press the button next to INTELLICHEM. On the next screen press button next to NO and select **YES**. Press SAVE to save the setting and return to the Equipment screen.

**Saturation Index/Menu:** To access the Saturation Index screen, press the button next to SATURATION INDEX/MENU. The current Saturation Index value, water condition, water temperature and salt level are displayed. Press the button next the following selections to adjust the levels/values: **Calcium Hardness:** Recommended range is 200-400 ppm. Levels should be tested weekly. **Cyanuric Acid:** Stabilizes chlorine in water from UV degradation. When using the IntelliChlor SCG, cyanuric acid level should be maintained between 30-50 ppm.

**Total Alkalinity:** APSP's recommended ideal range for is 80 to 120 ppm for "gunite" and concrete pools and 125-170 ppm for painted, vinyl, and fiberglass pools. Test levels weekly and adjust according to your pool professional's recommendations.

**Saturation Index:** The saturation Index displays IDEAL (Optimum levels), CORROSIVE or SCALING. The following are recommended pool chemistry Saturation Index levels: **pH range: 7.2 to 7.6** **ORP range: 650 to 800.** **Alkanlinity: 80 to 120 ppm.** **Calcium Hardness: 200 - 500 ppm.** **Cyanuric Acid/Stabilizer: 30-50 ppm.**

**Note:** See page 31 for information about the online **Langelier Saturation Index (LSI) Calculator** to diagnose the water balance in your pool.

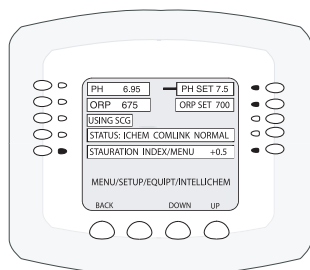
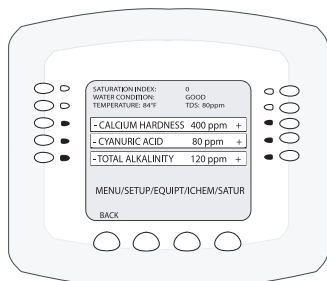
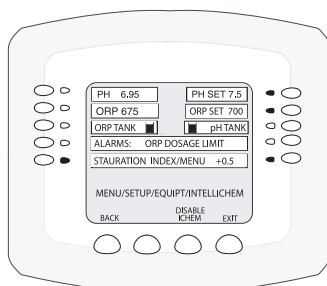

## Setting Up IntelliChem® Controller with EasyTouch Control System

### EasyTouch® Control System

The following describes how to setup the IntelliChem® Controller from the EasyTouch control system control panel. From the control panel you can adjust the pH and ORP set point values, view the IntelliChem controller status and monitor your pool water condition using the Saturation Index. To access the IntelliChem screens, from the EasyTouch Indoor Control Panel or the EasyTouch Wireless Control Panel: **Press MENU > SETTINGS > INTELLICHEM**

Clock ▲  
IntelliFlo  
IntelliChlor  
▶ IntelliChem ▼

IntelliChem  
▶ PH/ORP Values  
Status  
Sat Index

pH	VAL	7.0
pH	SET:	7.5
ORP	VAL:	650
ORP	SET:	750

IntelliChem  
PH/ORP Values  
▶ Status  
Sat Index

pH	Lvl:	▯
ORP	Lvl:	SCG
IntelliChem: ON		
ORP Dosage Limit		

IntelliChem  
PH/ORP Values  
Status  
▶ Sat Index

pH: 7.5	TMP: 91
CH: 250	SLT: 4250
TA: 100	CYA: 30

**PH/ORP Values:** Press the **Right button** to access the pH and ORP set point values screen. The pH and ORP sensor reading VALues are shown only if adequate flow is sensed by the flow switch and the delay has been satisfied, otherwise displays NA (not available) Use the **Up/Down** button to adjust the pH set point value. Press the **Right button** again to set the ORP set point value. Press **MENU** to save and return to the previous screen.

**pH Set Point:** Displays the current pH set point value. The adjustable range is from 7.2 to 7.6 in increments of 0.1. The default pH set point value is 7.5.

**ORP Set Point:** Displays the current ORP set point value. Use the **Up/Down button** to adjust the ORP set point value. The adjustable range is from 650 to 800 in increments of 10. The default ORP set point value is 700. The ORP set point is the value that IntelliChem will try to achieve.

**STATUS:** Displays the current communication link between EasyTouch and IntelliChem via the RS-485 cable. **IChem Comm Error:** Check the RS-485 cable is connected to the COM port on the EasyTouch control system circuit board. If "IntelliChem: --Disabled--" is displayed enabled IntelliChem from the automation system (see "Using SCG" on page 45). Other alarm messages are shown on page 49.

**Level Gauge indicator:** Press the **Up/Down button** to "fill" the gauge icon so that it visually represents the same amount of acid available in the container. Press Up/Down button six (6) times to fill the gauge (three times to half fill the gauge). Six horizontal bars represent chlorine (or bromine) supply is full. One bar indicates the supply is nearly empty. Press MENU twice to exit and update the values.

**Note:** IntelliChem controller must also be set up to use the IntelliChlor® SCG either with the AUTO SETUP Wizard (page 7) or the Configuration/Hardware/ORP Control/Doser Type (page 24).

**Sat Index:** To access the Sat Index settings, press the **Up/Down button** then press the **Right button**. Use the **Up/Down button** to adjust the levels/values for: **CH (calcium hardness)**, **SLT (Salt Content in water or Total Dissolved Solids if no salt is present)**, **TA (total alkalinity)**, **CYA (cyanuric acid)** and **TMP (current temperature)**. **Note: See table below for ideal Saturation Index levels.** **SI:** The saturation Index is displayed. **IDEAL:** Optimum levels. **CORROSIVE** or **SCALING:** Press the **Menu** button twice to exit and update the values. Return to this menu for updated SI calculations. screen. **Note: See page 31 for information the online Langelier Saturation Index (LSI) Calculator to diagnose the water balance in your pool.**

## Setting up IntelliChem® Controller with SunTouch Control System

### SunTouch Automation Control System

The following describes how to view the current IntelliChem pH and ORP levels from the SunTouch control panel. To access the IntelliChem screens **Press MENU > DIAGNOSTICS > INTELLICHEM**

**IntelliChem**

**pH: 7.65 ORP:832**

Displays the current pH and ORP levels. The IntelliChem controller is connected to the SunTouch control system via the RS-485 cable. The RS-485 communication cable is connected to the COM port on the SunTouch® Control System circuit board.

## TROUBLESHOOTING

### General Troubleshooting Guide (also see Help Guide on page 48)

1. Run Meter Self-Test (see Configuration menu)
2. Run Probe-Open Test (see Configuration menu)
3. Clear pH and ORP Tweaks (see Configuration menu)
4. Clean Sensors (see Maintenance section)
5. Check chemicals and feed system
6. Take sample of pool water for analysis of CYA, alkalinity, check saturation index, Balance water
7. Replace Sensors
8. Repeat above steps

### General Guidelines - pH or ORP not able to reach setpoint

This may be a common issue that can easily be resolved by increasing the amount of chemical dispensed each day. If the pH Sensitivity is set to "Low" (the default), IntelliChem will only administer the full dose at 0.5 from setpoint. If it seems to be stuck 0.3 from setpoint, you're only getting 3/5 of the programmed dose. Change the Sensitivity to "High" and you'll get the full dose at 0.2 pH or greater from setpoint. Or, turn pH Sensitivity OFF - only turn it on if you're overshooting the setpoint.

Increasing the dose would essentially do the same thing. Increase the dosage as well as the dose-limit and reduce the mix time so you still get all 8 doses in the filter run time.

### Diagnostics Self Test and Error codes

The overall functionality of the IntelliChem can be verified by running the self test. Access this feature in the Configuration/Diagnostic menu. The test verify the LCD display, front panel LED indicators, push buttons, flow switch input, doser motors, relays, the RS-485 communication, and the meter.

**Warning! This test will turn on the doser, so be sure that the tubing is installed in a safe manner so that the chemicals will be safely contained.**

#### Error Codes (Self Test Status: Fail)

01H : LCD

02H : Backlight

04H : LEDs

08H : Buttons

10H : Flow Switch

20H : Outputs

40H : Loopback 485

80H : Meter

## Help Guide

Sequence	Access	Action
Meter Test	Menu/Configuration/Diagnostics Run Meter Test	Use this test to verify that the pH and ORP sensing circuitry and meters are operating properly. The test first shows diagnostic uncalibrated values for test circuit H, then test circuit L. It then runs the Auto Calibration and shows two values for each. If the bottom line shows *** PASS *** the meter and sensing circuitry is good. If the test fails, these values can be used at the factory to determine which part of the circuit is faulty.
Probe Test	Menu/Configuration/Diagnostics Run Meter Test	This is a 30 second test that evaluates the inputs to the pH and ORP meters. The results are used to determine if the probes are functioning. It will accurately detect if a probe is disconnected or has broken or shorted wires. It will not be able to assess if the probes are dirty, old, cracked, etc; so it is not necessarily an indication that the probes may not have other problems. If problems persist, replace the probe with a new or known-good probe.
Clear Tweaks	Menu/pH Menu/pH Tweak Menu/ORP Menu/ORP Tweak	Set tweak: to 0. Often problems with a pool are the result of "miscalibrated" probes. This screen shows the user's offset and the final reading. Under ideal circumstances the meter should read the water correctly without any tweak adjustment.
Clean Probes	At flow cell	See cleaning instructions. See page 52 -53
Check Dosers	pH Settings button/Override ORP Settings button/Override	Select [Dose] to turn on the appropriated doser. The doser selection is specified in the Configuration/ Hardware/pH Control and /ORP Control menus. Verify the pump is rotating properly and tubing is installed correctly. Check proper direction of flow. Pumps are labeled with IN and OUT and turn clockwise. One outlet is toward the front of the IntelliChem, the other is toward the wall. Verify pickup tube is all the way to the bottom of the container. Once verified, let the pumps run for a while to prime the tubing using the Dose Override feature. <b>WARNING!</b> Use extreme caution when handling pool chemicals. Verify the tubing is not clogged, kinked or punctured.
Chemicals	Supplies for the doser pump Set levels in pH/ORP Settings button or in the pH/ORP Supplies Menu.	Verify chemicals are fresh and of the proper concentration. Muriatic acid and Chlorine degrades within a matter of months or less depending on sunlight and temperature. Be sure the supply containers contain sufficient amounts of chemical. Set the Supplies level to correspond to the level in the tank. Once the indicator gets to the "0" level, the alarm will be set
Sat Index	Main menu, Sat Index	The Langelier Saturation Index is an indication of the overall water condition. Its calculation is based on water temperature, pH, salt, calcium hardness, and total alkalinity (to which cyanuric acid has a contributing factor). The results of this calculation are used to determine if the water is corrosive or scaling. Balanced water allows the pool chemicals to function properly and affects the ability of the sanitizer to do its job. If you're having problems with maintaining water clarity or sanitizer, check this or have a water sample professionally analyzed.
Balance Water		Balance water is the result of proper chemical treatment and care of the filtration
Replace Probes		If the probes have been cleaned and all other aspects of the pool operating properly. Try a new set of probes.
Repeat		After performing all these steps it may prove helpful to repeat all these steps

## Alarm Messages and Troubleshooting Tips

The IntelliChem is continually monitoring its own condition and that of the water chemistry. The following is a list of alarms and most likely causes. This should give you a good starting place for troubleshooting and resolving the alarm.

IntelliChem Message**	EasyTouch/IntelliTouch, Screen Logic	Troubleshooting Tips
SI Scaling / SI Corrosive	SI Scaling SI Corrosive	Water conditions indicate water has exceeded the threshold level. Refer to Langelier Saturation Index water balance information and the user settings in the <a href="#">Configuration/Preferences 2/2 page</a>
UOC Comm Err	Comlink Lost Communication Lost	Connection between IntelliChem and the automation controller. Check RS-485 4-wire connection, terminals, and cables.
Auto Calibration ...Failed	Auto Cal Failed Calibration Failed	Check that the printed circuit board is clean and dry. Dirt, condensation or water leaking into the enclosure will cause faulty readings.
Invalid EE CRC or Rev#	Memory Error	Turn unit off and on again. If problem persists reload firmware or replace circuit board.
SCG Comm Err	Salt Chlorine Generator Comm Error Salt Chlorine Generator Communication Error	The SCG device may not communicate if the water is too cold, not circulating, salt level is too low. It may also take from 2 to 10 minutes or more to begin communication. Sometimes this can be solved by cycling power to the SCG unit and waiting again. Check cable wires and terminals for proper connection.
pH/ORP Invalid Setup	Invalid Setting Invalid Hardware Config	This indicates incompatible settings in the pH setup. Check that the hardware configuration on pH Control page 1/2 and 2/2 correspond properly. That if you specify an internal pump, you've chosen one of the MTR_L/R devices, and if you've chosen an External doser, you've selected an external relay. Be sure you're not using the same output device for both pH and ORP or an alarm output. Check dosage, and supply settings. Check that if you are dosing by volume that you have provided the GPD of the doser.  If you are unable to resolve the problem, re-run the Auto Setup Wizard. When it prompts to use previous values be sure to choose <b>Reset All</b> .
pH/ORP Dose Limit	pH Dosage Limit ORP Dosage Limit pH Feed at Limit ORP Feed at Limit	This alarm will be the normal course of water chemistry control when experiencing a heavier than expected bather load, high temperature, or improperly balanced water. First check the saturation index and balance the water chemistry. Increase the dosage and filter time, increase the daily limit. During peak loads it may be easiest to administer chemicals by hand. The Limit can be manually cleared in the pH/ORP Settings menu, accessed by the appropriate button to the left side of the LCD display. It can also be programmed to clear automatically each time the IntelliChem powers on, or at every 24 hours of continuous run time in the pH/ORP Dosage 2/2 menu.
pH >7.8 Lockout	PH Lock Out Sanitizer Feed Locked	This is a safety feature that prevents over feeding sanitizer if the pH gets too high. As pH increases, the sanitizer becomes less effective. The proper thing to do is first reduce the pH and then see if you really need to add more sanitizer. Often bringing down the pH is sufficient to free more sanitizer.

\*\* Displayed in various places on the main screen



## Troubleshooting the alarm messages

Flashing pH/ORP tank/hourglass symbol	Check pH Tank Check ORP Tank	Refill the chemical supply container and set the gauge to the appropriate corresponding level. This alarm indicates level is low and should be refilled. If non-fluid supply sources are used, like CO2 and SCG, you can set a reminder in the pH/ORP Supplies 2/2 menu that will trigger this alarm as a reminder to change CO2 canisters or clean the SCG plates. The reminder is reset either in the Supplies 2/2 menu or the pH/ORP Settings button.
ORP LOW	ORP Is Too Low  ORP Reading Too Low	Increase filter time and increase dose size. This may be the result of the ORP Sensitivity setting. If the sensitivity is set to "Low", you may not have a sufficiently sized dose to reach the setpoint. Try turning Sensitivity to "High" or "Off".  Check overall water chemistry using the Saturation Index calculator or have water tested by a professional pool service person or dealer. Also, check that the dose dispensing device is operating properly and that your supply tank is full.
ORP HIGH	ORP Is To High  ORP Reading Too High	Overshooting ORP may simply be a result of Cyanuric acid in the pool which suppresses the ORP during the sunlight hours and releases chlorine at night. It may also be that dose size is set too high with insufficient mix time. Turning ORP Sensitivity to "Low" may help reduce overshooting.
pH LOW	PH Is Too Low  pH Reading Too Low	Overshooting pH may be due to the dose size being set too high with insufficient mix time. Turning pH Sensitivity to "Low" may help reduce overshooting. Test overall water chemistry using the Saturation Index calculator. Low Total Alkalinity may contribute to rapid pH swings and make controlling water nearly impossible. Consult your pool professional.  Check overall water chemistry using the Saturation Index calculator or have water tested by a professional pool service person or dealer. Also, check that the dose dispensing device is operating properly and that your supply tank is full.
pH HIGH	PH Is Too High  pH Reading Too High	Increase filter time and increase dose size. This may be the result of the pH Sensitivity setting. If the sensitivity is set to "Low", you may not have a sufficiently sized dose to reach the setpoint. Try turning Sensitivity to "High" or "Off".
NO FLOW DETECTED  Check pump, flow cell, filter, and valves.	No Flow	Ensure the pool pump is turned on, that valves are properly positioned, and that sufficient water is being directed to the flow cell. Make sure the magnet is properly contained in the flow tube and that the detector is wired properly to the Flow switch terminal block. The flow switch should be closed (shorted) to indicate flow.  Warning: This is a Safety Device. Do not operate the IntelliChem with the flow switch bypassed. Water flow must be present to ensure chemicals are mixed adequately to avoid dangerous gasses and high concentrations of chemicals near people or pool equipment.
Awaiting FLOW DELAY	Flow Delay	This is not an alarm, only a message indicating that water chemistry control will commence after this count-down timer expires. To allow pool water to stabilize and time for chemicals to activate, a minimum of 15 minutes is required to get accurate readings. The Flow Delay is set in the Configuration/Delays menu. It is the combination of the Power-On and Flow-Switch delay settings. As a convenience for the pool service person, you may bypass the delay by holding the Up Arrow button for 3 seconds. Please give time for the water to stabilize before expecting proper operation of the equipment.
pH has priority	PH Priority	This is not an alarm but a message that pH is feeding (acid) and that ORP (chlorine) is on hold until the acid feed is finished. This is enabled in the Configuration/Dose Priority menu on systems where the acid and chlorine may be injecting near the same point in the plumbing and the installer has decided, for safety reasons, to only feed one chemical at a time.

\*\* Displayed in various places on the main screen



## Cross Reference

IntelliChem Alarm Name	IntelliChem Message**	EasyTouch/IntelliTouch Message	Screen Logic Message
Scaling	+ .53 Scaling	SI Scaling	SI Scaling
Corrosive	-.41 Corrosive	SI Corrosive	SI Corrosive
UOC Comm Error	UOC Comm Err	Comlink Lost	Communication Lost
Calibration Failed	Auto Calib...Failed	Auto Cal Failed	Calibration Failed
Memory Error	Invalid EE CRC or Rev#	Memory Error	Memory Errors
SCG Comm Error	SCG Comm Err	IChlr Comm Error	IntelliChlor Communication Error
Invalid Setup	pH/ORP Invalid Setup	Invalid Setting	Invalid Hardware Config
ORP Dose Limit	ORP Dose Limit	ORP Dosage Limit	ORP Feed at Limit
PH Dose Limit	pH Dose Limit	PH Dosage Limit	pH Feed at Limit
PH Lockout	pH>7.8 Lockout	PH Lock Out	Sanitizer Feed Locked
ORP Chemical Empty	Flashing ORP tank symbol	Check ORP Tank	Check ORP Tank
PH Chemical Empty	Flashing pH Tank symbol	Check PH Tank	Check pH Tank
ORP Low alarm	ORP LOW	ORP Is Too Low	ORP Reading Too Low
ORP High alarm	ORP HIGH	ORP Is Too High	ORP Reading Too High
PH Low alarm	pH LOW	PH is Too Low	pH Reading Too Low
PH High alarm	pH HIGH	PH is Too High	pH Reading Too High
No Flow Alarm	No Flow Detected...	No Flow	No Flow
<b>Status "alarm" conditions</b>	Awaiting FLOW DELAY	Flow Delay	Flow Delay
	pH has priority	PH Priority	PH Priority

\*\* Displayed in various places on the main screen

## Tweaking pH (Calibrating Sensor)

Measure the pH using a standard test kit by taking several readings and averaging the results. To Tweak the pH sensor see page 14.

## Tweaking ORP (Calibrating Sensor)



### WARNING

Always make sure the pH is at the set point before calibrating ORP. Always control at PPM levels greater than 1.0 PPM when using ORP sensors.

**IMPORTANT:** For best results the ORP should be at the ORP set point when calibrating. For best results the PPM should be at the desired level when calibrating ORP. To Tweak the ORP sensor see page 17.

## Commercial IntelliChem Controller Specifications

### RATINGS:

Input Voltage:	120 VAC / 60 Hz - 3.6 A maximum
Relay Rating:	Dry Contact 5 A, 120 VAC / 30 VDC
Temperature:	Min./Max. Operating Temperature 30° - 110° F
Sensor Range:	pH 4.0 - 9.99 - ORP 0 - 999mV Flow Open or Closed

## MAINTENANCE

**Winterizing:** The Flow Cell sensors must be protected from freezing conditions. If the pool is winterized, plan to remove and store the sensors (as described above) as part of the normal pool winterizing process. The Flow Cell and related plumbing must be drained as well.

### Water Chemistry

Always test water chemistry with a quality manual test kit. Therefore, it may be preferable to calibrate pH using commercially available reference solutions. If required, use the IntelliChem Tweak pH feature to periodically adjust the pH reading (see above and page 12, 14, and 17). It's important to note that changes in pH, cyanuric acid concentration, total dissolved solids, and use of additional or alternative sanitizers will all affect the primary sanitizer residual level relative to ORP. Maintain total alkalinity on regular basis to ensure pH stability. To maintain a consistent sanitizer residual in parts per million (ppm), periodically adjust the ORP level.

**Sensor Maintenance:** The Flow Cell sensors must be clean and free from oil, chemical deposits and contamination to function properly. After saturation in pool or spa water, the sensors may need to be cleaned on a weekly or monthly basis depending on bather load and other pool specific characteristics. Slow response, increased need to calibrate pH, and inconsistent readings are indications that the probes are in need of cleaning.

## MAINTENANCE (Continued)

**Cleaning the Flow Cell Sensors:** To clean the ORP and pH sensors, turn off the AC source power to IntelliChem at the GFCI switch. Disconnect the probe connectors from the Flow Cell, unscrew the probe and carefully remove them from the Flow Cell. Clean the reference junction (the white ring at the bottom of the probe body) with a soft toothbrush. A household liquid dish washing detergent may also be used to remove any oil. Rinse with fresh water and reinstall probes. If properly cleaned probes continue to provide unstable readings or require excessive calibration, the probes should be replaced. Probe exposed to atmospheric conditions will cause the probe tips to dry out. Store the sensors with the included plastic sensors storage caps if removed from the Flow Cell for more than one hour. If the storage caps have been misplaced, store the probes individually in small glass or plastic containers with clean water covering the sensor tips. Store sensors in a location that will not be subjected to freezing temperatures.

### Sensor Care

Contamination of the sensing elements often results in slow response and inaccurate readings. Clean the elements by the following procedures:

#### pH and ORP Sensors

1. Wash electrode tip in a liquid detergent and water. Carefully use a soft bristled toothbrush to wash the electrode tip and white sensing ring.
2. Rinse after cleaning. To reinstall the flow cell (see page 33). Hand tighten to sensors to secure in place.
3. Make sure the O-ring is installed on sensor.
4. If the cable is longer than needed, it should be coiled neatly and attached under the enclosure.

#### pH Sensors Only

5. Attempt to clean the sensor with liquid detergent first.
6. If this is not successful, swirl the tip of the sensor in a 5 parts water and 1 part muriatic acid solution for 10 - 20 seconds.
7. Rinse again and reinstall.

**WARNING! Do not rub hard the glass element in the sensor or use sand paper or other polishing material to clean. HANDLE ELECTRODE CAREFULLY** Sensors contain external and internal glass elements. Do not drop or otherwise subject the sensor to vibration, physical impact, or freezing conditions. ANY TYPE OF BREAKAGE IS NOT COVERED UNDER WARRANTY.

**pH and ORP Sensors:** pH electrodes sense the acidity of the water and work with any acid or base. The blue bands on the cables identify the pH sensors. The red bands on the cables identify ORP sensors. Each sensor is also identified on the sensor body. ORP electrodes are used to monitor the Oxidation Reduction Potential (ORP is sanitization quality of the water) of a given solution. The sensing element of the ORP electrode is made of a precious metal such as platinum or gold.

**Sensors:** IntelliChem measures the following sensor measurements with the listed characteristics:

**pH Range:** 4.00 to 9.99

**ORP Range:** 0 to 999 mV

**Flow Switch:** This input measures if a switch is open or closed. Open is no water flow. A closed switch indicates flow.

## Stenner Pump Head Maintenance



**WARNING** Disconnect AC power to IntelliChem® Controller enclosure at the circuit breaker before servicing. Failure to do so could result in death or serious injury to serviceman, pool users or others due to electrical shock.

**Stenner Pump Head should be inspected every 30 days for signs of damage (Yellowing or cracking).**

**Annual replacement of the Stenner Pump Head tubing is highly recommended.**

**Refer to the Stenner Installation and Maintenance Manual for the Pump Tube Replacement procedure and other pump maintenance.**

### IntelliChem® Controller Flow Cell Replacement Parts List

1. P/N 522186 - Sensor, pH (\* 1 year warranty)
2. P/N 522187 - Sensor, ORP (\* 1 year warranty)
3. P/N 754000310 - Flow Cell with Flow Switch Sensors
4. P/N 521342Z - IntelliChem Controller Parts Bag (not shown)
5. P/N 754000440 - Flow Switch Sensor with Magnet  
P/N 754000410 - Magnet for Flow Switch
6. P/N 744000290 - Cable, pH 3 ft
7. P/N 744000360 - Cable, ORP 3 ft
8. P/N 754000340 - O-Ring for Flow Jar
9. P/N 754000350 - Flow Jar

Accessories:

P/N 521814 - 3/8" Black Tubing (optional)

#### \* Warranty Information

*The IntelliChem Controller pH Sensor and ORP Sensor each have a one year limited warranty.*

*The IntelliChem Controller pump head, pH Sensor and ORP Sensor are considered wear items and are covered by their own warranty periods and are not part of any extended warranty coverage.*

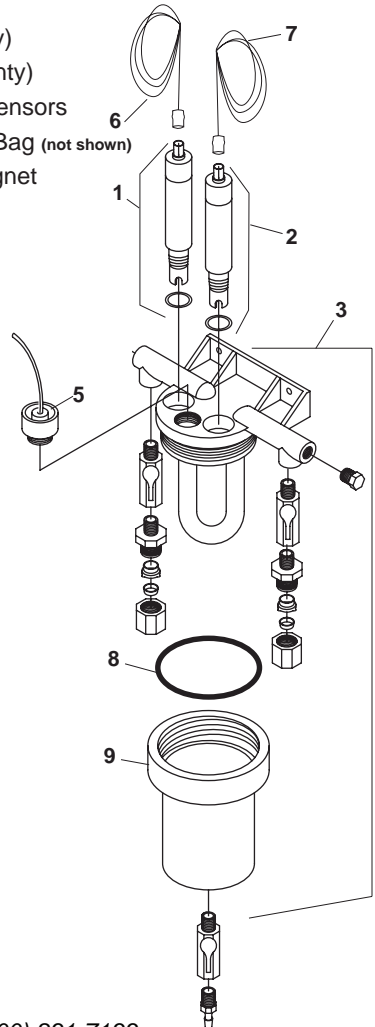

*For more information contact Customer Support (800) 831-7133*

## IntelliChem® Controller Kit Contents

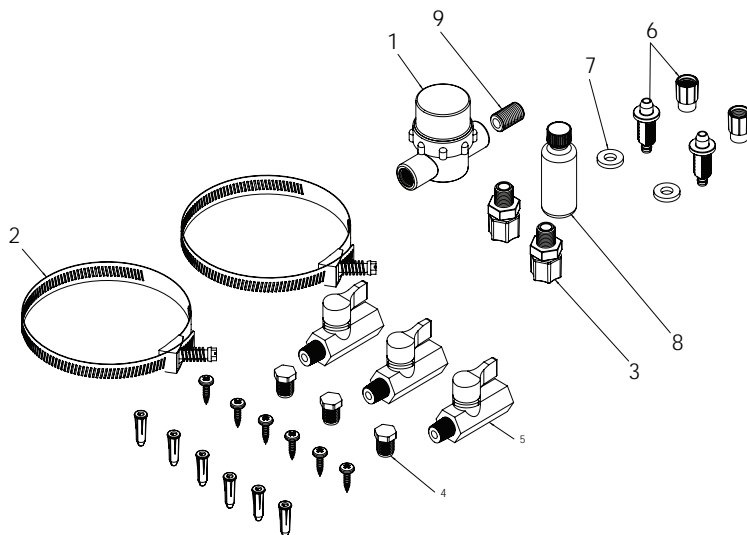

Item	QTY.	Part Number	Description
1	1	522010Z	FILTER INLINE STRAINER 1/4" FEMALE NPT
2	2	522347Z	CLAMP SADDLE ICHEM BYPAS
3	1	606000100Z	FTG 3/8" COMPRESSION X 1/4" NPT
4	1	620000040Z	FTG 1/4" NPT NYLON PLUG
5	3	622000080Z	1/4" NPT M/F BALL VALVE
6	2	R172032	TUBE FITTING WITH NUT
7	2	R172033	GASKET,.75 OD
8	1	R172036	LUBRICANT, SILICONE,3/4OZ
9	1	62000130Z	.25 NPT 7/8 CLOSE NIPL SC H80

## Commercial IntelliChem® Controller Additional Replacement Parts List

P/N 751000610	Stenner 10 GPD External Pump
P/N 522650	Stenner 10 Pump Tube - 2 Pack
P/N 522651	Stenner 10 Pump Tube - 5 Pack
P/N 522384	20 ft - 1/4 in Black Tubing for Chemical Injection with Labels
P/N 522446	100 ft - 1/4 in Black Tubing for Chemical Injection with Labels
P/N 714000070	CO2 Kit with Diffuser, Solenoid, Regulator
P/N 521622	IntelliChem Winterizing Kit
P/N 521498	IntelliChem Flash Programing Kit
P/N 522895	Injection Kit (Injection Check Valve)
P/N 521511	Saddle Clamp for 1-1/2-in Pipe (Required Check Valve)
P/N 521512	Saddle Clamp for 2-in Pipe (Required Check Valve)

## IntelliChem® Controller Replacement Parts List

1. P/N 521465Z - Top Half (Lid with overlay and wiring diagram).
2. P/N 521319Z - IntelliChem Controller Circuit Board.
3. P/N 8520031Z - Circuit Breaker.
4. P/N 521467Z - Enclosure mounting brackets.
5. P/N 521468Z - Strain relief kit.
6. P/N 521335Z - Replacement transformer with mounting plate.

### Warranty Information

The IntelliChem controller has a one year limited warranty.

For more information contact Customer Support (800) 831-7133

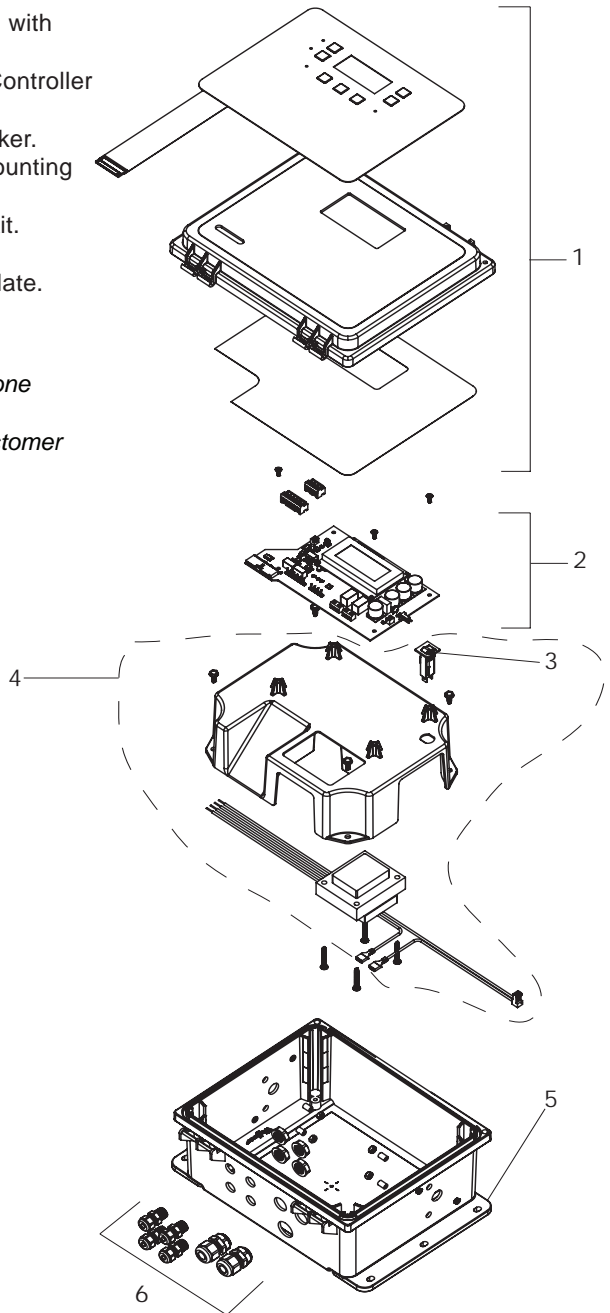

## Wireless Transceiver Replacement Parts List

1. P/N 523117 Transceiver Enclosure Replacement for Commercial IntelliChem Controller.

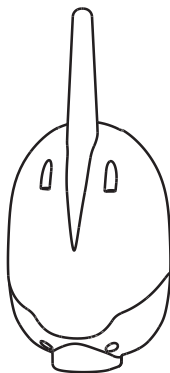

523117

## Connecting Remotely to the Commercial IntelliChem® Controller

Using the “ScreenLogic Connect” utility you can control your pool and spa operations remotely from your laptop computer over the Internet or from your local networked computer in your house. You can download the remote connection utility from [www.pentairpool.com](http://www.pentairpool.com).

**IMPORTANT! The IntelliChem Controller Auto Setup Wizard must run before connecting to the ScreenLogic2 Interface software**



### To connect remotely to your system:

1. After installing the “ScreenLogic Connect” utility, click the “ScreenLogic Connect” icon on your desktop to start the program.
2. Enter your the ScreenLogic2® Interface system name in the “System Name” box. The name must be entered as follows: Pentair: xx-xx-xx  
The Protocol Adapter Address (xx-xx-xx) is the last six digits of the Protocol Adapter serial number found on the Protocol Adapter.
3. In the “Password” box, enter the system password that you assigned in the “Set Remote Access Password” dialog in the “General Settings (step 1 of 5)” dialog box, or leave the box blank if no password has been assigned.
4. Click the “Remember Login info” check box to save your system name and password so that you don’t have to enter the information each time you want to connect.
5. Click the “Start ScreenLogic” button to connect to your system and start the ScreenLogic2 Interface. Click the “Options” button, then click the “Configure ScreenLogic” button if you want to configure your system using the “Configurator” utility.

### To connect to your system via your local network:

1. Enter your the ScreenLogic2 Interface system name in the “System Name” box. The name must be entered as follows: Pentair: xx-xx-xx  
The Protocol Adapter Address (xx-xx-xx) is the last six digits of the Protocol Adapter serial number found on the Protocol Adapter.
2. Click the “Options” button. The ScreenLogic2 Interface Connect program will recognize and automatically populate the system name in the “Local Systems” box.
3. Click the “Remember Login info” check box to save your system name and password so that you don’t have to enter the information each time you want to connect.
4. Click the “Start ScreenLogic” button to connect to your system and start the ScreenLogic2 Interface. Click the “Configure ScreenLogic” button if you want to configure your system via the “Configurator” utility.



## ScreenLogic2 Wireless Connection Kit

The ScreenLogic2 Wireless Connection kit (P/N 520639) consists of two wireless 900 Mhz transceivers which provides a wireless connection between the ScreenLogic2 Protocol adapter and the IntelliChem Controller. This wireless connection eliminates the existing hard wire connection from inside your home to the equipment pad.

The diagram below shows the wireless transceiver locations. The transceiver connected to the IntelliChem is connected to the other transceiver is connected to the Protocol Adapter located inside the home.

### ScreenLogic2 Location Requirements

The ScreenLogic2 Protocol adapter must be located inside in a dry environment, preferably near the home owner's DSL/Cable modem.

To ensure optimum wireless connection, placement of the existing wireless router inside the home is important. Ideally, the wireless router should be positioned in the room nearest to the pool and spa location or close to where the wireless Tablet, iPad, iPod or iPhone will be primarily used.

### Less walls and ceilings equals better wireless reception

Your existing wireless router allows the Digital Tablet, iPad, iPod, iPhone or a wireless laptop to access the ScreenLogic2 interface from anywhere in and around your home up to approximately 150 feet from the wireless router. However, keep in mind that range is limited by the number of walls, ceilings, or other objects that the wireless signals must pass through. Typical ranges vary depending on the types of materials and background RF noise in your home. The following information can help maximize the wireless transmission and reception range:

1. Keep the number of walls and ceilings between the wireless router and the Tablet, iPad, iPod or iPhone to a minimum - Each wall or ceiling can rob your wireless router of 3-90 ft. of range. Position your wireless router so that the number of walls or ceilings are minimized.=
2. Consider the direct line between your wireless router and Tablet, iPad, iPod or iPhone area of operation. A wall that is 1.5 feet thick, at a 45 degree angle, appears to be almost 3 feet thick to the wireless signal. At a two-degree angle it looks over 42 feet thick! Try to make sure that the wireless router is positioned so that the signal travels straight through a wall or ceiling for better reception.
3. Building materials make a difference - A solid metal door or aluminum studs may have a negative effect on range. Try to position the wireless router so that the signal passes through drywall or open doorways and not other materials.
4. Keep your wireless router away (at least 3-6 feet) from electrical devices that generate RF noise like microwaves, monitors, electric motors, UPS units, etc.
5. If you are using 2.4 GHz cordless phones or X-10 (wireless products such as ceiling fans, lights, and home security systems), your wireless connection might degrade dramatically or drop completely. Anything using the 2.4 GHz frequency could interfere with your wireless network.
6. For the average sized home, range should not be a problem. If you experience low or no signal strength in areas of your home that you wish to access, consider repositioning the wireless router.

**IMPORTANT NOTE ABOUT MULTIPLE WIRELESS CONTROLLERS IF YOU ARE USING MULTIPLE WIRELESS CONTROLLER SUCH AS:**

MobileTouch® or EasyTouch Control System Wireless Remote, or iS4 QuickTouch® Wireless Controller; be sure the Transceivers for each of these controllers are located at least 6 ft. apart from each other. This will avoid digital interference and ensure better wireless reception.

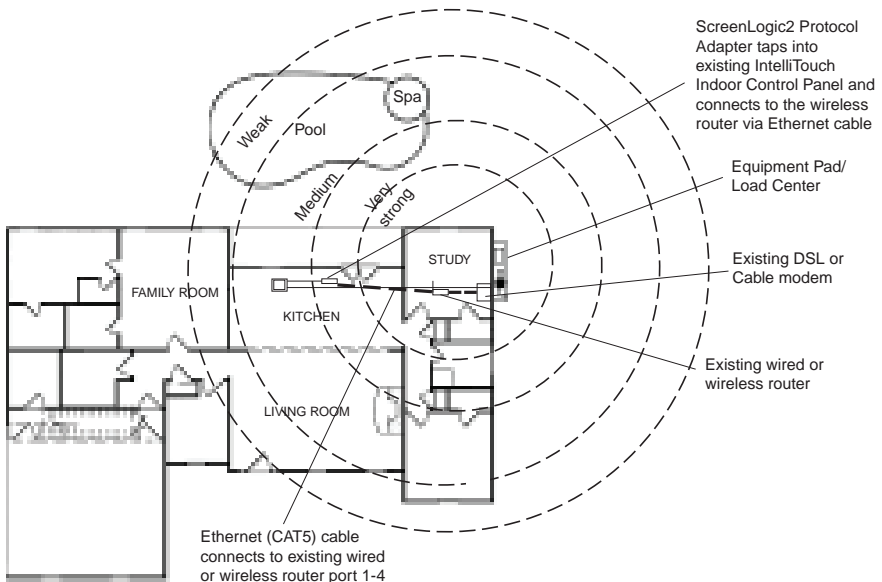
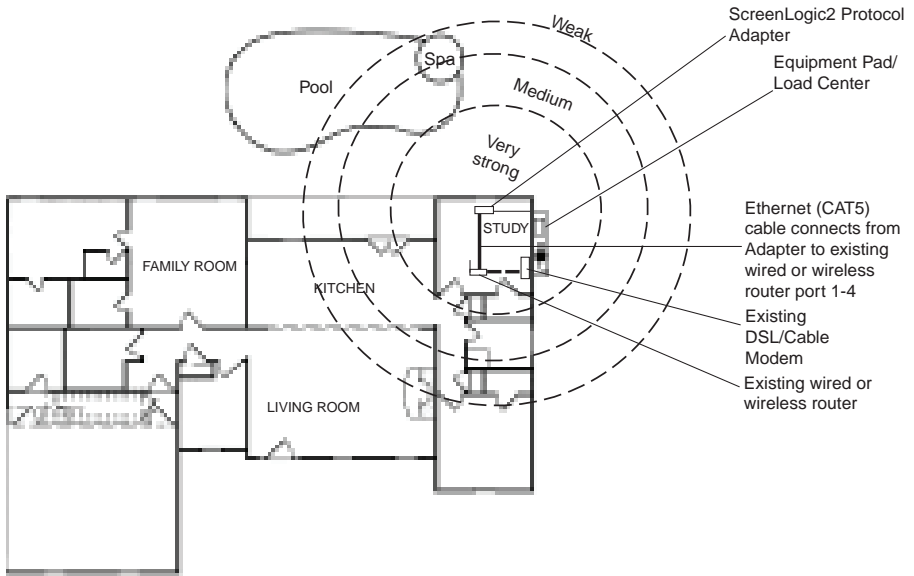

## ScreenLogic® Interface Connection Troubleshooting Hints

Use the following check list if “Connecting to Pool Controller ...Please Wait....” message is displayed.



1. If the IntelliChem Controller Auto Setup Wizard is waiting for your initial input, you must select a valid configuration. As soon as you enter the Auto Setup Wizard selection pages, SL2 should display the main screen shown below. There will be no readings until the configuration has been set and water flow has been established.
2. If the IntelliChem Controller sees any Keep Alive packets from automation once it starts up, you must disconnect from the automation network and reboot the IntelliChem controller.  
So if you inadvertently hook up to an automation system with an UIC/UOC even for a second, lchem will switch into slave mode and stop sending the KA. You could look at the R# code in the upper right corner of the Config/Diagnostics/Status Codes page; if the R# is other than 0, then it is in slave mode. Be sure the RS485 wiring is not routed to an UOC/UIC and power cycle the lchem.
3. The 4-wire comm cable must only be wired directly to the IntelliChem Controller and MUST also be supplied DC power from a separate adapter (Check for power LED on Protocol Adapter).
4. The IntelliChem Controller must be running version 2.008 or greater.
5. Must be using ScreenLogic2 Interface for IntelliChem Controller version 107 or greater

## Normal Operation

The following screens show normal operations showing the pool water reading and the Historical Data screen as shown below.



The data should begin to accumulate in the history page as new data becomes available. This data is stored on the Protocol Adapter in the HISTORY.DAT file. This file is cleared when the file system is reformatted and the new version Pentairupdate is installed. New data is only recorded when readings change by a certain amount or when events like a dose starting or ending are sensed. Data is also stored periodically throughout the day even if no changes are detected.

## Demo / Test Mode

If you don't have pH and ORP probes hooked up, IntelliChem can be put into demo mode by pressing and holding the UP or DOWN arrows on power up for a few seconds. You will see a display indicating Resistor Test Mode has been engaged and then the display will proceed to the calibration and regular display.

<b>Resistor Mode</b>	<b>Test - Engaged</b>
<b>pH=6.35</b>	<b>ORP=738</b>

Pressing the UP button will result in readings approximately  
pH=6.35, ORP= 738

Pressing the DOWN button will result in readings approximately  
pH=7.65, ORP=398

Note: You still have to satisfy the flow switch before readings are shown on the main display.

## Notes



## Notes



1620 HAWKINS AVE., SANFORD, NC 27330 • (919) 566-8000  
10951 WEST LOS ANGELES AVE., MOORPARK, CA 93021 • (805) 553-5000  
WWW.PENTAIRPOOL.COM

All Pentair trademarks and logos are owned by Pentair or one of its global affiliates. IntelliFlo®, MobileTouch®, EasyTouch®, IntelliTouch® and IntelliChem® are trademarks and/or registered trademarks of Pentair Water Pool and Spa, Inc. and/or its affiliated companies in the United States and/ or other countries. Unless expressly noted, names and brands of third parties that may be used in this document are not used to indicate an affiliation or endorsement between the owners of these names and brands and Pentair Water Pool and Spa, Inc. Those names and brands may be the trademarks or registered trademarks of those third parties. Because we are continuously improving our products and services, Pentair reserves the right to change specifications without prior notice. Pentair is an equal opportunity employer.

© 2017 Pentair Water Pool and Spa, Inc. All rights reserved. This document is subject to change without notice.



P/N 522669 Rev. C 3/2017