

WALLS

WALLS, PILLARS & PLANTERS



CHARACTERISTICS		ASTM C 1372	TECHO-BLOC
Compressive strength		3 000 psi [21 MPa] min.	5 050 psi [35 MPa] min.
Durability to freeze thaw cycles Mass loss		after 100 cycles 1 % (max.)	after 100 cycles 1 % (max.)
		after 150 cycles 1,5 % (max.)	after 150 cycles 1,5 % (max.)
Water absorption		13 lb/ft ³ [208 kg/m ³] max	9 lb/ft ³ [144 kg/m ³] max.
Dimension tolerance ¹	length	± 1/8" [3 mm]	± 1/8" [3 mm]
	width	± 1/8" [3 mm]	± 1/8" [3 mm]
	height	± 1/8" [3 mm]	± 1/16" [1.5 mm]

Notes : 1. The dimension tolerance is not applicable to split facings or other architectural finish.

2. The dimensional tolerance for Stonedge wet cast retaining wall units is: ± 3/16" (5 mm) for height and ± 1/2" (13 mm) for length and width. During the installation, the level between adjacent wall units will vary (usually more than for a dry cast wall unit) in order to obtain a more realistic appearance of a natural stone wall. Stonedge collection of wet cast wall units include, but are not limited to, the following: Borealis, Prescott, Röcka and Travertina Raw wall units.

Installation guide

SUMMARY OF CHARACTERISTICS

Type of wall	GRAVITY RETAINING WALL										
	Inclined Wall [1]			MAXIMUM TOTAL HEIGHT [2,3,4]						MINIMUM WALL RADIUS [5]	
	Angle	Setback		Inclined			Vertical				
	°	mm	in	# rows	mm	ft	# rows	mm	ft	m	ft
Baltimore 90 mm	4.4	7.0	9/32"	10	900	2' - 11"	8	720	2' - 4"	2.3	7' - 6"
Baltimore 180 mm	4.4	14.0	9/16"	5	900	2' - 11"	4	720	2' - 4"	2.3	7' - 6"
Borealis	0.0	0.0	0"	-	-	-	4	610	2'	-	-
Brandon 90 mm [8]	4.4	7.0	9/32"	10	900	2' - 11"	8	720	2' - 4"	2.3	7' - 6"
Brandon 180 mm [8]	4.4	14.0	9/16"	5	900	2' - 11"	4	720	2' - 4"	2.3	7' - 6"
Escala 3.5"	4.4	7.0	9/32"	10	900	2' - 11"	8	720	2' - 4"	2.3	7' - 6"
Graphix	Variable			8	600	2'	-	-	-	-	-
G Force	3.9	14.0	9/16"	5	1015	3' - 4"	-	-	-	3.0	9' - 10"
Manchester [9]	0.0	0.0	0"	-	-	-	5	500	1' - 8"	-	-
Mini-Creta 3" [8]	5.3	7.0	9/32"	12	900	2' - 11"	10	750	2' - 6"	2.1	7'
Mini-Creta 6" [8]	5.3	14.0	9/16"	6	900	2' - 11"	5	750	2' - 6"	2.1	7'
Prescott 2.25" [8]	4.5	4.5	3/16"	16	914	3'	12	686	2' - 3"	1.6	5' - 2"
Prescott 4.5" [8]	4.5	9.0	11/32"	8	914	3'	6	686	2' - 3"	1.6	5' - 2"
Raffinato 90 mm [8]	4.4	7.0	9/32"	10	900	2' - 11"	8	720	2' - 4"	2.6	8' - 6"
Raffinato 180 mm [8]	4.4	14.0	9/16"	5	900	2' - 11"	4	720	2' - 4"	2.6	8' - 6"
Röcka	0.0	0.0	0"	-	-	-	4	610	2'	-	-
Semma [8]	7.6	20.0	25/32"	7	1050	3' - 5"	5	750	2' - 6"	2.1	7'
Suprema	4.5	16.0	5/8"	5	1016	3' - 4"	4	813	2' - 8"	1.8	6'
Travertina Raw [8]	5.2	14.0	9/16"	5	762	2' - 6"	4	610	2'	-	-

- [1] Vertical Retaining walls are constructed without any face inclination or setback.
- [2] Heights do not include cap thickness.
- [3] - Total Height is the vertical distance measured from the top of the footing (aggregate base) to the top of the uppermost course.
 - Exposed Height is the vertical distance measured from the finished grade at the bottom of the wall to the top of the uppermost course. It does not include the wall depth below grade (embedment).
- [4] The maximum wall height for gravity retaining walls recommended in this table is based on the following conditions:
 - The retained soil type considered is gravel with an internal friction angle of at least 36°.
 - There is no surcharge load applied on top of the wall.
 - There is no slope on top of the wall.
 - An adequate drainage system is provided at the back of the wall.
- [5] Minimum retaining wall radius is measured at the front face of the wall. It corresponds to the lowest course in an internal curve and to the uppermost course in an external curve.
- [6] Freestanding Minimum Wall radius based on the shortest tapered unit.
- [7] The maximum height does not necessarily correspond to the amount of blocks in a pallet.
- [8] Pillar units sold separately.
- [9] Freestanding Maximum Height of 750 mm (29 7/16") is based on a block depth of 300 mm (11 13/16")

Installation guide

SUMMARY OF CHARACTERISTICS

Type of wall	FREESTANDING WALL						PILLARS			
	MAXIMUM EXPOSED HEIGHT [2,3]		MINIMUM WALL RADIUS [6]				MAXIMUM PERMISSIBLE HEIGHT [2,3,7]			
			inside		Outside		Exposed		Total	
	mm	in	mm	in	mm	inc	mm	in	mm	in
Baltimore 90 mm	750	29 7/16"	1202	47"	1473	58"	-	-	-	-
Baltimore 180 mm	750	29 7/16"	1202	47"	1473	58"	-	-	-	-
Borealis	612	24"	-	-	-	-	-	-	-	-
Brandon 90 mm [8]	750	29 7/16"	1538	61"	1788	70"	930	36 1/2"	1080	42 1/2"
Brandon 180 mm [8]	750	29 7/16"	1538	61"	1788	70"	930	36 1/2"	1080	42 1/2"
Escala 3.5"	750	29 7/16"	1108	44"	1360	54"	-	-	-	-
Graphix	600	23 1/2"	-	-	-	-	1050	41 1/4"	1200	47 1/4"
G Force	-	-	-	-	-	-	-	-	-	-
Manchester [9]	750	29 7/16"	-	-	-	-	1050	41 1/4"	1200	47 1/4"
Mini-Creta 3" [8]	750	29 7/16"	907	36"	1158	46"	1050	41 1/4"	1200	47 1/4"
Mini-Creta 6" [8]	750	29 7/16"	907	36"	1158	46"	1050	41 1/4"	1200	47 1/4"
Prescott 2.25" [8]	650	25 1/2"	863	34"	1114	44"	993	39"	1143	45"
Prescott 4.5" [8]	650	25 1/2"	863	34"	1114	44"	993	39"	1143	45"
Raffinato 90 mm [8]	750	29 7/16"	2259	89"	2510	99"	930	36 1/2"	1080	42 1/2"
Raffinato 180 mm [8]	750	29 7/16"	2259	89"	2510	99"	930	36 1/2"	1080	42 1/2"
Röcka	612	24"	-	-	-	-	-	-	-	-
Semma [8]	750	29 7/16"	519	20"	807	32"	1050	41 1/4"	1200	47 1/4"
Suprema	-	-	-	-	-	-	-	-	-	-
Travertina Raw [8]	764	30"	-	-	-	-	1069	42"	1219	48"

- [1] Vertical Retaining walls are constructed without any face inclination or setback.
- [2] Heights do not include cap thickness.
- [3] - Total Height is the vertical distance measured from the top of the footing (aggregate base) to the top of the uppermost course.
 - Exposed Height is the vertical distance measured from the finished grade at the bottom of the wall to the top of the uppermost course. It does not include the wall depth below grade (embedment).
- [4] The maximum wall height for gravity retaining walls recommended in this table is based on the following conditions:
 - The retained soil type considered is gravel with an internal friction angle of at least 36°.
 - There is no surcharge load applied on top of the wall.
 - There is no slope on top of the wall.
 - An adequate drainage system is provided at the back of the wall.
- [5] Minimum retaining wall radius is measured at the front face of the wall. It corresponds to the lowest course in an internal curve and to the uppermost course in an external curve.
- [6] Freestanding Minimum Wall radius based on the shortest tapered unit.
- [7] The maximum height does not necessarily correspond to the amount of blocks in a pallet.
- [8] Pillar units sold separately.
- [9] Freestanding Maximum Height of 750 mm (29 7/16") is based on a block depth of 300 mm (11 13/16")

Retaining Wall

PRELIMINARY DESIGN ASSISTANCE - REQUEST FORM

Techo-Bloc can help you in your preliminary design of retaining walls. However, preliminary design should only be used to assess the suitability of a wall system to a specific project or for estimating budget costs. For final construction designs, please contact a qualified engineer in your area.

Techo-Bloc Sales Representative _____ Date _____

Customer type: Landscape Architect Engineer Contractor Homeowner Other: _____ Are you a Techo-Pro? Yes No _____

1. GENERAL PROJECT INFORMATION

Project Name _____ Address _____

Contact _____ E-mail _____ City _____

Entreprise _____ Telephone _____ State / Province _____

Postal Code _____

2. PROJECT SPECIFICATIONS

Type: Industrial Commercial Institutional Residential Information date required _____ Units (metric or imperial) _____

2.1 SPECIAL CONSIDERATIONS

Maximum available space behind wall: _____

Maximum required freestanding wall portion: _____

3. GENERAL INFORMATION ON WALLS

3.1 SINGLE WALL

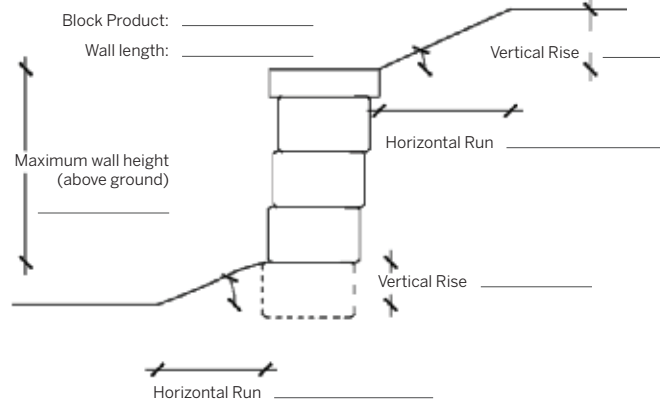

*Include only the Retaining portion of the wall. Freestanding portion must be included in section 2.1 under Project Specification.

**If a grading plan is available, include it with this request (drawing should indicate the location of the wall, grade lines and loads). Otherwise clear and detailed sketches must be provided.

3.2 TIERED WALL

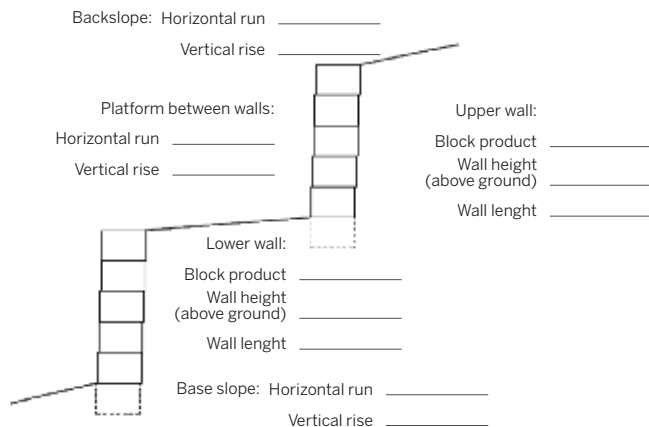

4. TYPE OF SOIL

If a soil report is available, attach it to this request.

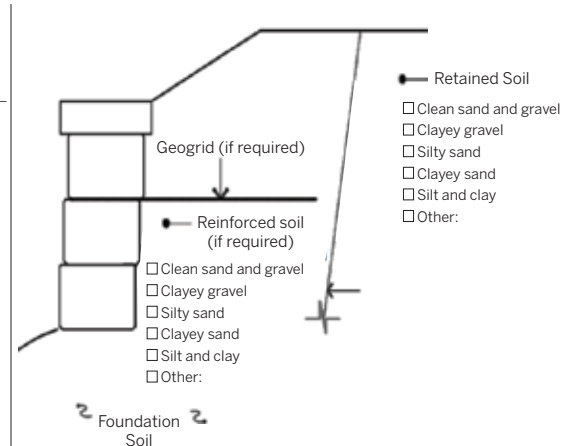

- Clean sand and gravel
- Clayey gravel
- Silty sand
- Clayey sand
- Silt and clay
- Other: _____

5. SURCHARGE ABOVE WALL

TYPE OF SURCHARGE (LOAD)

DISTANCE TO WALL

- Route _____
- Parking / alley for heavy vehicles _____
- Parking / alley for light vehicles _____
- Swimming pool _____
- Paved surface _____
- Lawn _____
- Other _____

Return this request by one of the following methods:

Fax 450 656-1983 | Email walls@techo-bloc.com | Mail Techo-Bloc - 5255 Albert-Millichamp Street, Saint-Hubert, QC J3Y 8Z8

Compatibility Charts

WALLS & PILLARS	CAPS																
	Architectural cap	Brandon	Bullnose	Bullnose Grande	Escala 3.5"	Graphix cap	Piedimonte	Piedimonte 28" x 28"	Portofino	Prima 14"	Raffinato 60 mm	Raffinato 90 mm	Travertina Raw 12" x 30"	Travertina Raw 14" x 28"	York	York 28" x 28"	York 32" x 32"
Baltimore 90 & 180 mm	●	●		●			●		●	●	●	●	●	●	●		
Borealis does not require a cap																	
Brandon 90 & 180 mm		●	●	●			●		●		●		●	●	●		
Brandon 90 & 180 mm pillar								●			●		●			●	
Escala 3.5"	●	●	●	●	●	●	●		●	●	●	●	●	●	●		
G-Force						●	●			●	●	●	●	●	●		
Graphix						●	●			●	●	●	●	●	●		
Manchester	●						●		●	●	●	●	●	●	●		
Mini-Creta Collection	●	●	●	●			●		●	●	●	●	●	●	●		
Mini-Creta Pillar 24" Collection								●			●		●			●	
Prescott Collection							●		●		●	●	●	●	●		
Prescott Pillar Collection								●			●		●			●	
Raffinato Collection				●		●	●				●	●	●	●	●		
Raffinato Pillar Collection								●			●	●	●	●	●		
Röcka does not require a cap																	
Semma	●	●	●			●	●		●	●	●	●	●	●	●		
Semma Pillar											●		●				●
Suprema						●	●		●	●	●	●	●	●	●		
Travertina Raw	●	●	●	●		●	●		●	●	●	●	●	●	●		
Travertina Raw pillar											●	●	●	●	●		●

NOTE: The combinations shown in this chart are not complete. Other possible combinations exist.

APPLICATIONS	CAPS																							
	Architectural cap	Bali Travertina Raw	Brandon cap	Bullnose	Bullnose Grande	Escala	Graphix cap	Piedimonte 12" x 30"	Piedimonte 14" x 30"	Piedimonte 28" x 28"	Portofino	Prima 14"	Raffinato 60 mm	Raffinato 90 mm	Travertina Raw 12" x 30"	Travertina Raw 14" x 28"	York wall caps 16", 32", 48"	York 14" x 48"	York 24" x 36"	York 28" x 28"	York 32" x 32"	Blu 45 mm	Venetian	
Step	●		●	●	●	●	●	●		●	●	●	●	●	●	●	●	●						
Concrete & step overlay system													●										●	●
Pool coping		●		●	●			●	●		●		●	●	●	●	●							
Wall single-sided	●		●	●	●		●	●	●		●	●	●	●	●	●	●	●						
Wall double-sided	●				●		●	●	●		●	●	●	●	●	●	●	●						
Counter top								●	●								●		●	●	●			
Pillar									●			●			●				●	●	●			

LEGEND: ● NEW PRODUCT

Installation guide

RETAINING WALLS

Installation outline

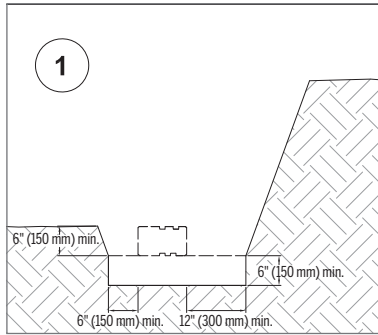

01 EXCAVATION

- Check the location of existing structures and utilities before starting the excavation.
- Dig out a trench. Its depth should be calculated according to the thickness of the leveling pad and the burial depth of the wall.
- Plan for a thickness of at least 6" (150 mm) for the leveling pad and consider that at least 10% of the height of the wall should be buried in the ground. In all cases, the wall must be buried no less than 6" (150 mm) deep.
- In determining the width of the trench, allow for a space of at least 6" (150 mm) at the front of the wall and 12" (300 mm) at the back for drainage fill. Compact and level the excavation base.

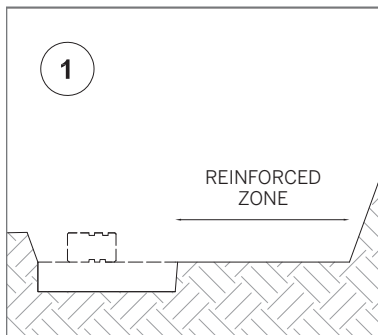

FOR GEOGRID REINFORCED RETAINING WALLS

The excavation must also take into account the length of geogrid.

02 FOUNDATION

- Cover the base and back of the trench with a geotextile. Extend the geotextile towards the back of the excavation and eventually above the drainage fill once it is in place close to the top of the wall.
- Next, spread the 0-3/4" (0-20 mm) stone in the trench and compact using a vibratory plate or jumping jack, ensuring that the surface is level. The compacted leveling pad must be at least 6" (150 mm) thick.

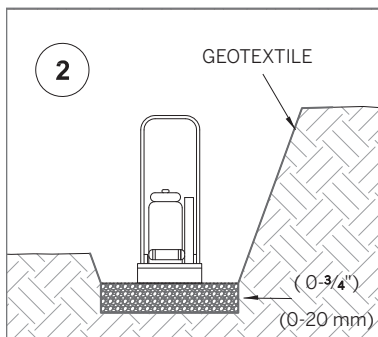

NOTE FOR STEPPED FOUNDATION

A wall built on an incline requires stepped foundations. For steep inclines, several steps may be required. Construction should start at the lowest level. Each of the steps must follow a level horizontal path and the vertical distance separating the successive steps must equal the height of a block.

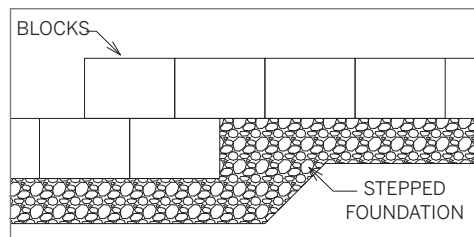

Installation guide

RETAINING WALLS

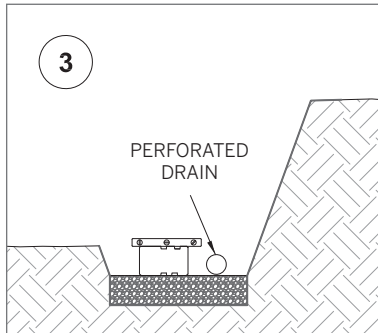

03 BUILDING THE FIRST COURSE

- Using blocks of the same height, place the first course on the compacted leveling pad according to the predetermined layout. Check the alignment and leveling in all directions and make sure that all the blocks are in full contact with the leveling pad and properly supported.
- Place the exposed surfaces of the blocks side by side. There must be no space between the exposed faces of adjacent blocks.
- At the back of the wall and on the compacted leveling pad, lay a 4" (100 mm) diameter perforated drain. Connect this drain to the existing drainage system so that it clears the water accumulated behind the wall.

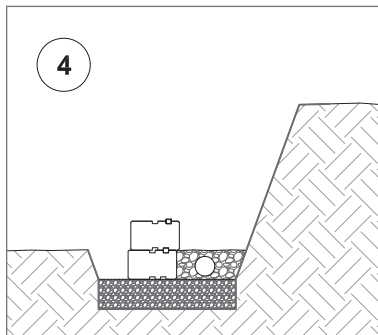

04 BACKFILLING

Backfill at the rear of the wall and the space between the back of the blocks with $\frac{3}{4}$ " (20 mm) clean stone. Level and settle the clean stone. Any cavities in the blocks must also be filled with clean stone.

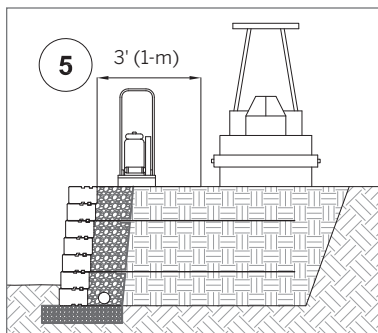

05 SUBSEQUENT COURSES

- Clean the top of each block before laying the next course. Depending on the type of block, install the connectors on the extremity of each block.
- Lay the subsequent courses, backfilling at the rear of the wall every 8" (200 mm) maximum, using the same method outlined in step 4.
- Make sure the subsequent courses are laid such that the vertical seams are aligned with the blocks below.



FOR GEOGRID REINFORCED RETAINING WALLS

Where geogrids are to be used, cover the clean stone with a geotextile. Select the geogrid according to the type, level and appropriate length. Position the geogrid according to the main reinforcement direction perpendicular to the wall. The geogrid must be continuous all along its embedment length. Splicing of the geogrid in the main reinforcement direction is not permitted. The geogrid must be installed horizontally over the compacted backfill and the previous course of blocks. Fix the connectors on the geogrid and lay the next course of blocks. Pull on the back of the geogrid and maintain its tension by stakes or pins. Repeat with a new section of geotextile and place the reinforced backfill directly behind the drainage fill. Fill and compact up to the level of the blocks.

Heavy equipment must not be used less than 3' (1-m) behind the blocks. Construction equipment must not drive directly over the geogrid.

Repeat the various installation steps.

06 FINISHING

Position the course of coping stones (if applicable) or the final course of blocks to complete the wall. The coping stones or final course of blocks must be fixed to the subjacent blocks using concrete adhesive and there must be no space between the blocks.

Installation guide

RETAINING WALLS

WALL INSTALLATION – GRAVITY WALL

Typical cross section

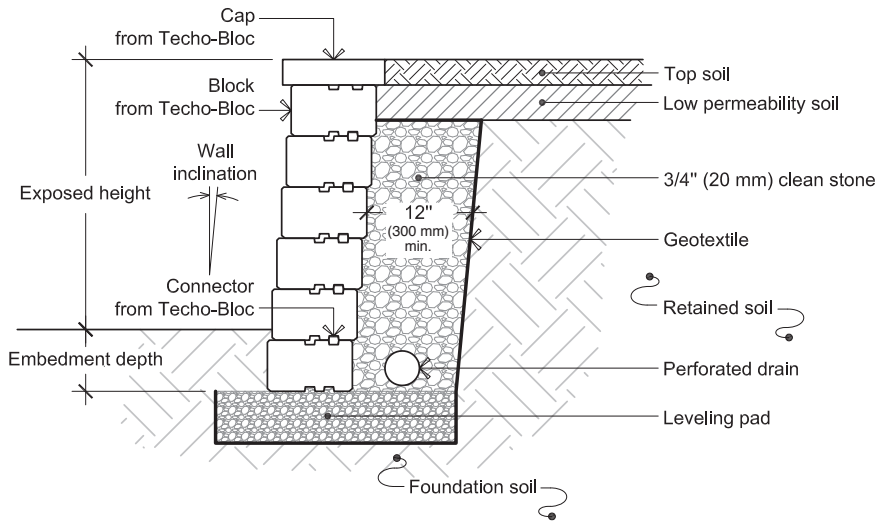

WALL INSTALLATION – GEOGRID REINFORCED WALL

Typical cross section

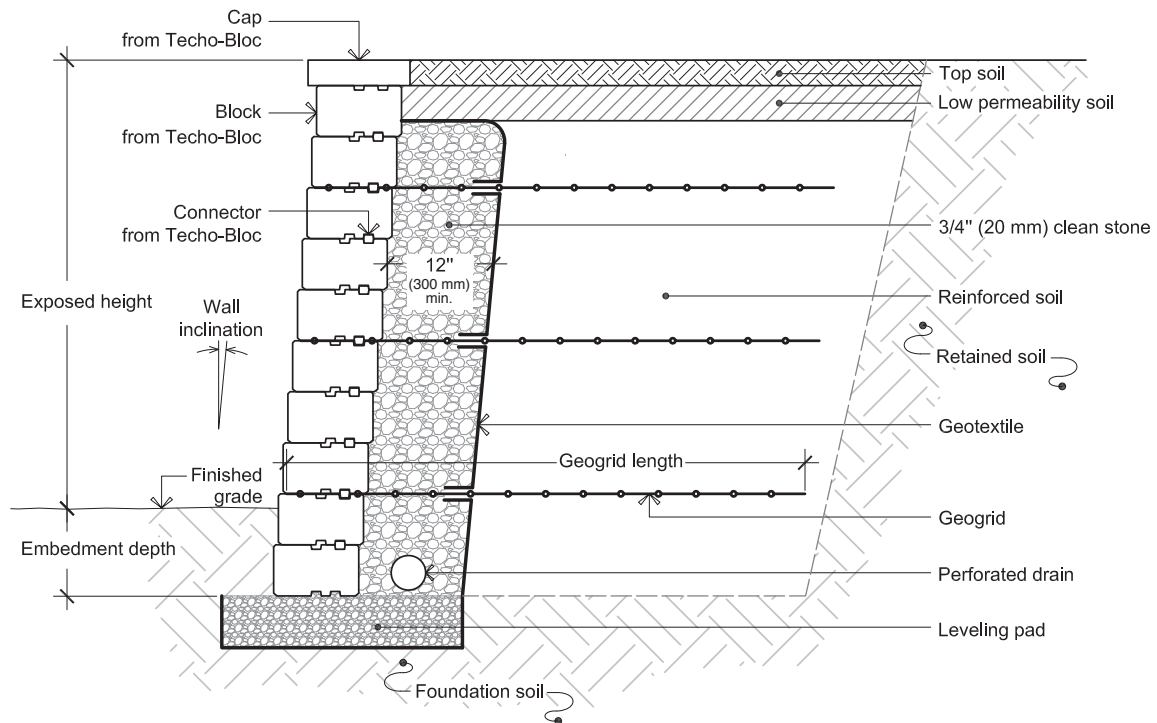

Design Charts

RETAINING WALLS

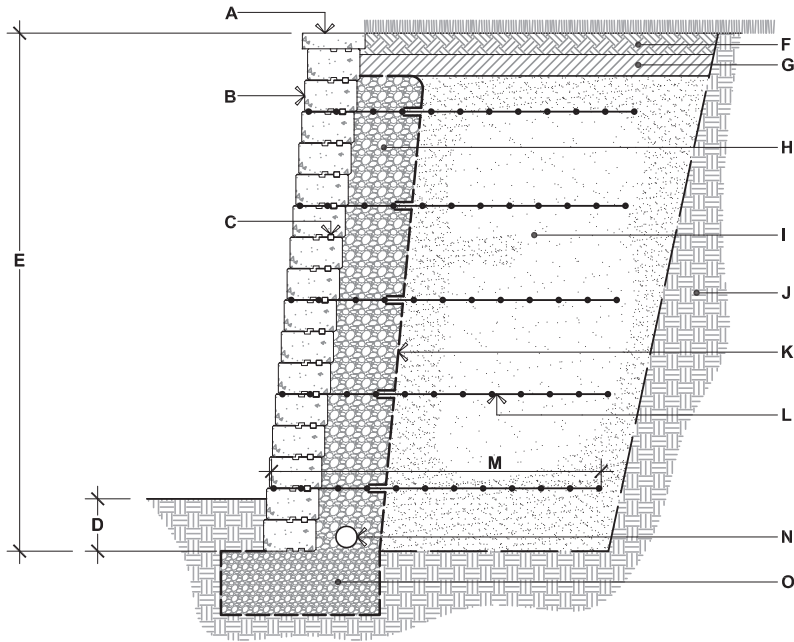

- A.** CAP UNIT FROM TECHO-BLOC
- B.** TECHO-BLOC WALL UNIT
- C.** CONNECTOR
- D.** EMBEDMENT DEPTH LARGEST: 8" (200 mm) OR 10% OF THE HEIGHT ABOVE GROUND MIN.
- E.** TOTAL HEIGHT (VARIABLE)
- F.** TOPSOIL
- G.** LOW PERMEABILITY SOIL
- H.** CLEAN STONE $\frac{3}{4}$ " (20 mm) PLACED 12" (300 mm) MIN. WIDE BEHIND WALL
- I.** REINFORCED SOIL COMPACTED
- J.** RETAINED SOIL
- K.** GEOTEXTILE
- L.** GEOGRID
- M.** GEOGRID LENGTH
- N.** PERFORATED DRAIN 4" (100 mm) Dia.
- O.** LEVELING PAD CRUSHED STONE 0- $\frac{3}{4}$ " (0-20 mm) COMPACTED

 **WALL INSTALLATION - GEOGRID REINFORCED WALL**
Typical cross section

The information contained in the design charts is supplied for information purposes only and as such should only be used for preliminary designs. A qualified engineer should be consulted for the final design to be used for construction. TECHO-BLOC and its predecessors, successors, beneficiaries, employees, associates, administrators and insurers can not under any circumstances be held liable for the incorrect use of information contained in the design charts.

The design charts show the number, position and length of the geogrids for a Techo-Bloc inclined wall based on the height of the wall and the load conditions. Furthermore, geogrid may be required for walls with a height lower than the minimum stated. The geogrid layout has been optimized to satisfy the minimum design requirements of the "Design Manual for Segmental Retaining Walls, 3rd Edition" from the National Concrete Masonry Association.

The height (H) of the wall is the total height from the leveling pad to the top of the wall including the coping stones of 75 mm (2.95 in) thick. The wall height varies approximately from 0.6 m (1.97 ft) to 2.5 m (8.20 ft), gradually increasing in height increments of 0.4-0.8 m (1.31-2.62 ft). The type of soil assumed in the reinforced soil zone (reinforced backfill) is a mixture of sand and gravel (minimum friction angle of 36°). The description of the soil is provided for information purposes; it is the actual shear strength parameter that will govern the design.

THE TWO LOAD CONDITIONS ARE:

- (i) A horizontal surface above the wall with a surcharge of 6 kPa (125 psf).
- (ii) A 1V:3H slope above the wall.

The ~~XXX~~ symbol shows the position and length of the geogrid taken from the front of the block. The height of the wall and the length of the geogrid are given in millimeters.

The foundation soil must be able to support the wall-reinforced backfill system. A geotechnical study to ascertain the bearing capacity of the soil must be carried out. The leveling pad is made of 0-20 mm (0- $\frac{3}{4}$ in) crushed stone. A concrete pad can be used. Compaction must be carried out in successive layers of a maximum of 8 in (200 mm) in thickness and in accordance with project specifications. The minimum burial depth must be 200 mm (8 in) or 10% of the above ground wall height, whichever is greater.

For further information, please contact our technical service department.

Email: WALLS@TECHO-BLOC.COM
Web site: WWW.TECHO-BLOC.COM

Design Charts

RETAINING WALLS

THE DESIGN CHARTS FOR:

- **BALTIMORE**: page 119
- **BRANDON**: page 130
- **ESCALA**: page 140
- **MINI-CRETA**: page 158
- **RAFFINATO**: page 181
- **SEMMA**: page 192
- **SUPREMA**: page 196

Installation guide

RETAINING WALLS

Anchoring system

BALTIMORE, MINI-CRETA, SEMMA AND SUPREMA BLOCKS

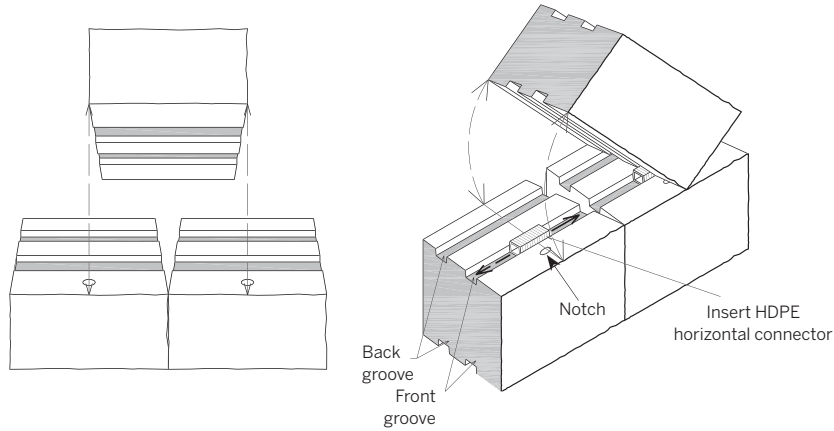

BALTIMORE, MINI-CRETA AND SUPREMA BLOCKS

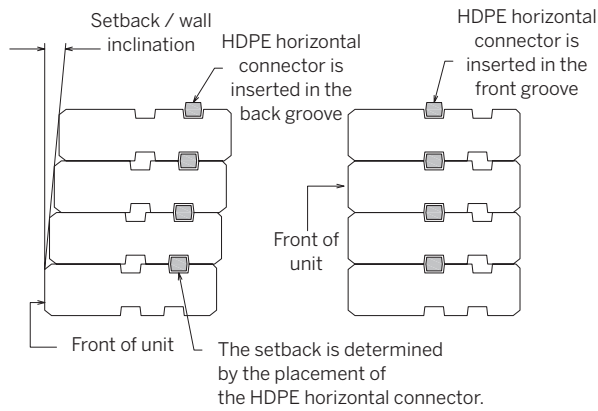

GRAPHIX

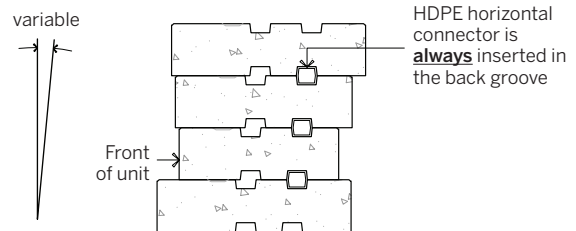

SEMMA

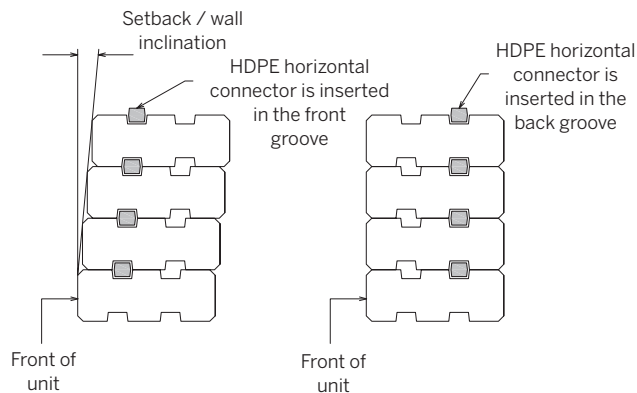

Installation guide

RETAINING WALLS

Anchoring system | Connectors in curved wall application

When creating internal curves and the connectors are in the back groove, two connectors must be installed on each block as illustrated.

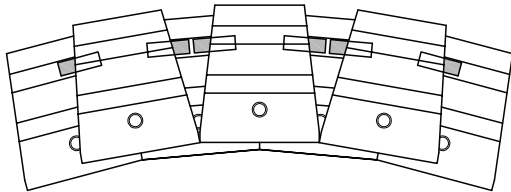

Anchoring system | Connectors in geogrid reinforced wall application

When using a geogrid, it must be placed above the connectors. The connectors will therefore be placed before the geogrid. After positioning the geogrid, move the block (from the above course) forward until it touches the connectors and ensures that the system is locked.

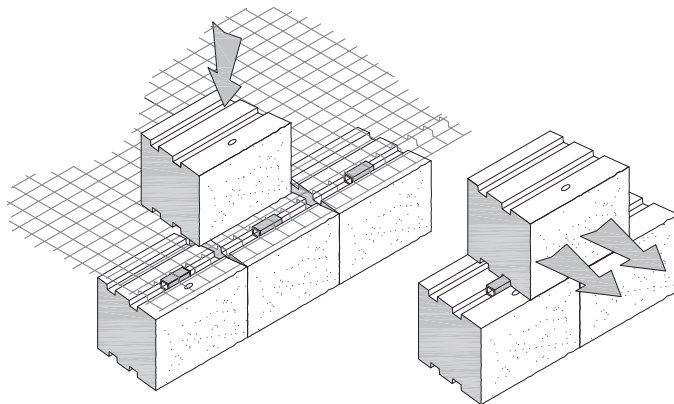

PRESCOTT BLOCKS

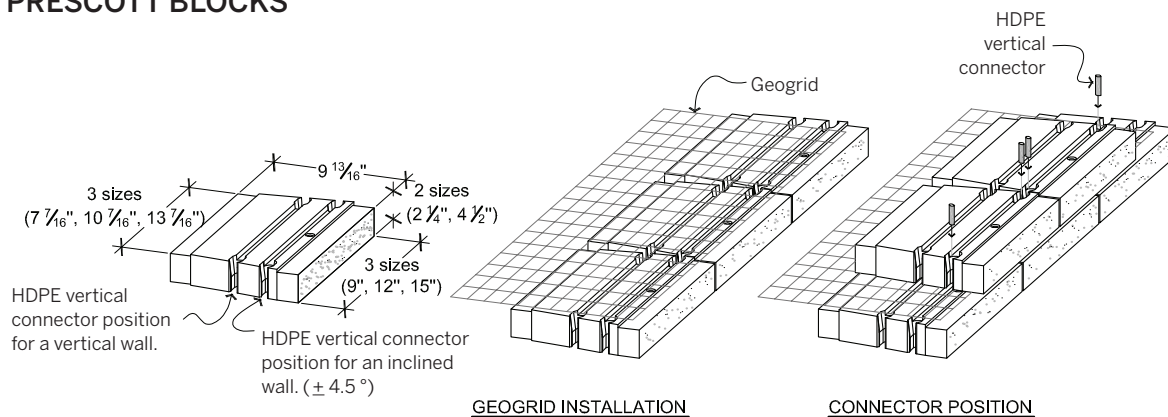

Note: It is recommended to install the connectors for an inclined wall when a geogrid is required.

Installation guide

RETAINING WALLS

BRANDON & RAFFINATO BLOCKS

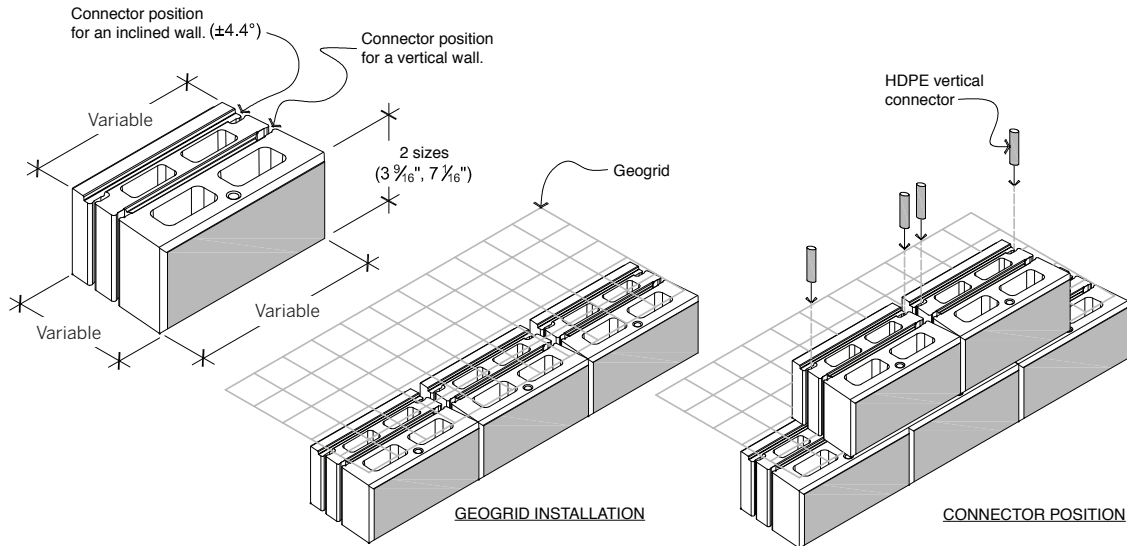

Note: It is recommended to install the connectors for an inclined wall when a geogrid is required.

Internal corner

When building a wall with an internal corner, it is recommended to start constructing the wall at the corner and build out from this point in both directions. To form the corner, use the longer modules as illustrated. Build wall B by extending it out from wall A so the end of wall B is aligned with the back of wall A. For subsequent courses, simply alternate the extension of walls A and B.

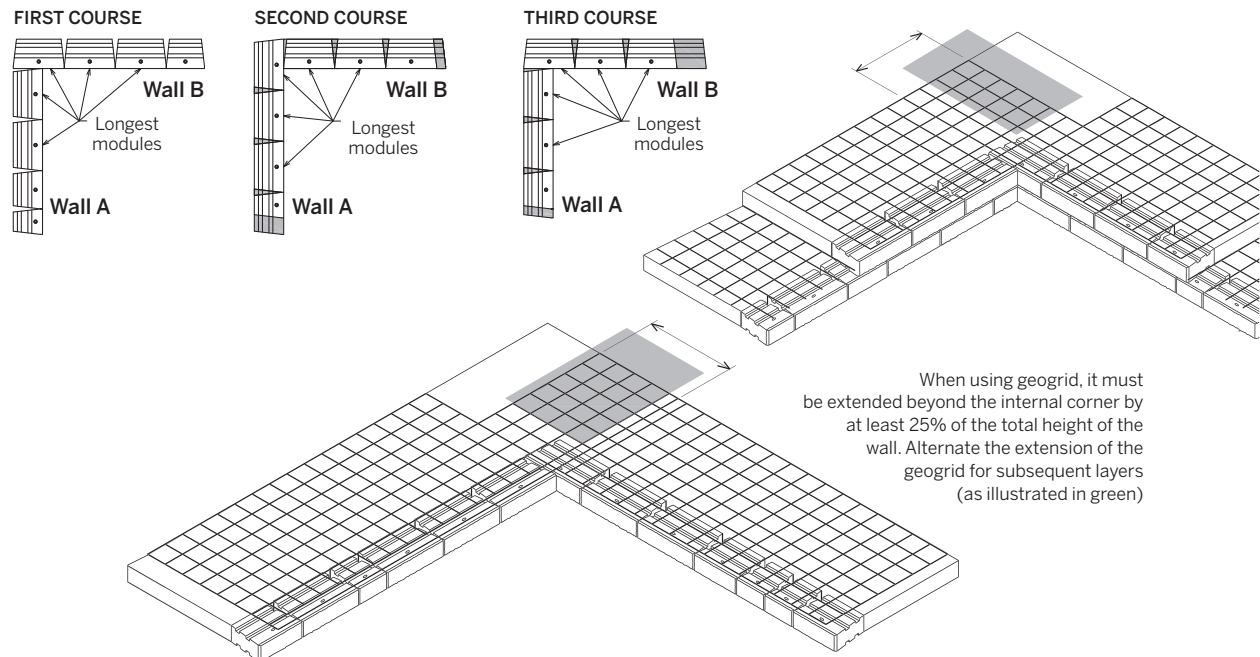

Installation guide

RETAINING WALLS

External corner

For walls with an external corner, start building the wall from the corner and continue from this point in both directions. Each pallet contains units that can be used to make a corner. On-site, these units (except the Suprema blocks) must be split down the side using a hammer and chisel in order to obtain a corner unit. For each subsequent course, alternate the direction of the corner unit and secure the corner unit to the block below using concrete adhesive.

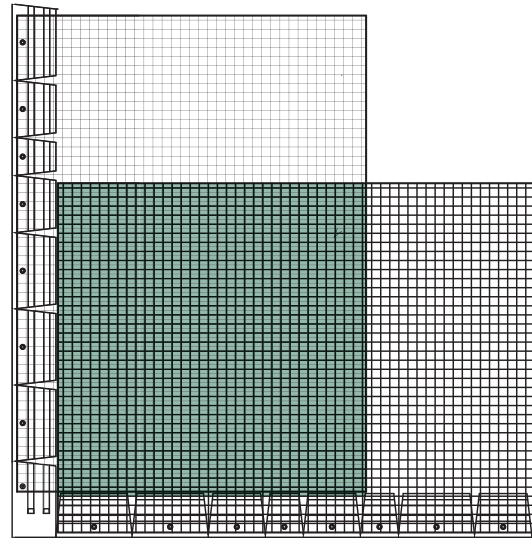
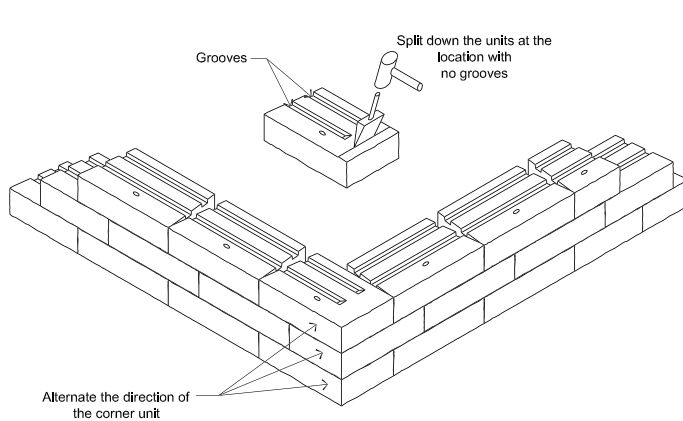

When overlapping two geodrids in the same layer (as illustrated in green) allow at least 3" (75 mm) of backfill in between the overlapping section

Oblique corner

The longer modules should be used to build an oblique external corner. Cut the non-exposed part of the block using a saw. Use a chisel or splitter to give the exposed face of the block a textured look. Alternate the cutting of the blocks for each subsequent course.

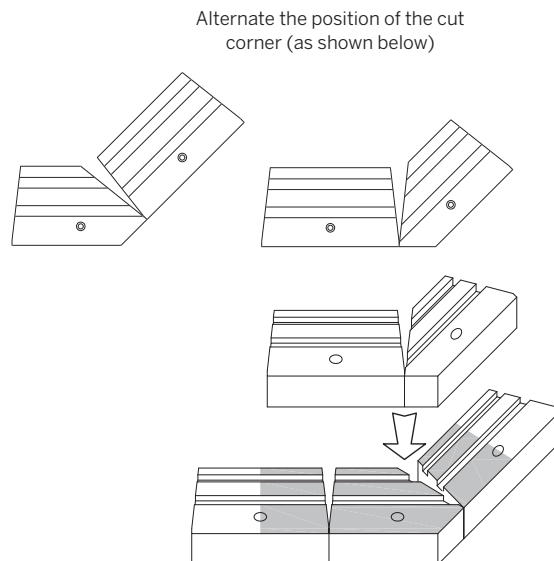
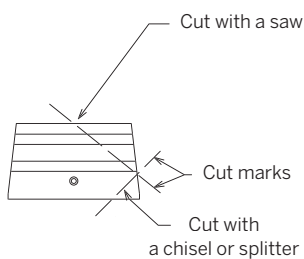

Installation guide

RETAINING WALLS

Internal curve

The Techo-Bloc retaining wall system allows walls to be built with internal and external curves. These curves can be achieved without cutting the blocks. You will need to angle the curves according to the minimum radius specified by Techo-Bloc.

When building a wall with an internal curve, it is recommended to start building the wall at the center of the curve and place blocks alternately to the left and right of the central block. If the wall to be constructed requires a setback (inclined wall), each course should be offset to the back and the curve will then become bigger. The minimum radius is therefore that of the first course.

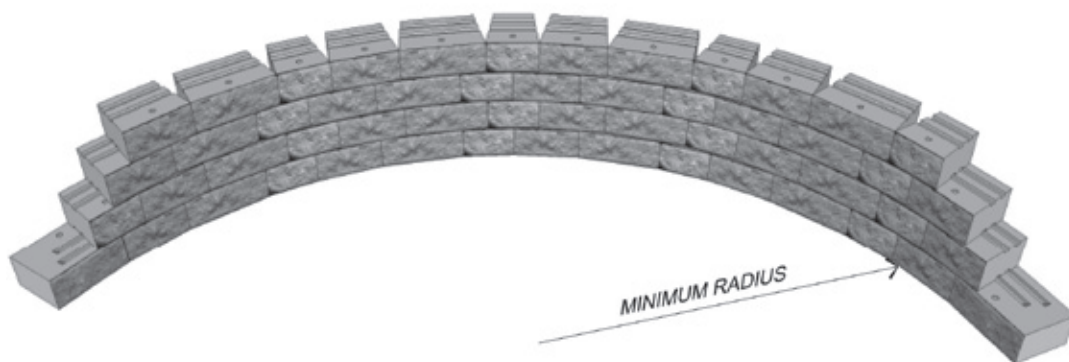

When using geogrid, it must cover 100% of the surface around the curve. To do this, additional layers of geogrid are placed on the next course of blocks to fill voids created from previous course (as illustrated in green).

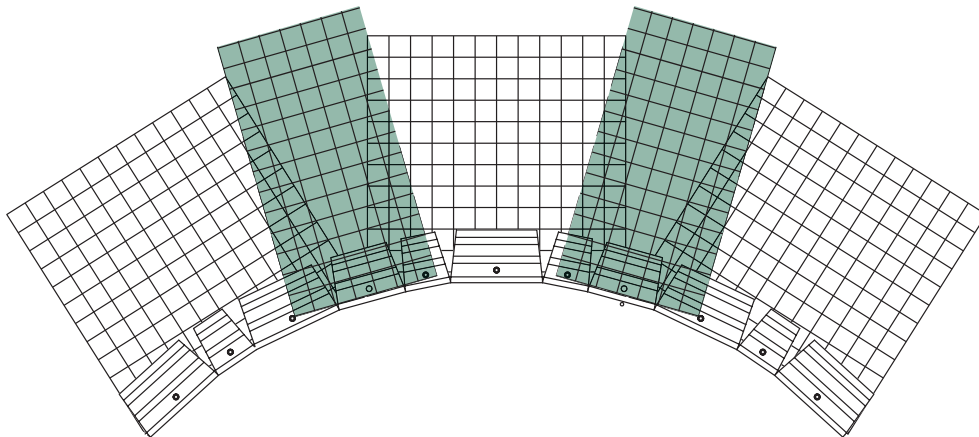

Installation guide

RETAINING WALLS

External curve

When building a wall with an external curve, it is recommended to start building the wall at the center of the curve and place blocks alternately to the left and right of the central block. Unlike internal curves, the external curve gets smaller as courses are added. The minimum radius is therefore that of the last course.

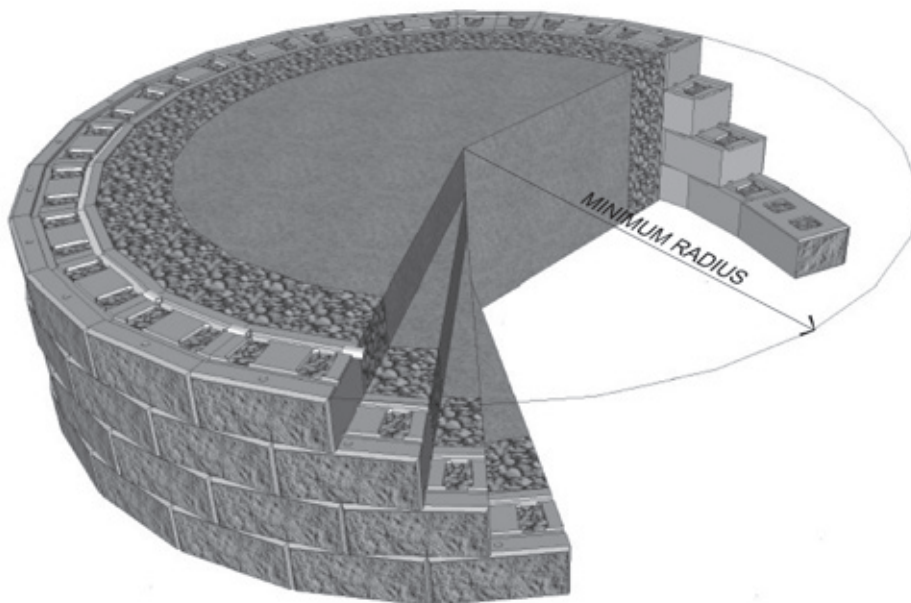

When using geogrid, it must cover 100% of the surface around the curve. To achieve this, additional layers of geogrid are placed on the same course of blocks to fill voids (as illustrated in green). In this case, we recommend at least 3" (75 mm) of backfill in between the overlapping sections.

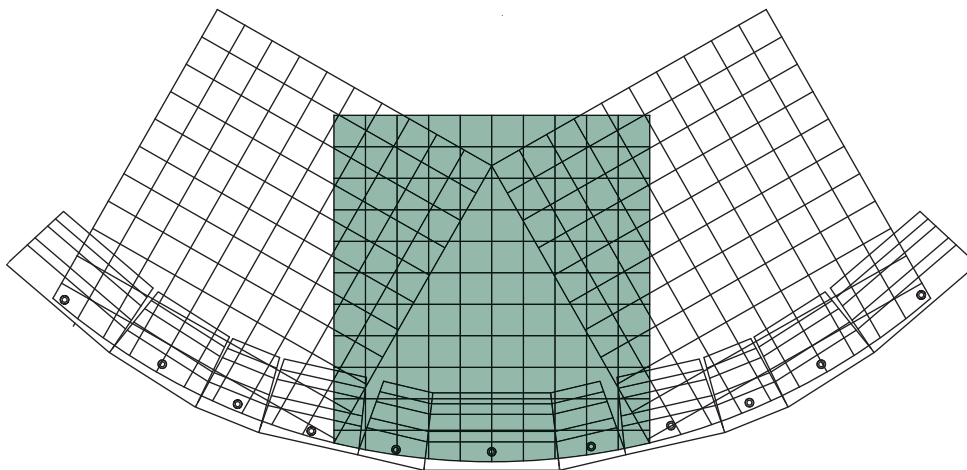

Installation guide

RETAINING WALLS

Fencing

Fencing can be erected behind the blocks. Fence posts must be placed in formwork tubes positioned during construction of the wall and then filled with concrete. The geogrid may be cut to accommodate installation of the tubes. Cut the geogrid in alignment with the center of the formwork tube and perpendicular to the wall, thus creating two geogrid panels. Connect the two geogrid panels at the front and back of the formwork tube and bend the geogrid to fit around the formwork.

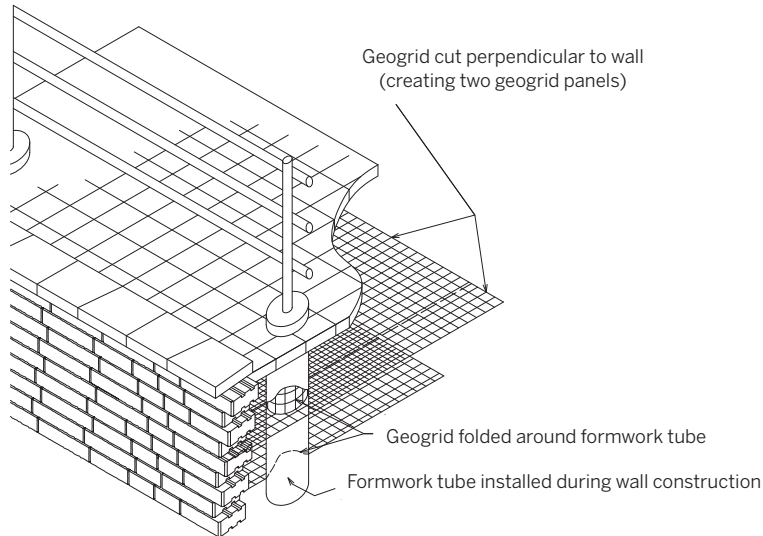

Guard Rail

As with fencing, a guardrail can be incorporated behind the blocks. The guardrail posts must be installed during construction of the wall. The geogrid is cut perpendicular to the wall and in alignment with the center of the post, thus creating two geogrid panels. These two panels are connected at the front and back of the post. The geogrid can be bent to fit around the post.

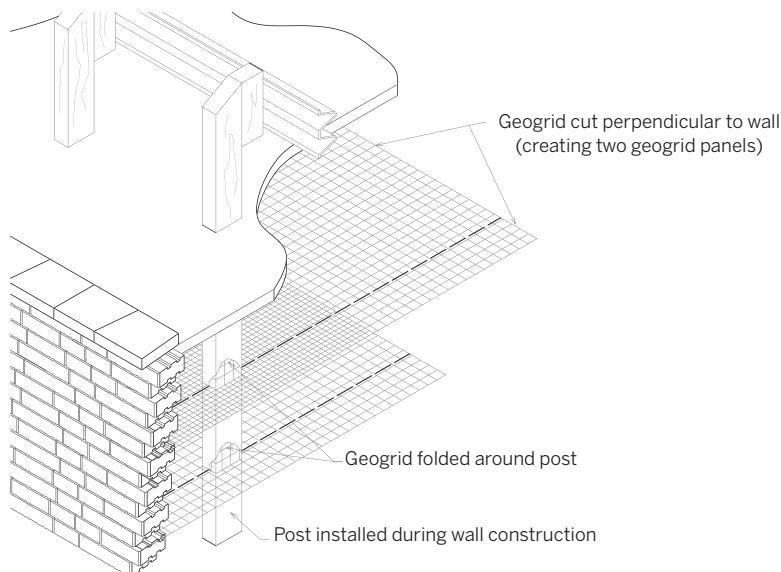

Installation guide

RETAINING WALLS

Tiered wall

Although tiered walls look appealing, it is important to take into account the additional load the upper wall applies on the lower wall. If the distance between the walls is at least twice the height of the lower wall, the walls are generally independent of each other. However, if this distance is less the lower wall must be built to take account of the load of the upper wall and geogrids may be required.

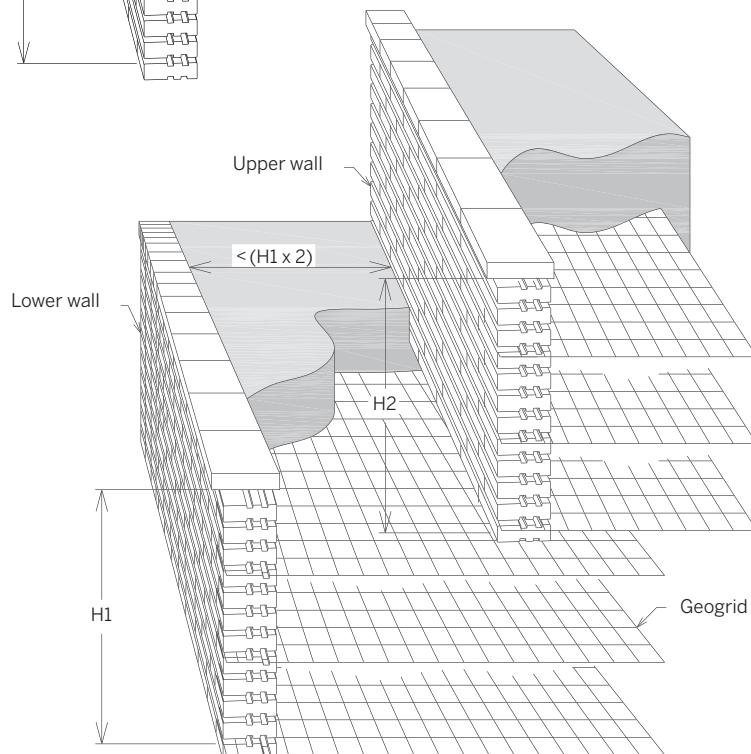
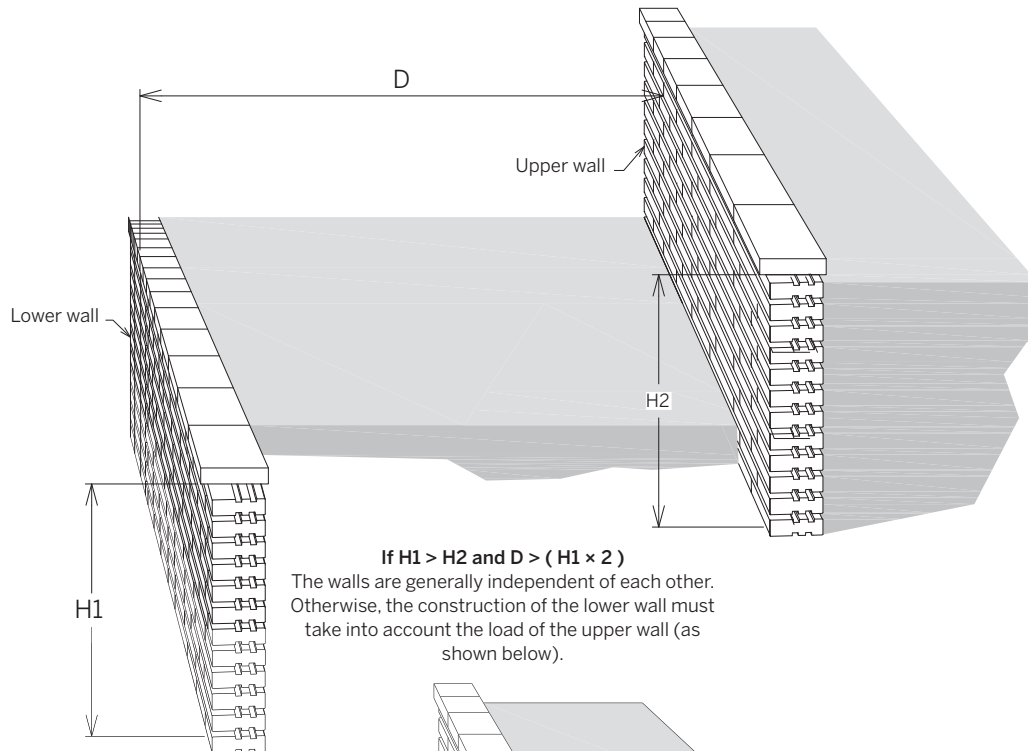

Installation guide

FREESTANDING WALLS

Installation outline

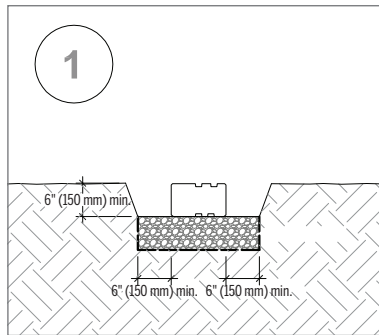

01 EXCAVATION

- Check the location of existing structures and utilities before starting the excavation.
- Dig out a trench. The trench should be 12" wider than the block width (6" (150 mm) at the front and at the back of the wall).
- The trench should be a minimum 18" (450mm) deep. This depth will provide 12" (300mm) for the compacted base and a minimum 6" (150mm) free-standing wall embedment.
- In areas where unstable soils or one particularly affected by freeze-thaw cycles, a thicker compacted base may be necessary.
- The foundation soil should be checked to make sure it is firm, level and capable of supporting the freestanding wall.

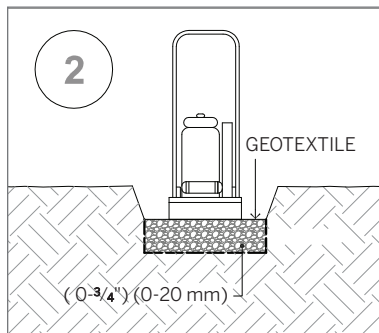

02 FOUNDATION

- Cover the excavated area with a geotextile. Create a leveling pad of compacted aggregate base material. The pad should be composed of 0-3/4" (0-20 mm) crushed stone with a minimum thickness of 12" (300 mm).

NOTE FOR STEPPED FOUNDATION

A wall built on an incline requires stepped foundations. For steep inclines, several steps may be required. Construction should start at the lowest level. Each of the steps must follow a level horizontal path and the vertical distance separating the successive steps must equal the height of a block.

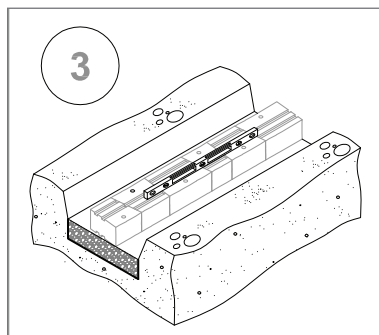

03 BUILDING THE FIRST COURSE

- Using blocks of the same height, place the first course on the compacted leveling pad according to the predetermined layout. Check the alignment and leveling in all directions and make sure that all the blocks are in full contact with the leveling pad and properly supported.
- Place the blocks side by side. There must be no space between adjacent blocks. For alignment of straight walls, use a string line aligned on the connector's slots of applicable units, or back of the block of full solid units.
- For tapered units, alternate front and back faces to obtain straight walls.

Installation guide

FREESTANDING WALLS

Installation outline

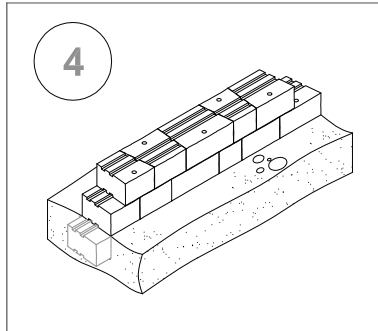

04 SUBSEQUENT COURSES

- A. Clean the top of each block before laying the next course. Depending on the type of block, install the connectors if available on each block.
- B. Stagger joints from one row to the next.
- C. Glue all modules at each row with a concrete adhesive for securing.
- D. All Free-standing walls must be installed in vertical position.
- E. Any cavities in the blocks must be filled with 3/4" (20 mm) clean stone.
- F. Continue building to the desired and permissible height.

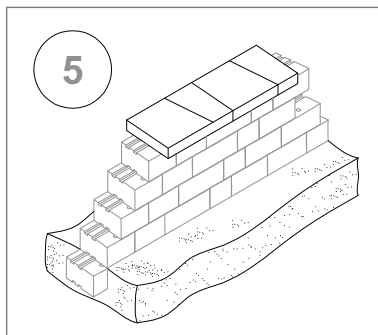

05 FINISHING

- A. Position the cap units (if applicable) or the final course of blocks to complete the wall. The cap units (if applicable) or final course of blocks must be fixed to the subjacent blocks using concrete adhesive and there must be no space between the blocks.

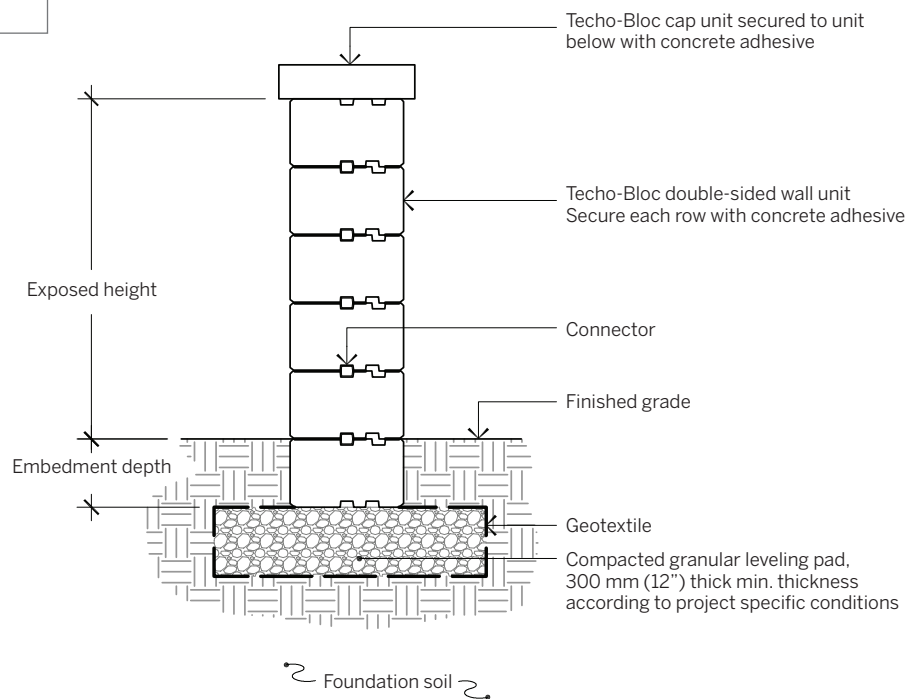

Installation guide

PILLARS

General note

It is important to adequately glue each row with a concrete adhesive in order to obtain a stable pillar.

If you are planning to install a light on top of the pillar, make sure you run the electrical wires prior to installing the blocks.

If you are planning to build a pillar with a planter, make sure to install a geotextile membrane inside the pillar before filling the cavity with planting soil.

Installation outline

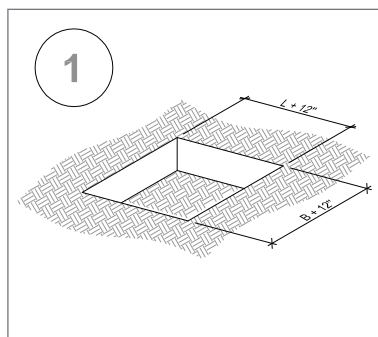

01 EXCAVATION

- Check the location of existing structures and utilities before starting the excavation.
- Excavate an area that is 12" (300 mm) wider than the pillar (6" [150 mm] at each side of the pillar).
- The excavated area should be a minimum 12" (300mm) deep. This depth will provide 6" (150mm) for the compacted base and a minimum 6" (150mm) of embedment.
- In areas where unstable soils or one particularly affected by freeze-thaw cycles, a thicker compacted base may be necessary.
- The foundation soil should be checked to make sure it is firm, level and capable of supporting the pillar.

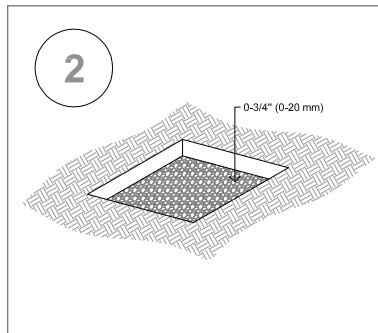

02 FOUNDATION

- Cover the excavated area with a geotextile. Create a leveling pad of compacted granular base material. The pad should be composed of 0-3/4" (0-20 mm) crushed stone with a minimum thickness of 6" (150 mm).

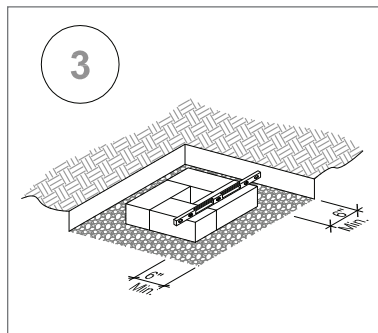

03 BUILDING THE FIRST COURSE

- Using the corresponding pillar or corner units, place the first course on the compacted base according to the predetermined layout. Check the alignment and leveling in all directions and make sure that all the blocks are in full contact with the base and properly supported.

Installation guide

PILLARS

Installation outline

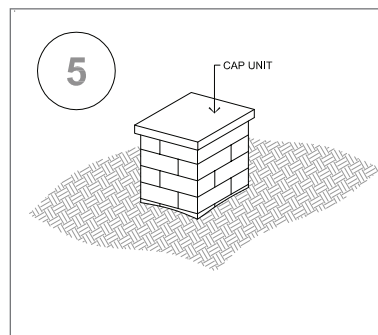
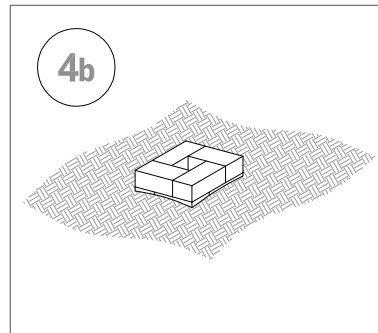
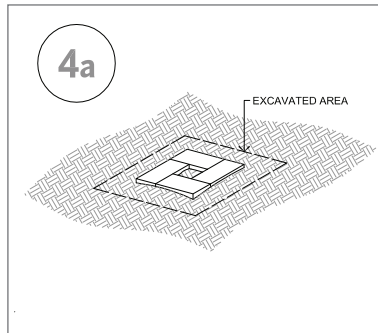

04 SUBSEQUENT COURSES

- Clean the top of each block before laying the next course.
- Stagger joints from one row to the next.
- Glue all modules at each row with a concrete adhesive for securing.
- Backfill the excavated area surrounding the pillar.
- Continue building to desired and permissible height.

05 CROWNING

- Crown the pillar using Techo-Bloc Pillar cap units and securing to blocks underneath with a concrete adhesive.

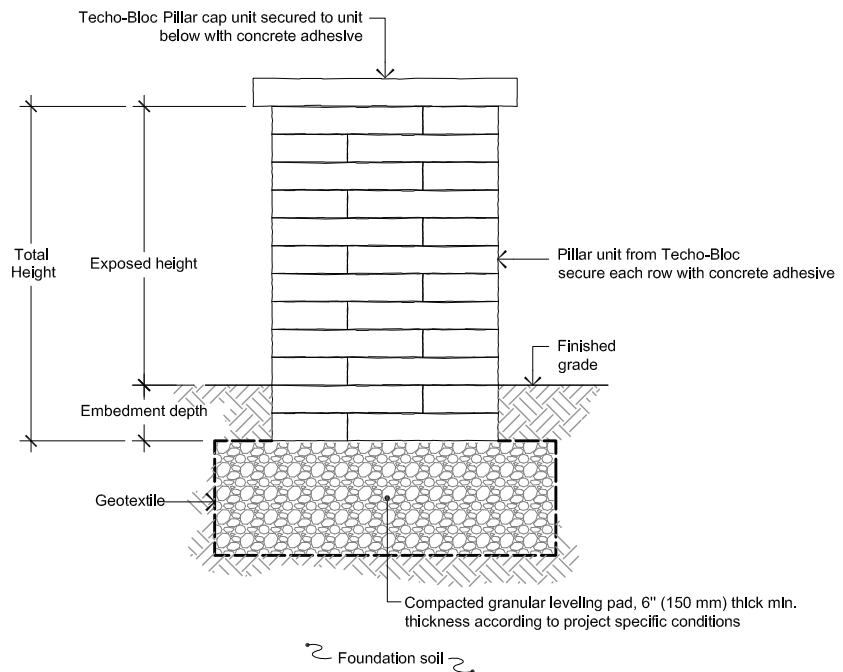

Installation guide

RETAINING WALL DESIGN CHART - BALTIMORE 180 MM

EQUIVALENT TO TWICE THE BALTIMORE 90 mm

The information contained in the design charts is supplied for information purposes only. Techo-Bloc and its predecessors, successors, beneficiaries, employees, associates, administrators and insurers can not under any circumstances be held liable for the incorrect use of information contained in design charts. **This chart should be read in conjunction with the notes on page 103.**

CASE N° 1

Inclined wall (4.4°)

Surcharge: 6 kPa

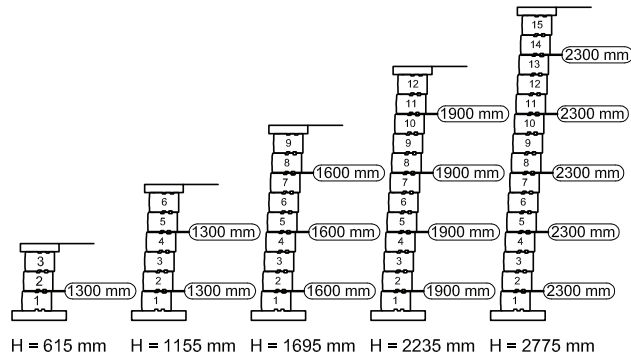
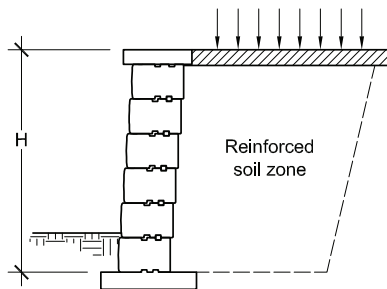

CASE N° 2

Inclined wall (4.4°)

Slope: 1V:3H

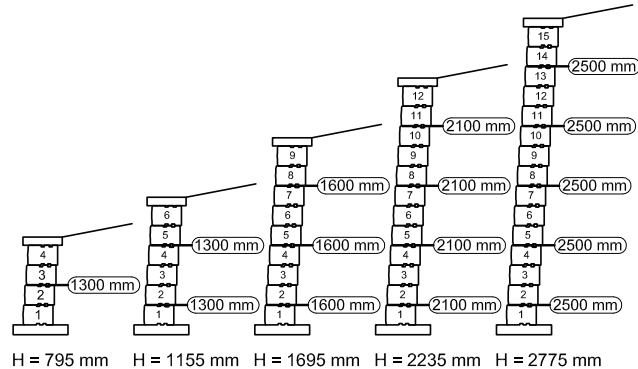
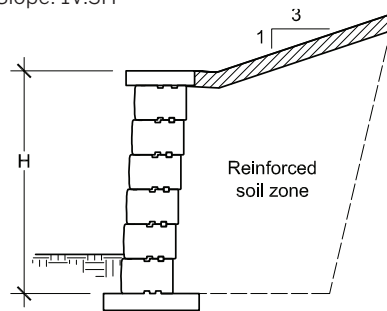

THE DESIGN CHARTS WERE DEVELOPED BASED ON THE FOLLOWING CONDITIONS:

- Geogrid layout determined as per the requirements of the "Design Manual for Segmental Retaining Walls, 3rd Edition" from the National Concrete Masonry Association.
- Geogrid type Miragrid® 3XT from Tencate Mirafi.
- Soil parameters: reinforced soil ($\phi = 36^\circ$, $\gamma = 21 \text{ kN/m}^3$); retained soil ($\phi = 28^\circ$, $\gamma = 20 \text{ kN/m}^3$); foundation soil ($\phi = 28^\circ$, $\gamma = 19 \text{ kN/m}^3$).
- The bearing capacity of the soil, settlement, and global stability must be verified and validated by a qualified geotechnical engineer.
- The seismic analysis was not considered.
- The hydrostatic pressure is not considered. The wall must be provided with an adequate drainage system.
- 6 kPa (125 psf) surcharge (cars and light trucks).
- The design charts do not apply to tiered walls.

For further information, please contact our technical service department.

Email: WALLS@TECHO-BLOC.COM Web site: WWW.TECHO-BLOC.COM

Installation guide

RETAINING WALLS - BALTIMORE 90 MM & 180 MM

These patterns have been developed to capture the look of hand-laid stone. For each pattern, a ratio of quantity is provided, which will guide you in estimating the overall material required for a given project.

RETAINING WALLS - BALTIMORE 90 MM & 180 MM

1-row pattern | Laying patterns

The single row model shows two examples of combinations without the B* module of the Baltimore 180 mm and two examples of combinations without the B module of the Baltimore 180 mm. Each combination is 180 mm long (7 1/16") high. **This model can be used for installing the last row of modules or where other models cannot be used.**

COMBINATIONS WITHOUT THE "B*" MODULE OF THE BALTIMORE 180 mm:

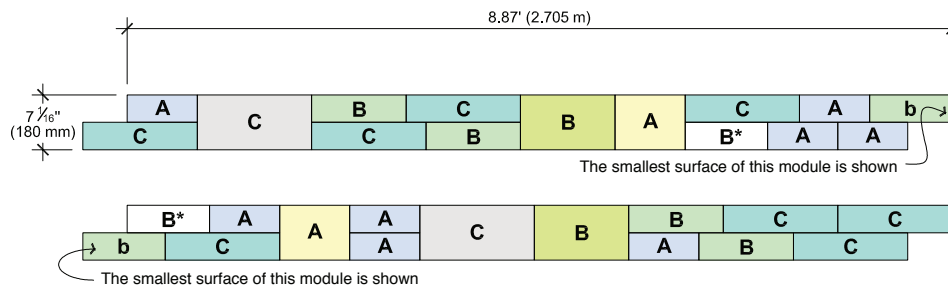

NUMBER OF BLOCKS REQUIRED

BALTIMORE	MODULE			
	A	B	B*	C
67% of the surface - Baltimore 90 mm	4	3	1	4
33% of the surface - Baltimore 180 mm	1	1	0	1

COMBINATIONS WITHOUT THE "B" MODULE OF THE BALTIMORE 180 mm:

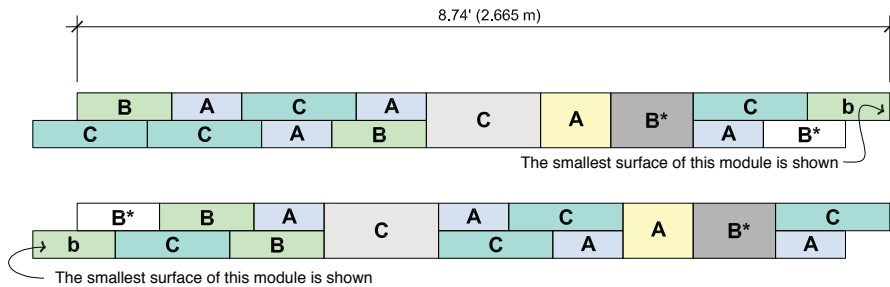

Installation guide

RETAINING WALLS - BALTIMORE 90 MM & 180 MM

NUMBER OF BLOCKS REQUIRED

MODULE

BALTIMORE	A	B	B*	C
67% of the surface - Baltimore 90 mm	4	3	1	4
33% of the surface - Baltimore 180 mm	1	0	1	1

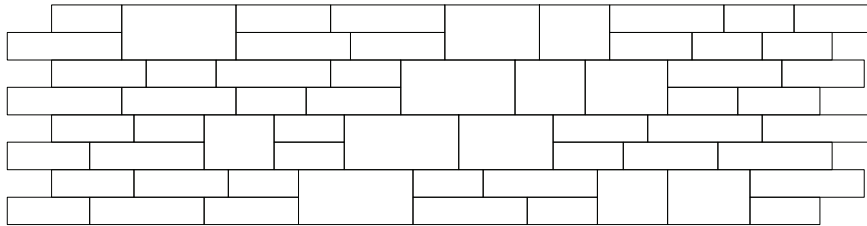

3-row pattern | Laying patterns

The 3-row model is 3.62 m (11.88') long and 540 mm (21 1/4") high. This model allows for a graded area at every 540 mm (21 1/4"), which corresponds to the recommended spacing between the layers of geogrid in a Baltimore wall. **This model is recommended when using the geogrid.**

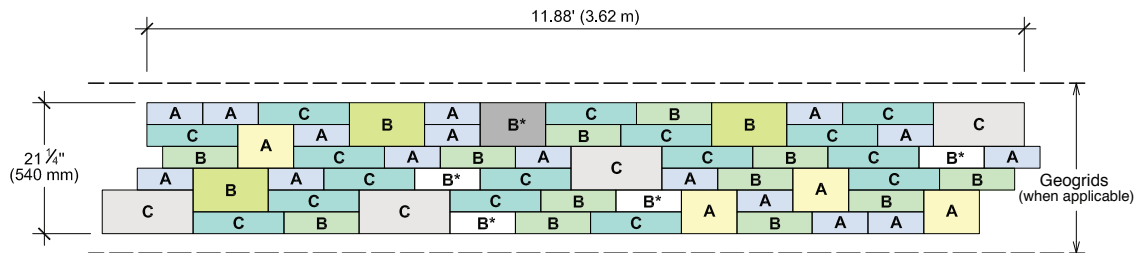

NUMBER OF BLOCKS REQUIRED

MODULE

BALTIMORE	A	B	B*	C
67% of the surface - Baltimore 90 mm	16	12	4	16
33% of the surface - Baltimore 180 mm	4	3	1	4

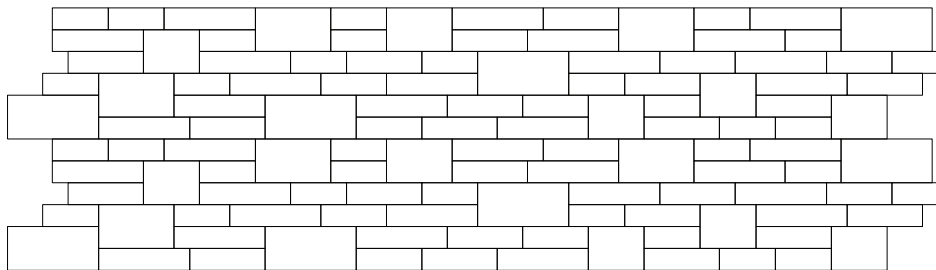

Installation guide

RETAINING WALLS - BALTIMORE 90 MM & 180 MM

4-row pattern | Laying patterns

The 4-row model shows two examples of combination. This combination is 2.705 m (8,87') long and 720 mm (28 3/8") high. **This model should only be used where geogrid is not required.**

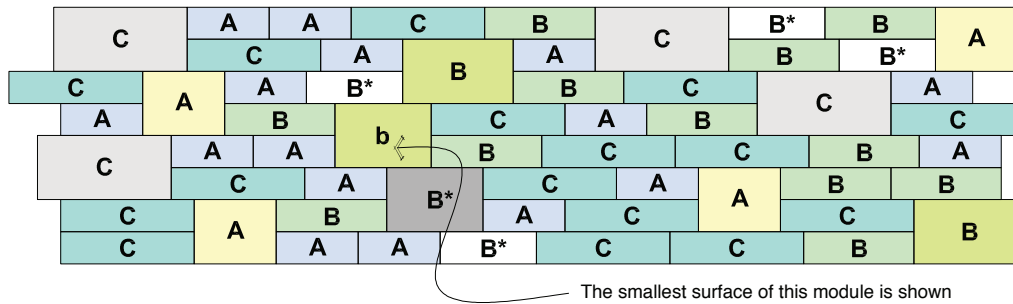
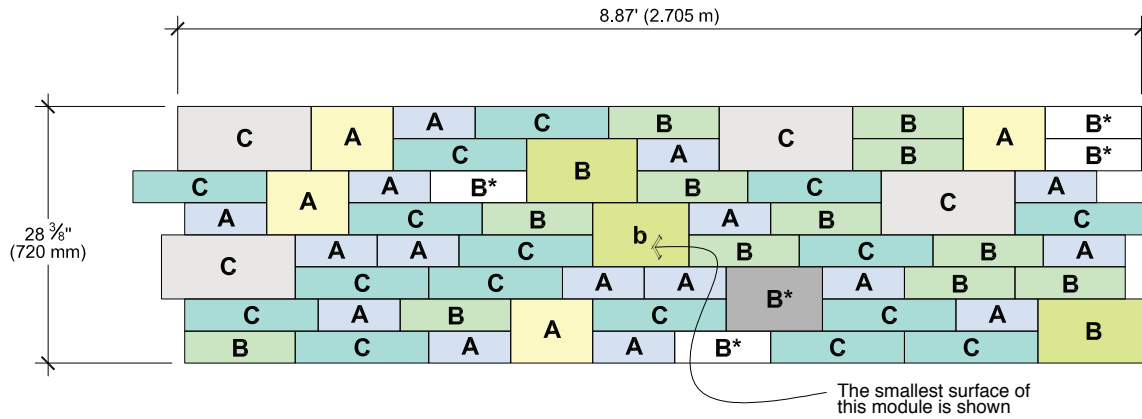

NUMBER OF BLOCKS REQUIRED

MODULE

BALTIMORE	A	B	B*	C
67% of the surface - Baltimore 90 mm	16	12	4	16
33% of the surface - Baltimore 180 mm	4	3	1	4

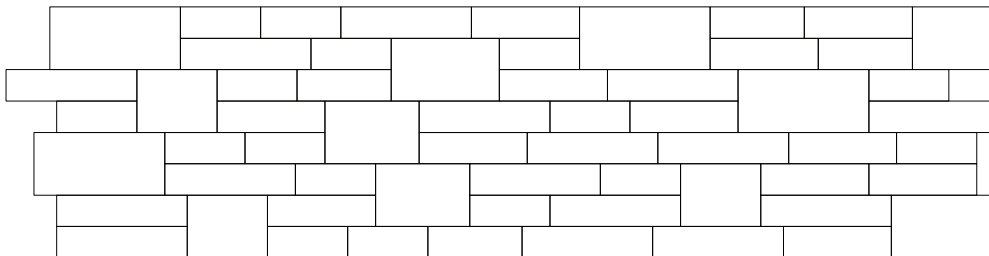

Installation guide

FREESTANDING WALLS - BALTIMORE 90 MM & 180 MM

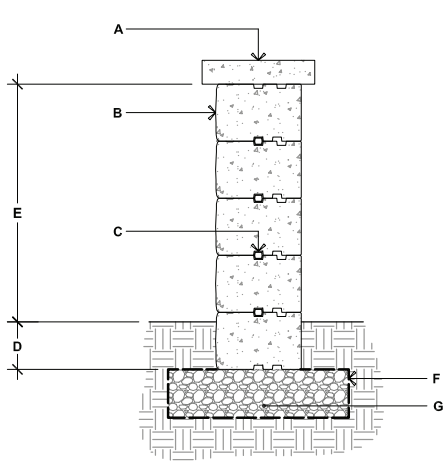

BALTIMORE 90 mm & 180 mm

- A.** TECO-BLOC CAP UNIT, SECURED TO UNIT BELOW WITH CONCRETE ADHESIVE
- B.** BALTIMORE 90 mm AND 180 mm DOUBLE-SIDED WALL UNITS SECURE EACH ROW WITH CONCRETE ADHESIVE
- C.** CONNECTOR
- D.** EMBEDMENT DEPTH, 6" (150 mm) MIN.
- E.** 29 ⁷/₁₆" (750 mm) MAX.
- F.** GEOTEXTILE
- G.** COMPACTED GRANULAR LEVELING PAD, 12" (300 mm) THICK MIN. THICKNESS ACCORDING TO PROJECT SPECIFIC CONDITIONS

90° CORNER OF A DOUBLE-SIDED WALL

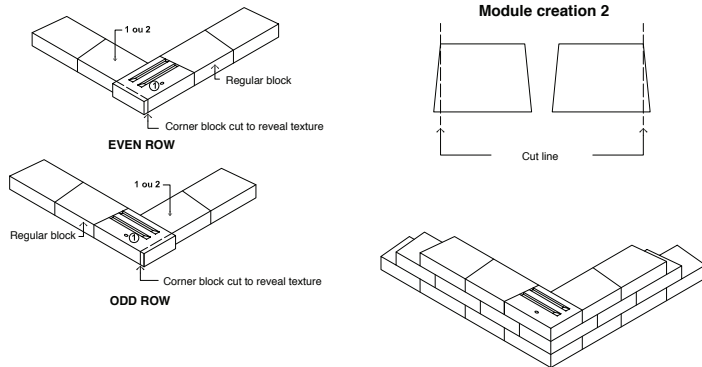

1. Alternate odd and even rows.
2. Stagger joints from one row to the next.
3. Glue all modules at each row with a concrete adhesive.
4. Cavities, grooves and connectors are not illustrated to avoid overloading the image.
5. It is possible to alternate the blocks (A, B or C) in the same row to create different patterns. However, a corner block must always be present at the end of a row and must be alternated for each subsequent row.

DOUBLE-SIDED WALL - END OF A STRAIGHT WALL

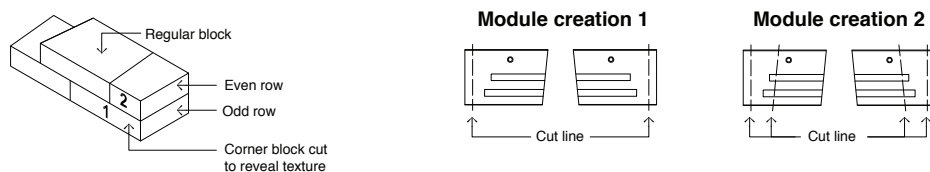

* It is possible to alternate the blocks (A, B or C) in the same row to create different patterns. However, a corner block must always be present at the end of a row and must be alternated for each subsequent row.

Installation guide

DOUBLE-SIDED WALL RADIUS - BALTIMORE 90 MM & 180 MM

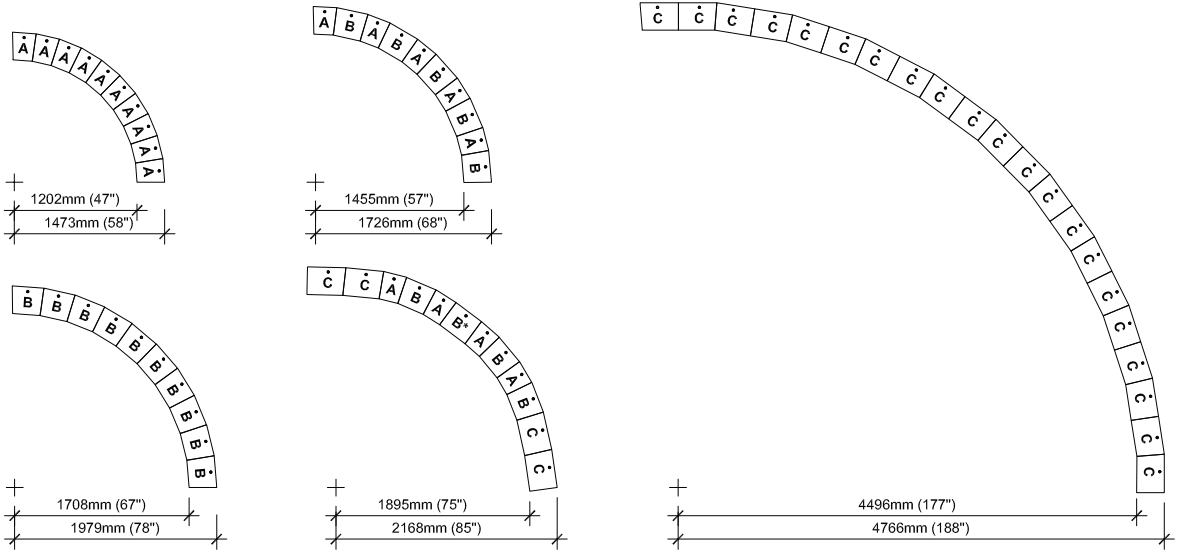

It is the user's responsibility to verify for the quantity of materials required.

STEPS

BALTIMORE 90 mm

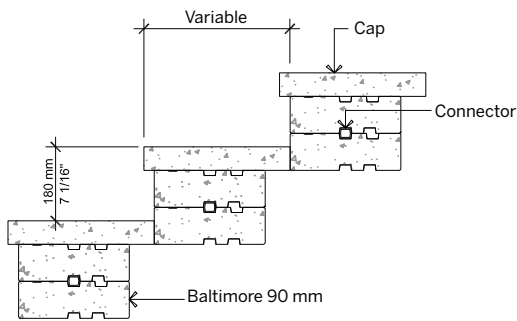

BALTIMORE 180 mm

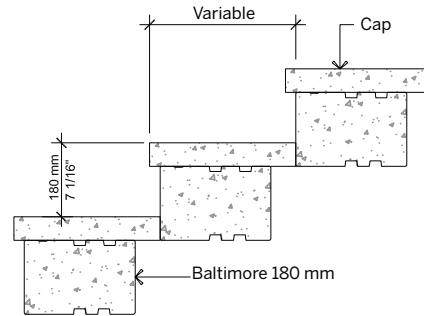

For all possible combinations of walls and caps, please refer to the correspondence table on page 99.

Installation guide

FREESTANDING WALLS- BOREALIS

BOREALIS

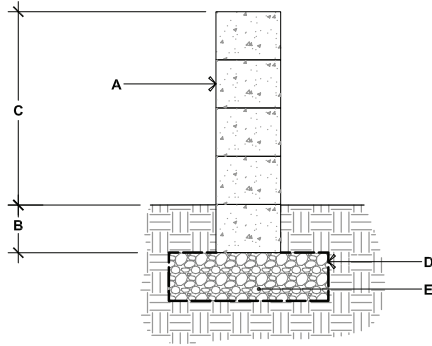

- A.** BOREALIS DOUBLE-SIDED WALL UNITS
SECURE EACH ROW WITH CONCRETE ADHESIVE
- B.** EMBEDMENT DEPTH, 6" (150 mm) MIN.
- C.** 24" (612 mm) MAX.
- D.** GEOTEXTILE
- E.** COMPACTED GRANULAR LEVELING PAD, 12" (300 mm) THICK MIN. THICKNESS
ACCORDING TO PROJECT SPECIFIC CONDITIONS

90° CORNER OF A DOUBLE-SIDED WALL

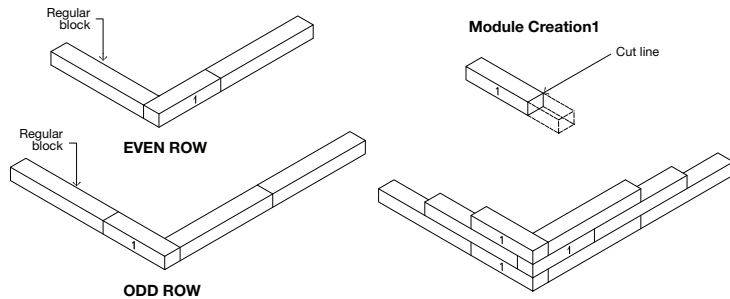

1. Alternate odd and even rows.
2. Stagger joints from one row to the next.
3. Glue all modules at each row with a concrete adhesive.

DOUBLE-SIDED WALL - END OF A STRAIGHT WALL

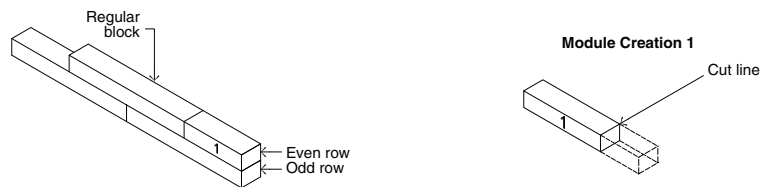

Installation guide

RETAINING WALL DESIGN CHART - BRANDON 180 MM

EQUIVALENT TO TWICE THE BRANDON 90 mm

The information contained in the design charts is supplied for information purposes only. Techo-Bloc and its predecessors, successors, beneficiaries, employees, associates, administrators and insurers can not under any circumstances be held liable for the incorrect use of information contained in design charts. **This chart should be read in conjunction with the notes on page 103.**

CASE N° 1

Inclined wall (4.4°)
Surcharge: 6 kPa

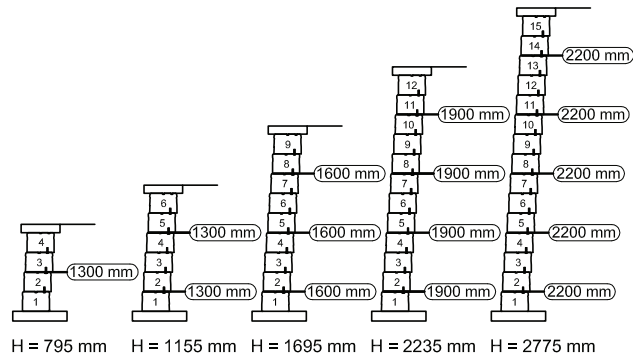
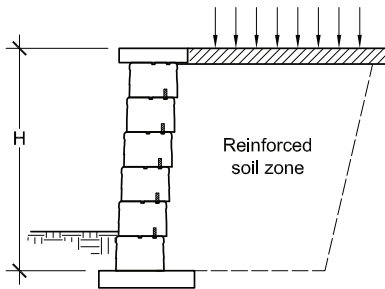

CASE N° 2

Inclined wall (4.4°)
Slope: 1V:3H

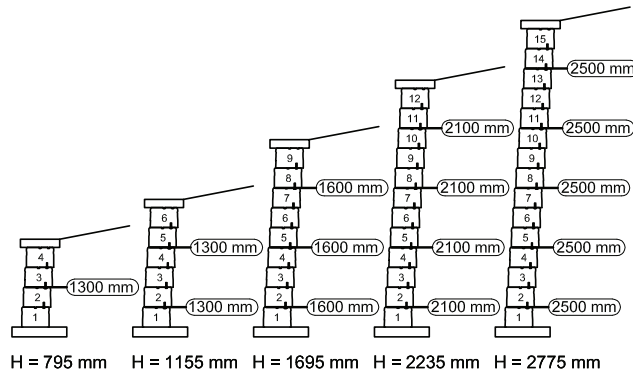
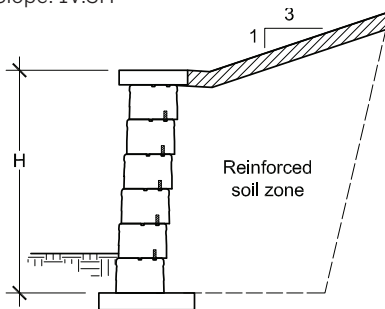

THE DESIGN CHARTS WERE DEVELOPED BASED ON THE FOLLOWING CONDITIONS:

- Geogrid layout determined as per the requirements of the "Design Manual for Segmental Retaining Walls, 3rd Edition" from the National Concrete Masonry Association.
- Geogrid type Miragrid® 3XT from Tencate Mirafi.
- Soil parameters: reinforced soil ($\phi = 36^\circ$, $\gamma = 21 \text{ kN/m}^3$); retained soil ($\phi = 28^\circ$, $\gamma = 20 \text{ kN/m}^3$); foundation soil ($\phi = 28^\circ$, $\gamma = 19 \text{ kN/m}^3$).
- The bearing capacity of the soil, settlement, and global stability must be verified and validated by a qualified geotechnical engineer.
- The seismic analysis was not considered.
- The hydrostatic pressure is not considered. The wall must be provided with an adequate drainage system.
- 6 kPa (125 psf) surcharge (cars and light trucks).
- The design charts do not apply to tiered walls.

For further information, please contact our technical service department.

Email: WALLS@TECHO-BLOC.COM Web site: WWW.TECHO-BLOC.COM

Installation guide

RETAINING WALLS - BRANDON 90 & 180 mm

These patterns have been developed to capture the look of hand-laid stone. For each pattern, a ratio of quantity is provided, which will guide you in estimating the overall material required for a given project.

1-row pattern | Laying patterns

The 1-row pattern provides three different combinations. Each combination is 10.38' (3.165 m) long and 7 1/16" (180 mm) high. **This pattern can be used for installing the last row of modules or where other patterns cannot be used.**

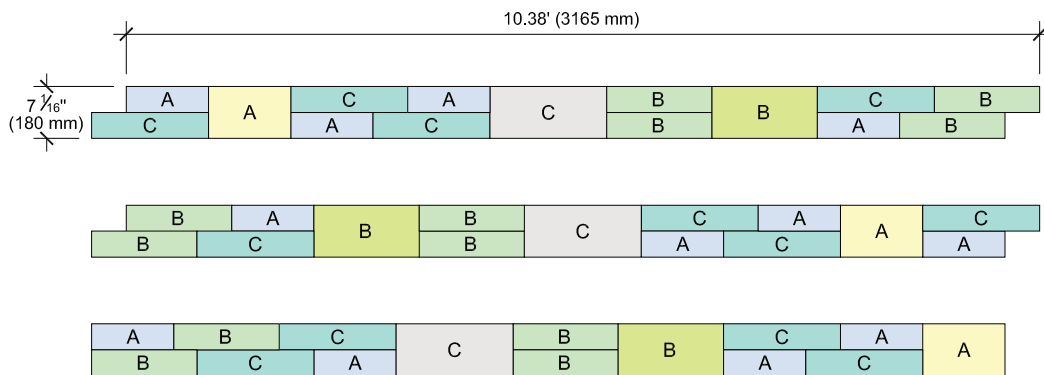

NUMBER OF BLOCKS REQUIRED

BRANDON

67% of the surface - Brandon 90 mm

33% of the surface - Brandon 180 mm

MODULE

	A	B	C
67% of the surface - Brandon 90 mm	4	4	4
33% of the surface - Brandon 180 mm	1	1	1

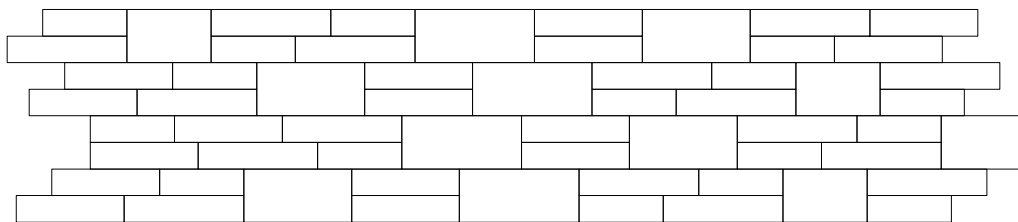

Installation guide

RETAINING WALLS - BRANDON 90 & 180 mm

3-row pattern | Laying patterns

The 3-row pattern is 10.38' (3.165 m) long and 21 1/4" (540 mm) high. This pattern allows a continuous leveled surface every 21 1/4" (540 mm), which corresponds to the recommended maximum spacing between the layers of geogrid in a Brandon wall. **This pattern is recommended when using the geogrid.**

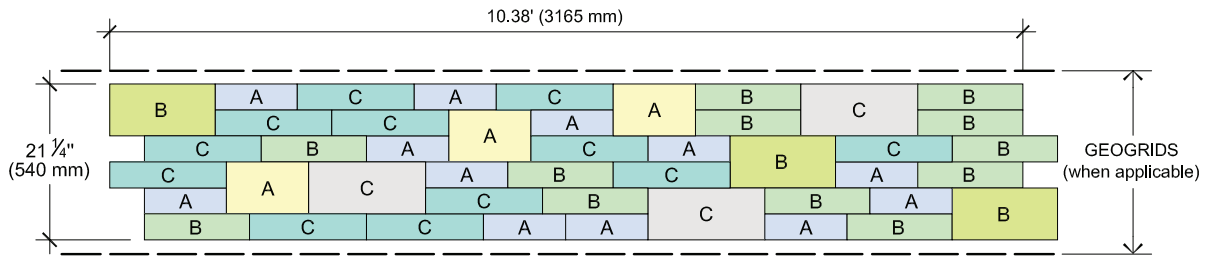

NUMBER OF BLOCKS REQUIRED

MODULE

BRANDON	A	B	C
67% of the surface - Brandon 90 mm	12	12	12
33% of the surface - Brandon 180 mm	3	3	3

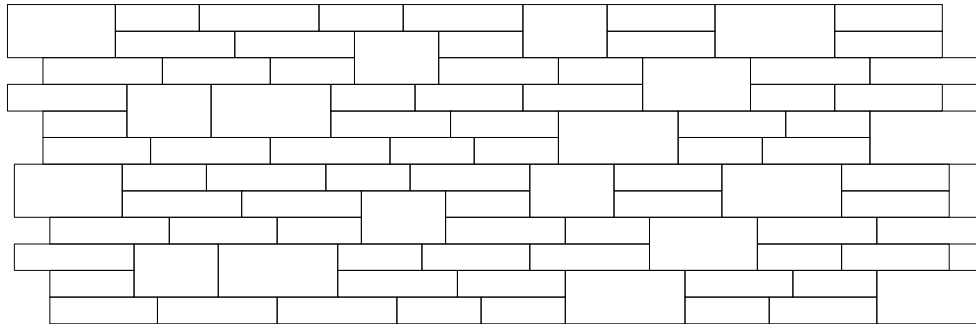

Installation guide

RETAINING WALLS - BRANDON 90 & 180 mm

4-row pattern | Laying patterns

The 4-row pattern is 10.38' (3.165 m) long and 28 3/8" (720 mm) high. **This pattern should be used only where the geogrid is not required.**

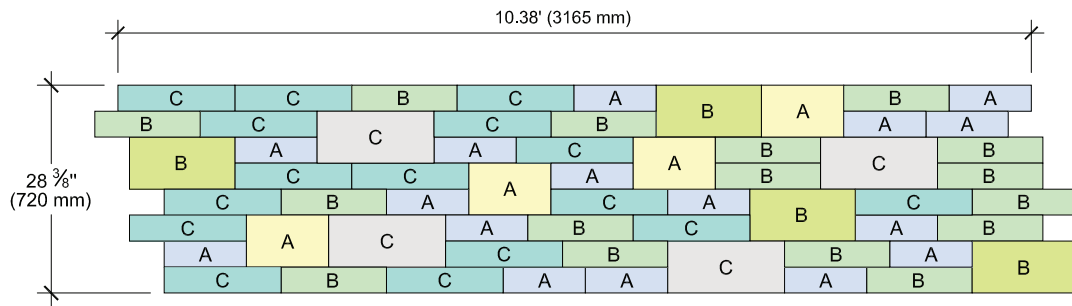

NUMBER OF BLOCKS REQUIRED

MODULE

BRANDON

67% of the surface - Brandon 90 mm

33% of the surface - Brandon 180 mm

	A	B	C
67% of the surface - Brandon 90 mm	16	16	16
33% of the surface - Brandon 180 mm	4	4	4

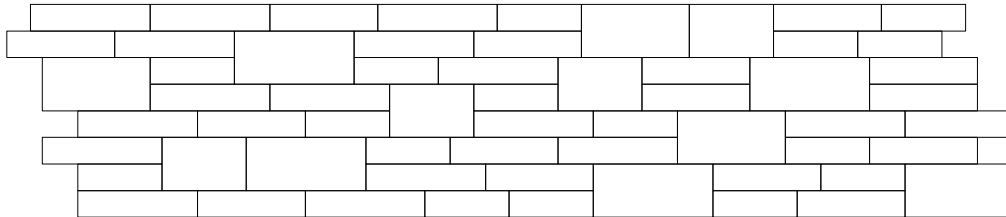

Installation guide

FREESTANDING WALLS - BRANDON 90 & 180 mm

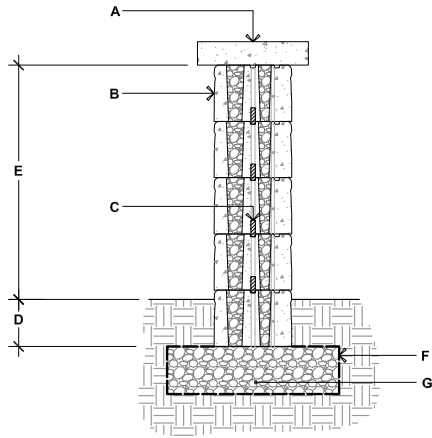

BRANDON 90 mm & 180 mm

- A. TECO-BLOC CAP UNIT SECURED TO UNIT BELOW WITH CONCRETE ADHESIVE
- B. BRANDON 90 mm AND 180 mm DOUBLE-SIDED WALL UNITS SECURE EACH ROW WITH CONCRETE ADHESIVE
- C. CONNECTOR
- D. EMBEDMENT DEPTH, 6" (150 mm) MIN.
- E. 29 ⁷/₁₆" (750 mm) MAX.
- F. GEOTEXTILE
- G. COMPACTED GRANULAR LEVELING PAD, 12" (300 mm) THICK MIN. THICKNESS ACCORDING TO PROJECT SPECIFIC CONDITIONS

90° CORNER OF A DOUBLE-SIDED WALL

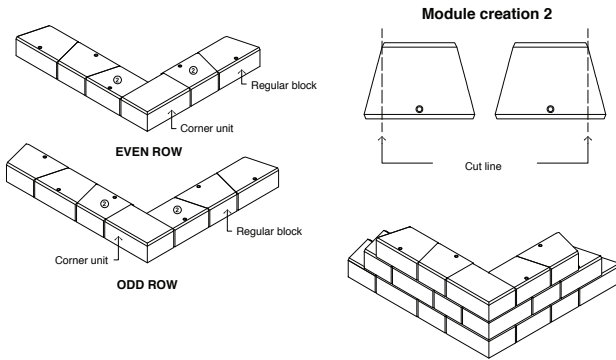

1. Alternate odd and even rows.
2. Stagger joints from one row to the next.
3. Glue all modules at each row with a concrete adhesive.
4. Cavities, grooves and connectors are not illustrated to avoid overloading the image.

DOUBLE-SIDED WALL - END OF A STRAIGHT WALL

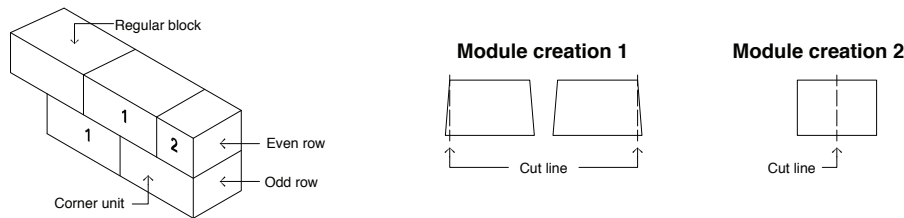

GENERAL NOTES

1. Alternate odd and even rows.
2. Stagger joints from one row to the next.
3. Glue all modules at each row with a concrete adhesive.
4. Cavities, grooves and connectors are not illustrated to avoid overloading the image.

Installation guide

PILLARS - BRANDON 90 & 180 mm

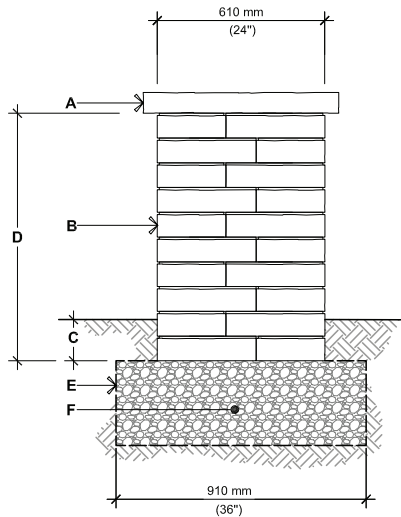

○ BRANDON 90 mm

- A.** PILLAR CAP UNIT, SECURE TO UNITS BELOW WITH A CONCRETE ADHESIVE
- B.** BRANDON 90 mm PILLAR UNIT SECURE EACH ROW WITH CONCRETE ADHESIVE
- C.** EMBEDMENT DEPTH: 150 mm (6") MIN.
- D.** 900 mm (35⁷/₁₆"), HEIGHT PER PALLET 1 080 mm (42¹/₂"), MAXIMUM HEIGHT
- E.** GEOTEXTILE
- F.** COMPACTED GRANULAR BASE 150 mm (6") THICK MIN. THICKNESS ACCORDING TO PROJECT SPECIFIC CONDITIONS

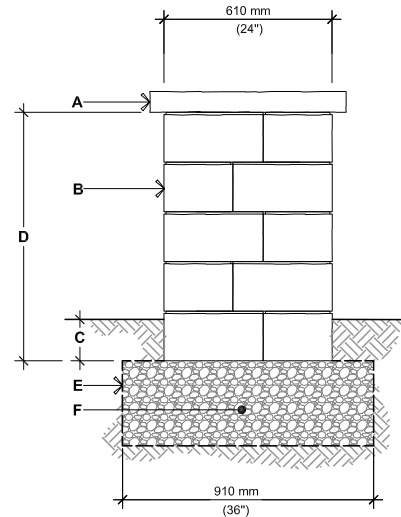

○ BRANDON 180 mm

- A.** PILLAR CAP UNIT, SECURE TO UNITS BELOW WITH A CONCRETE ADHESIVE
- B.** BRANDON 180 mm PILLAR UNIT SECURE EACH ROW WITH CONCRETE ADHESIVE
- C.** EMBEDMENT DEPTH: 150 mm (6") MIN.
- D.** 900 mm (35⁷/₁₆"), HEIGHT PER PALLET 1 080 mm (42¹/₂"), MAXIMUM HEIGHT
- E.** GEOTEXTILE
- F.** COMPACTED GRANULAR BASE 150 mm (6") THICK MIN. THICKNESS ACCORDING TO PROJECT SPECIFIC CONDITIONS

For all possible combinations of pillars and caps, please refer to the correspondence table on page 99.

Installation guide

PILLARS - BRANDON 90 & 180 mm

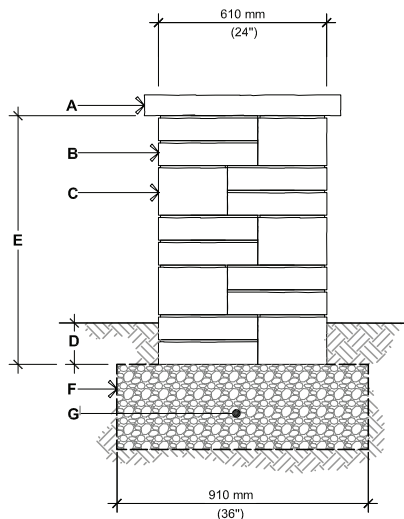

BRANDON 90 mm & 180 mm
OPTION A

- A.** PILLAR CAP UNIT, SECURE TO UNITS BELOW WITH A CONCRETE ADHESIVE
- B.** BRANDON 90 mm PILLAR UNIT SECURE EACH ROW WITH CONCRETE ADHESIVE
- C.** BRANDON 180 mm PILLAR UNIT SECURE EACH ROW WITH CONCRETE ADHESIVE
- D.** EMBEDMENT DEPTH: 150 mm (6") MIN.
- E.** 900 mm (35 ⁷/₁₆"), 1 080 mm (42 ¹/₂"), MAXIMUM HEIGHT
- F.** GEOTEXTILE
- G.** COMPACTED GRANULAR BASE 150 mm (6") THICK MIN. THICKNESS ACCORDING TO PROJECT SPECIFIC CONDITIONS

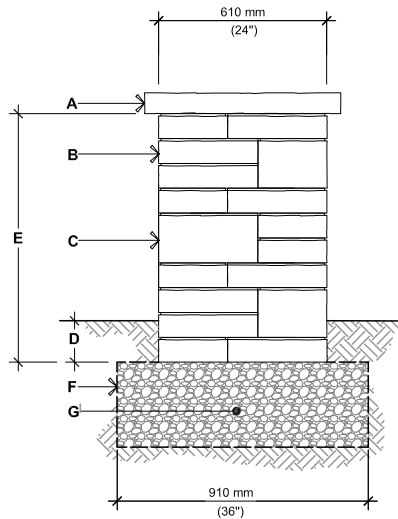

BRANDON 90 mm & 180 mm
OPTION B

- A.** PILLAR CAP UNIT, SECURE TO UNITS BELOW WITH A CONCRETE ADHESIVE
- B.** BRANDON 90 mm PILLAR UNIT SECURE EACH ROW WITH CONCRETE ADHESIVE
- C.** BRANDON 180 mm PILLAR UNIT SECURE EACH ROW WITH CONCRETE ADHESIVE
- D.** EMBEDMENT DEPTH: 150 mm (6") MIN.
- E.** 900 mm (35 ⁷/₁₆"), 1 080 mm (42 ¹/₂"), MAXIMUM HEIGHT
- F.** GEOTEXTILE
- G.** COMPACTED GRANULAR BASE 150 mm (6") THICK MIN. THICKNESS ACCORDING TO PROJECT SPECIFIC CONDITIONS

For all possible combinations of pillars and caps, please refer to the correspondence table on page 99.

Installation guide

GRILL ISLAND - BRANDON 90 & 180 mm

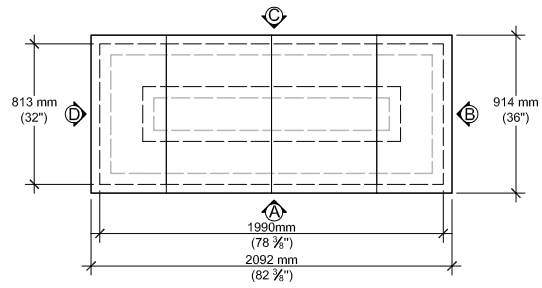

TOP VIEW

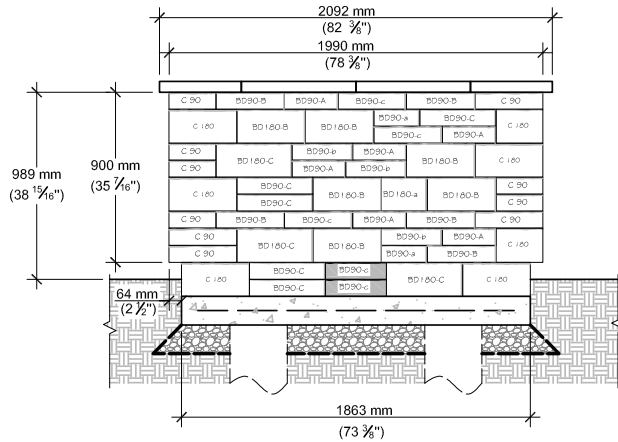

ELEVATION A

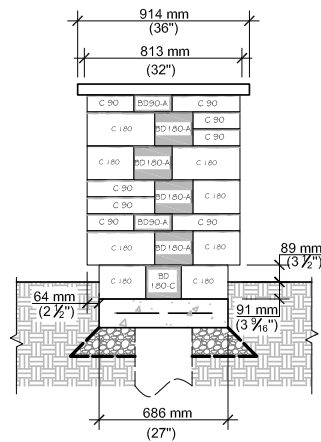

ELEVATION B

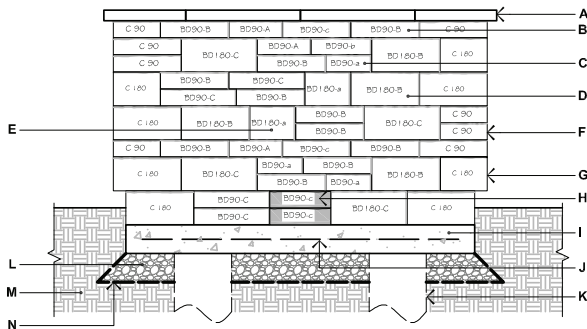

ELEVATION C

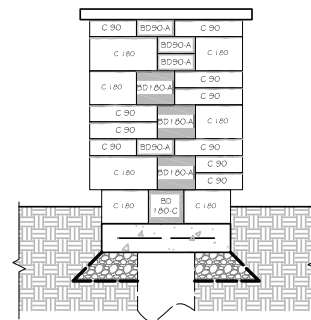

ELEVATION D

- A. YORK COUNTER TOP 24" × 36" × 2 1/4"
- B. BRANDON 90 MM UNIT (A, B OR C) – LONG FACE EXPOSED (SHOWN WITH UPPERCASE LETTER)
- C. BRANDON 90 MM UNIT (A, B OR C) – SHORT FACE EXPOSED (SHOWN WITH LOWERCASE LETTER)
- D. BRANDON 180 MM UNIT (A, B OR C) – LONG FACE EXPOSED (SHOWN WITH UPPERCASE LETTER)
- E. BRANDON 180 MM UNIT (A, B OR C) – SHORT FACE EXPOSED (SHOWN WITH LOWERCASE LETTER)
- F. BRANDON 90 MM PILLAR UNIT
- G. BRANDON 180 MM PILLAR UNIT
- H. BRANDON UNIT CUT ON FIELD
- I. CAST IN PLACE CONCRETE SLAB 4350 PSI (30 MPA), 5" (125 MM) THICK
- J. 4X4-4/4 (102X102-MW25.8XMW25.8) WELDED WIRE MESH AND/OR REBAR AS PER SITE CONDITIONS
- K. 12" (300 MM) DIA. CONCRETE PILLAR, AS PER LOCAL CODE
- L. 3/4" (20 MM) CLEAN STONE 6" (150 MM) THICK MIN. AS PER SITE CONDITIONS
- M. NATURAL SOIL OR COMPACTED BACKFILL
- N. GEOTEXTILE

QUANTITY OF MATERIALS REQUIRED

- York Counter top 24" × 36" × 2 1/4": **4**
- Brandon 90 mm unit: **20 A, 20 B, 18 C**
- Brandon 180 mm unit: **10 A, 10 B, 9 C**
- Brandon 90 mm Pillar unit: **18**
- Brandon 180 mm Pillar unit: **15**

NOTE: Appliances and utilities may vary for each project and are not shown on this drawing. This drawing is shown for inspiration only and surplus or shortage of materials may result. It is the user's responsibility to verify for the quantity of materials required. Secure the blocks using a heat resistant concrete adhesive. The installer must ensure that the installation and use of the grill island comply with local regulations and code requirements. Concrete pillars extending to frost line may be required as per local code. Check your local building code before installing.

Installation guide

RETAINING WALL DESIGN CHART - ESCALA 3.5"

The information contained in the design charts is supplied for information purposes only. Techo-Bloc and its predecessors, successors, beneficiaries, employees, associates, administrators and insurers can not under any circumstances be held liable for the incorrect use of information contained in design charts. **This chart should be read in conjunction with the notes on page 103.**

CASE N° 1

Inclined wall (4°)
Surcharge: 6 kPa

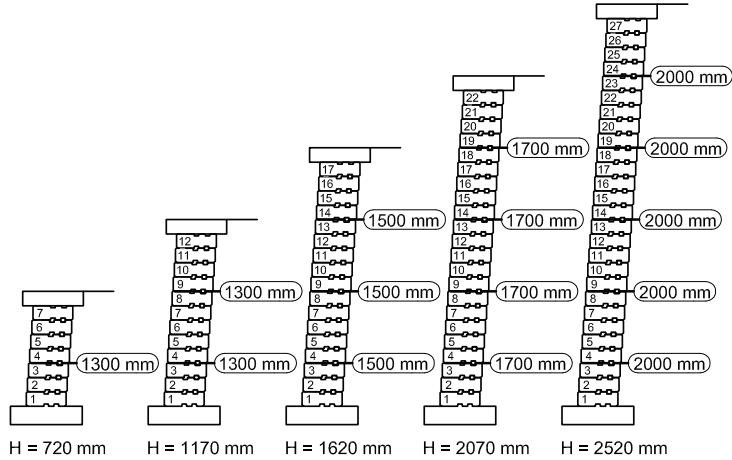
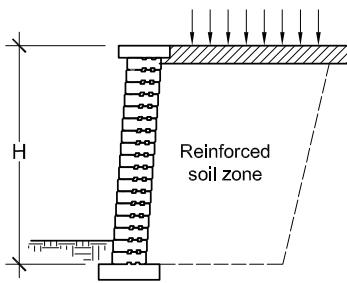

CASE N° 2

Inclined wall (4°)
Slope: 1V:3H

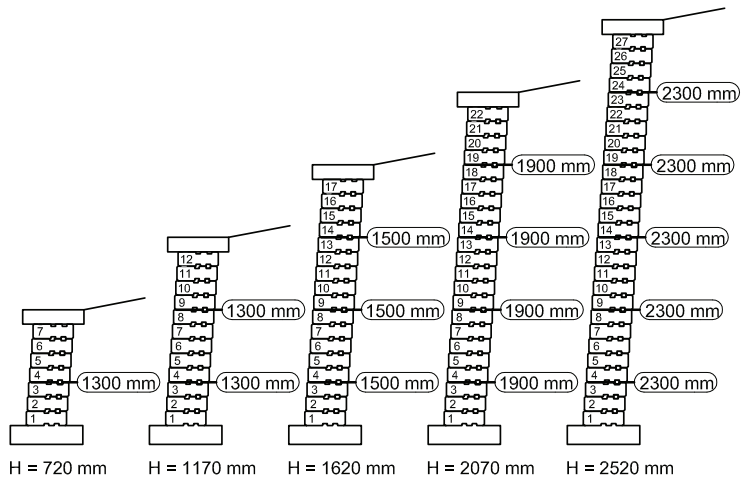
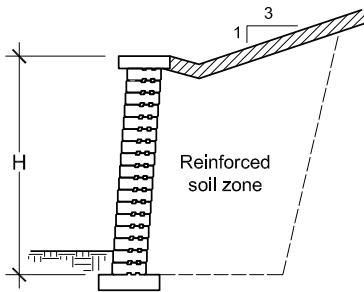

THE DESIGN CHARTS WERE DEVELOPED BASED ON THE FOLLOWING CONDITIONS:

- Geogrid layout determined as per the requirements of the "Design Manual for Segmental Retaining Walls, 3rd Edition" from the National Concrete Masonry Association.
- Geogrid type Miragrid® 3XT from Tencate Mirafi.
- Soil parameters: reinforced soil ($\phi = 36^\circ$, $\gamma = 21 \text{ kN/m}^3$); retained soil ($\phi = 28^\circ$, $\gamma = 20 \text{ kN/m}^3$); foundation soil ($\phi = 28^\circ$, $\gamma = 19 \text{ kN/m}^3$).
- The bearing capacity of the soil, settlement, and global stability must be verified and validated by a qualified geotechnical engineer.
- The seismic analysis was not considered.
- The hydrostatic pressure is not considered. The wall must be provided with an adequate drainage system.
- 6 kPa (125 psf) surcharge (cars and light trucks).
- The design charts do not apply to tiered walls.

For further information, please contact our technical service department.

Email: WALLS@TECHO-BLOC.COM Web site: WWW.TECHO-BLOC.COM

Installation guide

FREESTANDING WALLS - ESCALA 3,5"

ESCALA 3,5"

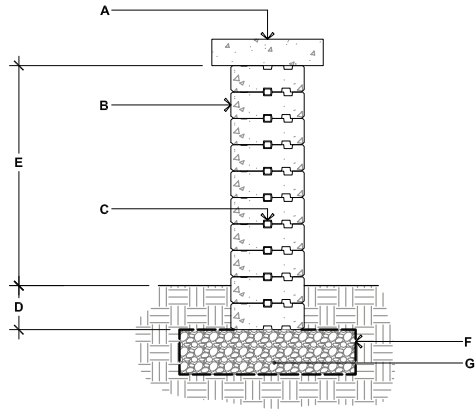

- A.** TECO-BLOC CAP UNIT SECURED TO UNIT BELOW WITH CONCRETE ADHESIVE
- B.** ESCALA 3.5" DOUBLE-SIDED WALL UNIT SECURE EACH ROW WITH CONCRETE ADHESIVE
- C.** CONNECTOR
- D.** EMBEDMENT DEPTH, 6" (150 mm) MIN.
- E.** 750 mm (29 7/16") MAX.
- F.** GEOTEXTILE
- G.** COMPACTED GRANULAR BASE 0-20 mm (0-3/4"), 300 mm (12") THICK MIN.

90° CORNER OF A DOUBLE-SIDED WALL

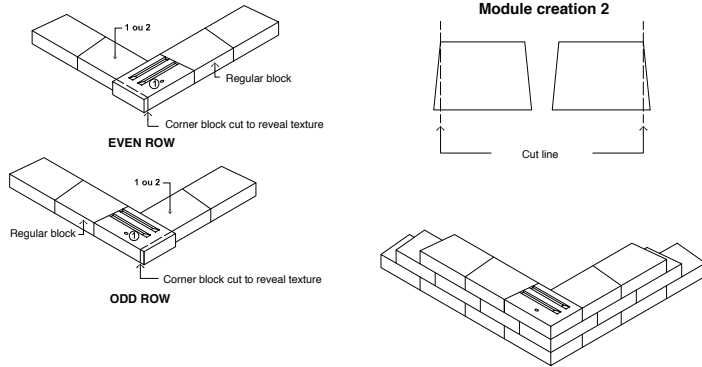

1. Alternate odd and even rows.
2. Stagger joints from one row to the next.
3. Glue all modules at each row with a concrete adhesive.
4. Cavities, grooves and connectors are not illustrated to avoid overloading the image.
5. It is possible to alternate the blocks (A, B or C) in the same row to create different patterns. However, a corner block must always be present at the end of a row and must be alternated for each subsequent row.

DOUBLE-SIDED WALL - END OF A STRAIGHT WALL

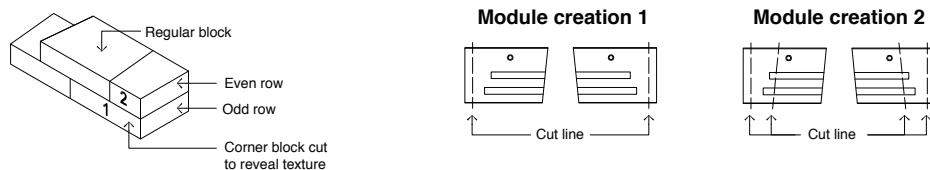

* It is possible to alternate the blocks (A, B or C) in the same row to create different patterns. However, a corner block must always be present at the end of a row and must be alternated for each subsequent row.

Installation guide

DOUBLE-SIDED WALL RADIUS - ESCALA 3.5"

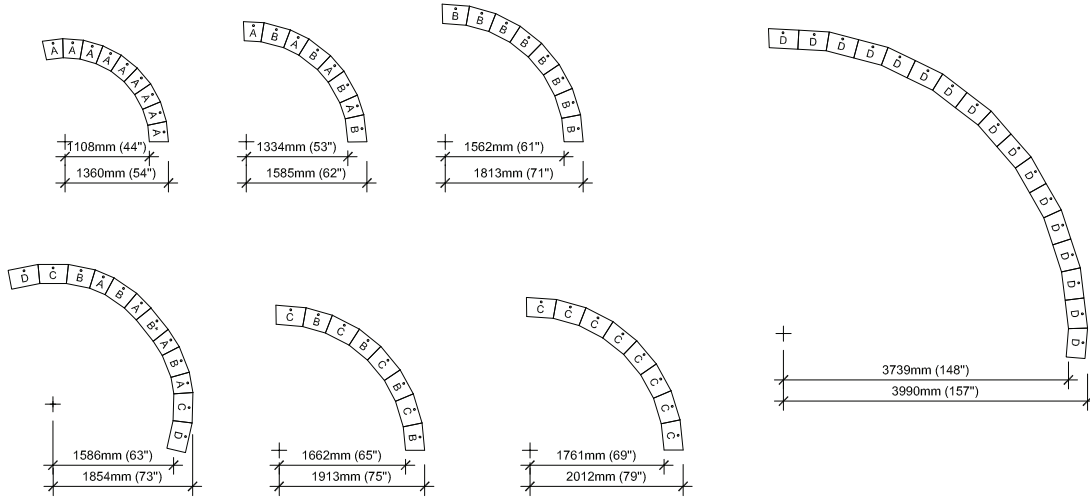

It is the user's responsibility to verify for the quantity of materials required.

STEPS

ESCALA 3.5"

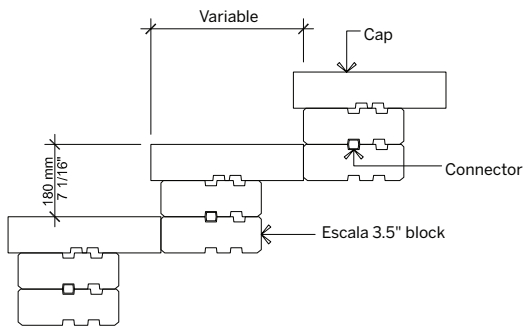

For all possible combinations of walls and caps, please refer to the correspondence table on page 99.

CAP RADIUS - ESCALA 3.5"

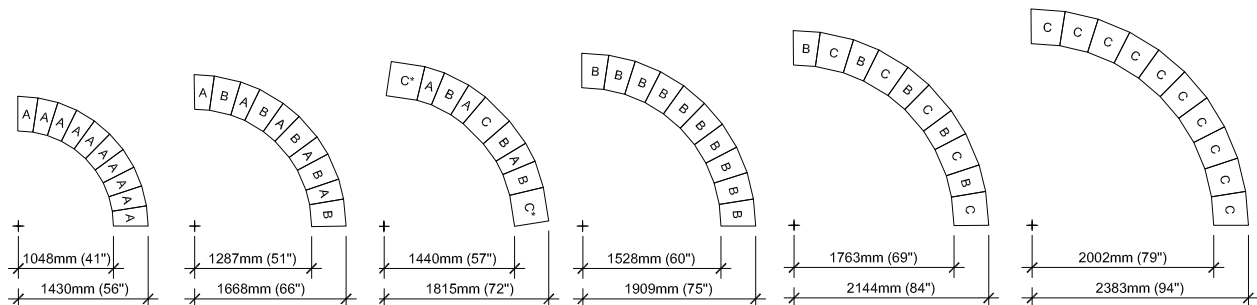

It is the user's responsibility to verify for the quantity of materials required.

Installation guide

G-FORCE

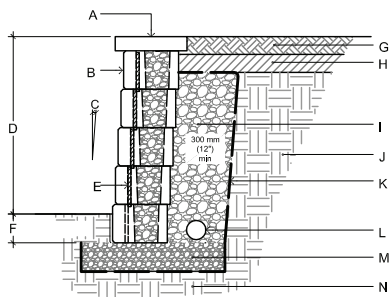

GRAVITY WALL DETAIL

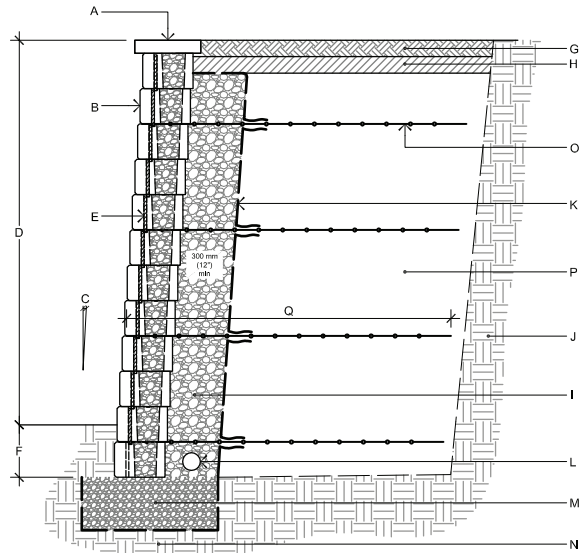

REINFORCED WALL DETAIL

- A. CAP FROM TECO-BLOC
- B. G-FORCE BLOCK FROM TECO-BLOC
- C. WALL INCLINATION (3.9°)
- D. EXPOSED HEIGHT
- E. HDPE VERTICAL KEY
- F. EMBEDMENT DEPTH
- G. TOP SOIL
- H. LOW PERMEABILITY SOIL
- I. 3/4" (20 MM) CLEAN STONE

- J. RETAINED SOIL
- K. GEOTEXTILE
- L. PERFORATED DRAIN
- M. LEVELING PAD
- N. FOUNDATION SOIL
- O. GEOGRID
- P. REINFORCED SOIL
- Q. GEOGRID LENGTH

STEPS - G-FORCE

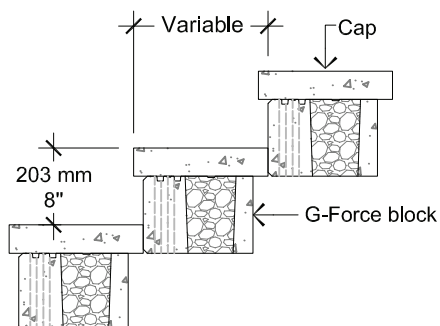

For all possible combinations of walls and caps, please refer to the correspondence table on page 99.

Installation guide

FREESTANDING WALLS - GRAPHIX

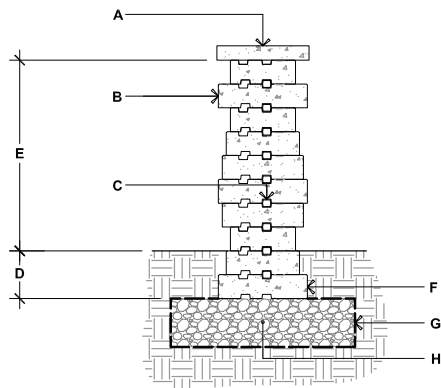

GRAPHIX

- A. TECO-BLOC CAP UNIT SECURED TO UNIT BELOW WITH CONCRETE ADHESIVE
- B. GRAPHIX DOUBLE-SIDED WALL UNITS SECURE EACH ROW WITH CONCRETE ADHESIVE
- C. CONNECTOR
- D. EMBEDMENT DEPTH, 6" (150 mm) MIN.
- E. 23 1/2" (600 mm) MAX.
- F. FOR THE FIRST ROW, ALWAYS USE THE DEEPER GRAPHIX BLOCK
- G. GEOTEXTILE
- H. COMPACTED GRANULAR LEVELING PAD, 12" (300 mm) THICK MIN. THICKNESS ACCORDING TO PROJECT SPECIFIC CONDITIONS

90° CORNER OF A DOUBLE-SIDED WALL

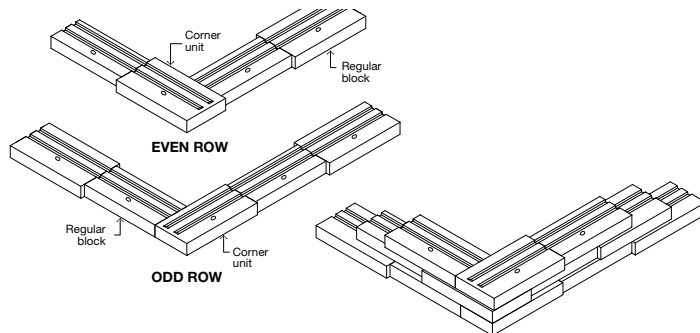

1. Alternate odd and even rows.
2. Stagger joints from one row to the next.
3. Glue all modules at each row with a concrete adhesive.
4. Connectors are not illustrated to avoid overloading the image.
5. It is possible to alternate the blocks (1, 2, 3 or 4) in the same row to create different patterns. However, a corner block (1A, 2A, 3A or 4A) must always be present at the end of a row and must be alternated for each subsequent row.
6. At the corner, make sure to place the blocks so that the grooves of the block cannot be seen.

DOUBLE-SIDED WALL - END OF A STRAIGHT WALL

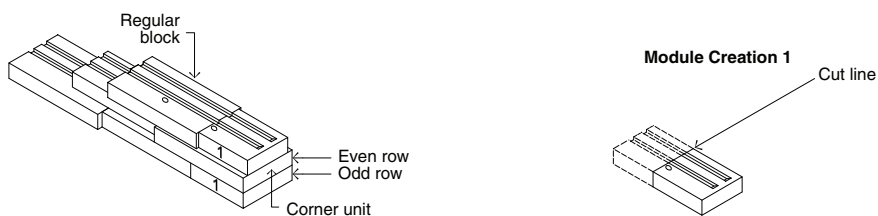

* It is possible to alternate the blocks (1, 2, 3 or 4) in the same row to create different patterns. However, a corner block and a cut corner block (1A, 2A, 3A or 4A) must always be present at the end of a row and must be alternated for each subsequent row.

Installation guide

PILLARS - GRAPHIX

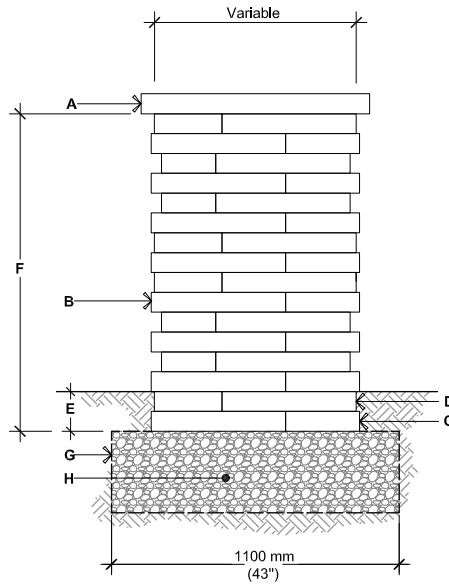

GRAPHIX

- A.** PILLAR CAP UNIT
- B.** GRAPHIX CORNER UNIT
SECURE EACH ROW WITH CONCRETE ADHESIVE
PLACE CONNECTOR IN FRONT GROOVE
- C.** USE THE BLOCKS 1A-3A FOR THE ODD ROWS
- D.** USE THE BLOCKS 2A-4A FOR THE EVEN ROWS
- E.** EMBEDMENT 150 mm DEPTH (6") MIN.
- F.** 600 mm (23 5/8"), HEIGHT PER PALLET
1200 mm (47 1/4"), MAXIMUM HEIGHT
- G.** GEOTEXTILE
- H.** COMPACTED GRANULAR BASE 150 mm (6") THICK MIN. THICKNESS ACCORDING TO PROJECT SPECIFIC CONDITIONS

Installation guide

FREESTANDING WALLS - MANCHESTER

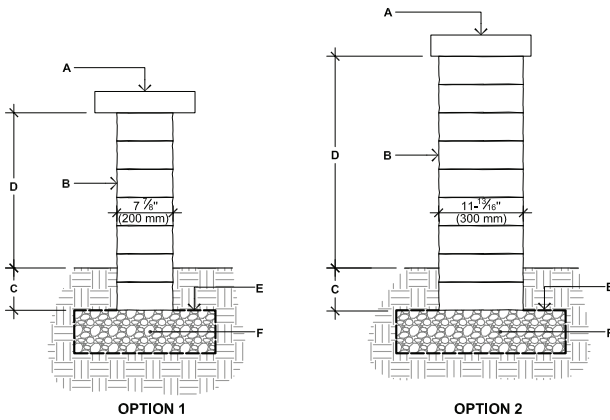

MANCHESTER

- A. TECO-BLOC CAP UNIT SECURED TO UNIT BELOW WITH CONCRETE ADHESIVE
- B. MANCHESTER DOUBLE-SIDED WALL UNITS SECURE EACH ROW WITH CONCRETE ADHESIVE
- C. EMBEDMENT DEPTH, 150 mm (6") MIN.
- D. 550 mm (21 9/16") MAX. FOR BLOCK DEPTH OF 200 mm (7 7/8")
- D. 750 mm (29 7/16") MAX. FOR BLOCK DEPTH OF 300 mm (11 13/16")
- E. GEOTEXTILE
- F. COMPACTED GRANULAR BASE 0-20 mm (0-3/4"), 300 mm (12") THICK MIN.

90° CORNER OF A DOUBLE-SIDED WALL

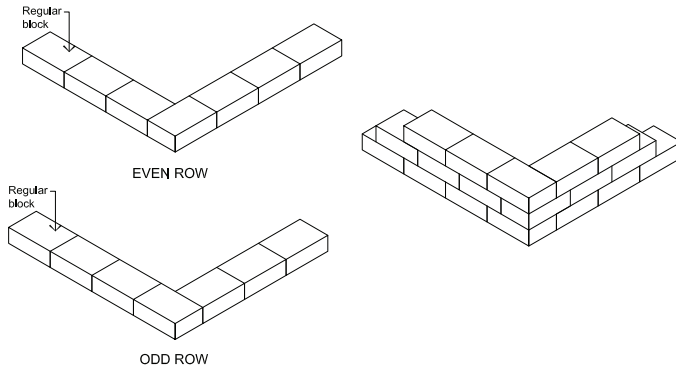

1. Alternate odd and even rows.
2. Stagger joints from one row to the next.
3. Glue all modules at each row with a concrete adhesive.

DOUBLE-SIDED WALL - END OF A STRAIGHT WALL

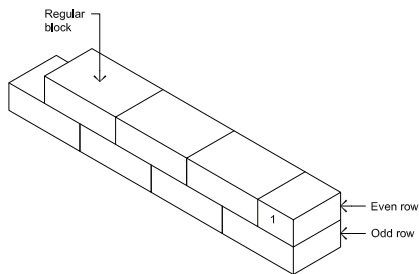

1. Alternate odd and even rows.
2. Stagger joints from one row to the next.
3. Glue all modules at each row with a concrete adhesive.

Installation guide

PILLARS - MANCHESTER

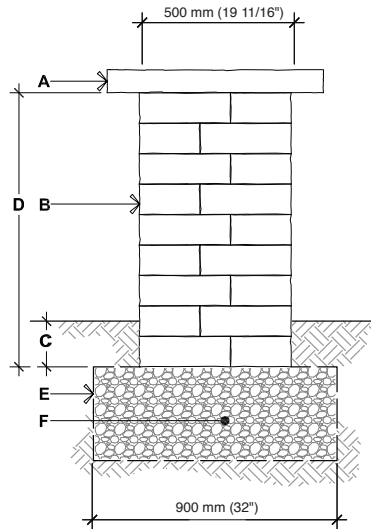

MANCHESTER PILLAR

- A. PILLAR CAP UNIT
(SECURE WITH CONCRETE ADHESIVE)
- B. MANCHESTER UNIT SECURE EACH ROW
WITH CONCRETE ADHESIVE
- C. EMBEDMENT 6" (150 mm) MIN.
- D. 35 7/16" (900 mm), HEIGHT PER PALLET
47 1/4" (1200 mm), MAXIMUM HEIGHT
- E. GEOTEXTILE
- F. COMPACTED GRANULAR BASE 150 mm (6")
THICK MIN. THICKNESS ACCORDING TO
PROJECT SPECIFIC CONDITIONS

For all possible combinations of pillars and caps, please refer to the correspondence table on page 99.

Installation guide

RETAINING WALL DESIGN CHART - MINI-CRETA 6"

EQUIVALENT TO TWICE THE MINI-CRETA 3"

The information contained in the design charts is supplied for information purposes only. Techo-Bloc and its predecessors, successors, beneficiaries, employees, associates, administrators and insurers can not under any circumstances be held liable for the incorrect use of information contained in design charts. **This chart should be read in conjunction with the notes on page 103.**

CASE N° 1

Inclined wall (5°)
Surcharge: 6 kPa

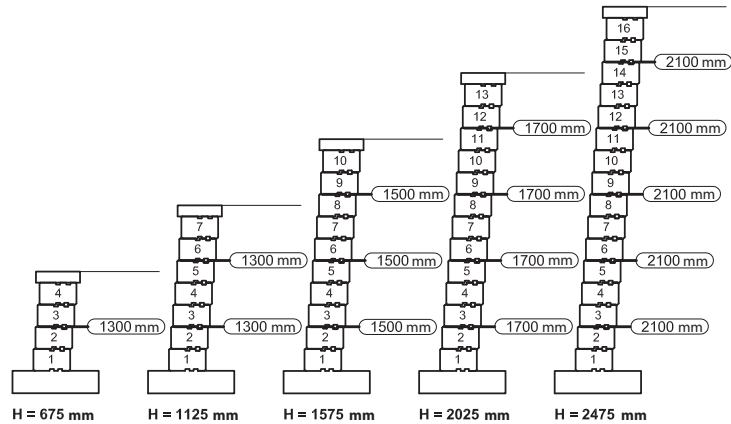
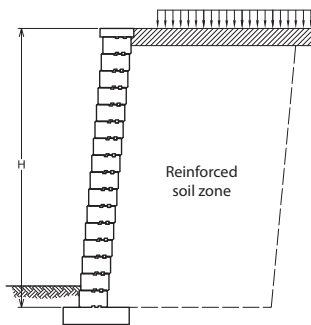

CASE N° 2

Inclined wall (5°)
Slope: 1V:3H

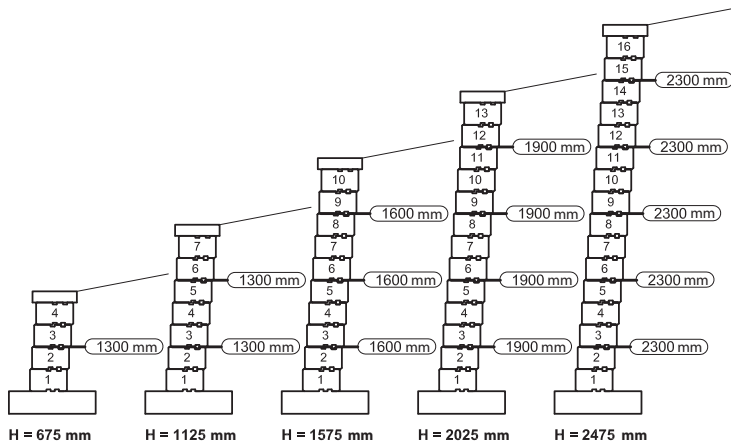
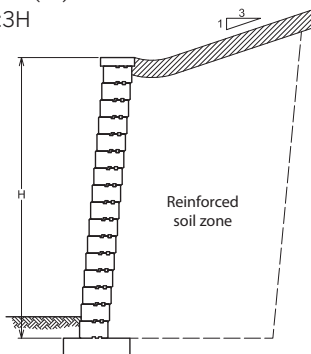

THE DESIGN CHARTS WERE DEVELOPED BASED ON THE FOLLOWING CONDITIONS:

- Geogrid layout determined as per the requirements of the "Design Manual for Segmental Retaining Walls, 3rd Edition" from the National Concrete Masonry Association.
- Geogrid type Miragrid® 3XT from Tencate Mirafi.
- Soil parameters: reinforced soil ($\phi = 36^\circ$, $\gamma = 21 \text{ kN/m}^3$); retained soil ($\phi = 28^\circ$, $\gamma = 20 \text{ kN/m}^3$); foundation soil ($\phi = 28^\circ$, $\gamma = 19 \text{ kN/m}^3$).
- The bearing capacity of the soil, settlement, and global stability must be verified and validated by a qualified geotechnical engineer.
- The seismic analysis was not considered.
- The hydrostatic pressure is not considered. The wall must be provided with an adequate drainage system.
- 6 kPa (125 psf) surcharge (cars and light trucks).
- The design charts do not apply to tiered walls.

For further information, please contact our technical service department.

Email: WALLS@TECHO-BLOC.COM Web site: WWW.TECHO-BLOC.COM

Installation guide

RETAINING WALLS - MINI-CRETA 3" AND 6"

These patterns have been developed to capture the look of hand-laid stone. For each pattern, a ratio of quantity is provided, which will guide you in estimating the overall material required for a given project.

1-row pattern | Laying patterns

The 1-row pattern provides five different combinations. Each combination is 8.9' (2.7 m) long and 5 7/8" (150 mm) high. **This pattern can be used to lay the last course of units or when the other models cannot be used.**

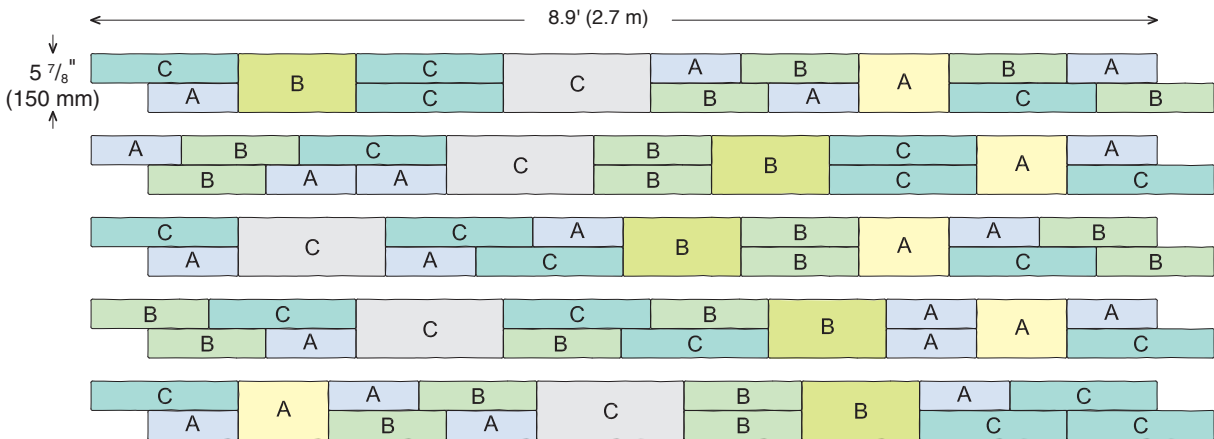

NUMBER OF BLOCKS REQUIRED

MINI-CRETA

67% of the surface - Mini-Creta 3"

33% of the surface - Mini-Creta 6"

MODULE

A	B OR B*	C OR D
4	4	4
1	1	1

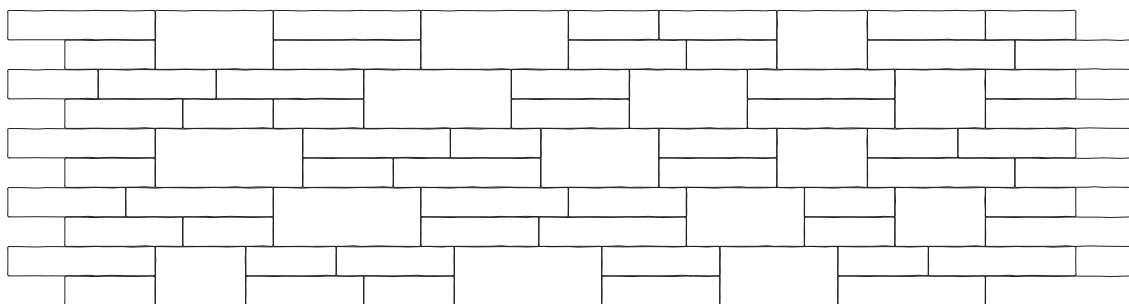

Installation guide

RETAINING WALLS - MINI-CRETA 3" AND 6"

3-row pattern | Laying patterns

The 3-row pattern provides four different combinations. Each combination is 8.9' (2.7 m) long and 17¹/₁₆" (450 mm) high. This pattern gives a leveled surface every 17¹/₁₆" (450 mm), which is the recommended spacing between two layers of geogrid in a Mini-Creta wall. **This pattern is recommended when using geogrid.**

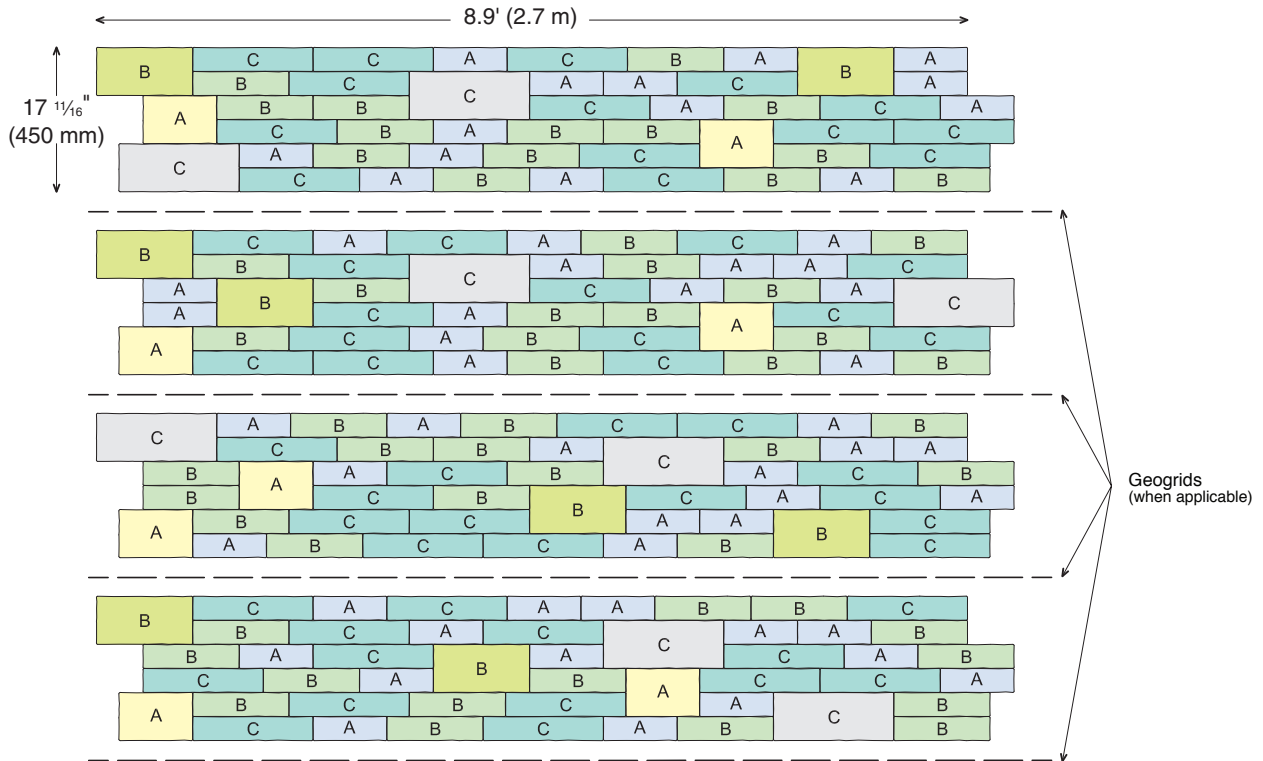

NUMBER OF BLOCKS REQUIRED

MINI-CRETA	MODULE		
	A	B OR B*	C OR D
78% of the surface - Mini-Creta 3"	14	14	14
22% of the surface - Mini-Creta 6"	2	2	2

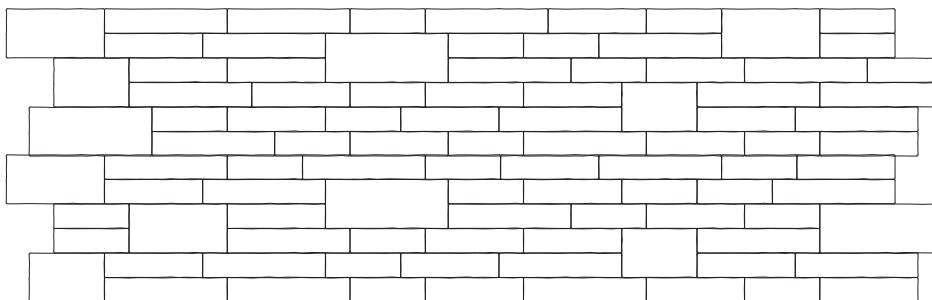

Installation guide

RETAINING WALLS - MINI-CRETA 3" AND 6"

5-row pattern | Laying patterns

The 5-row pattern provides three different combinations. Each combination is 8.9' (2.7 m) long and 29 1/2" (750 mm) high. **This pattern should only be used when geogrid is not required.**

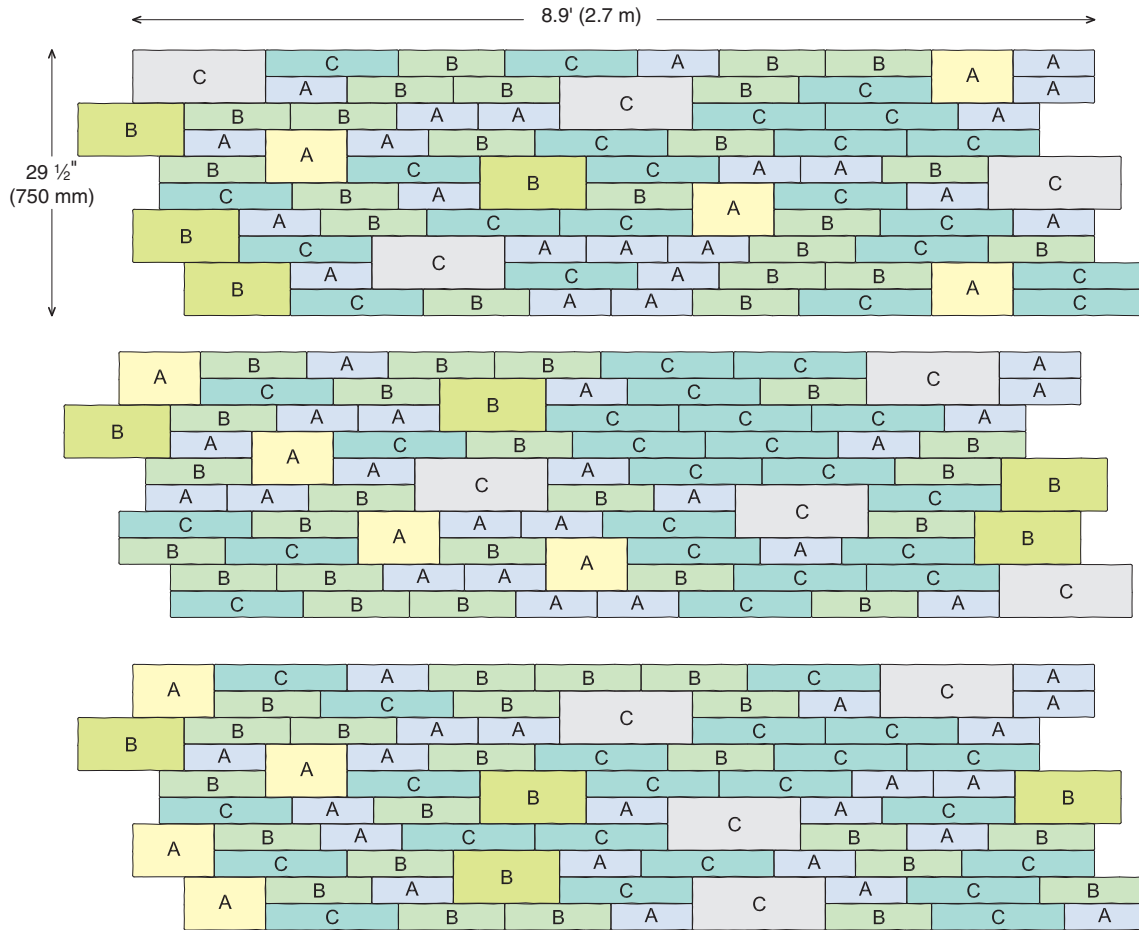

NUMBER OF BLOCKS REQUIRED

MODULE

MINI-CRETA	A	B OR B*	C OR D
73% of the surface - Mini-Creta 3"	22	22	22
27% of the surface - Mini-Creta 6"	4	4	4

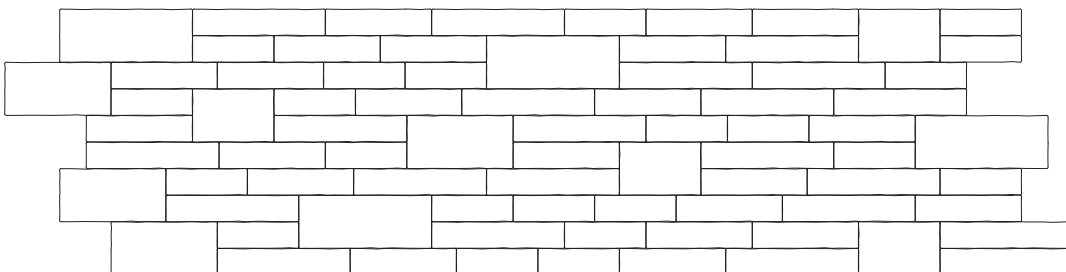

Installation guide

FREESTANDING WALLS - MINI-CRETA 3" AND 6"

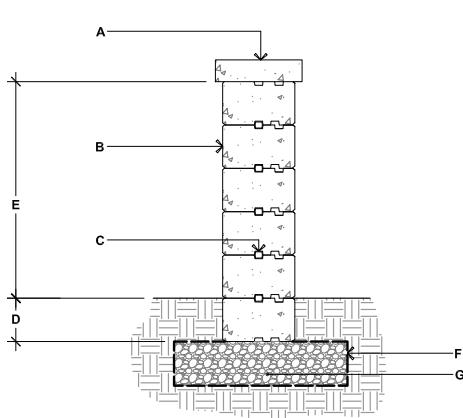

MINI-CRETA 3" & 6"

- A. TECHO-BLOC CAP UNIT SECURED TO UNIT BELOW WITH CONCRETE ADHESIVE
- B. MINI-CRETA 3" AND 6" DOUBLE-SIDED WALL UNITS SECURE EACH ROW WITH CONCRETE ADHESIVE
- C. CONNECTOR
- D. EMBEDMENT DEPTH, 6" (150 mm) MIN.
- E. 29 7/16" (750 mm) MAX.
- F. GEOTEXTILE
- G. COMPACTED GRANULAR LEVELING PAD, 12" (300 mm) THICK MIN. THICKNESS ACCORDING TO PROJECT SPECIFIC CONDITIONS

90° CORNER OF A DOUBLE-SIDED WALL

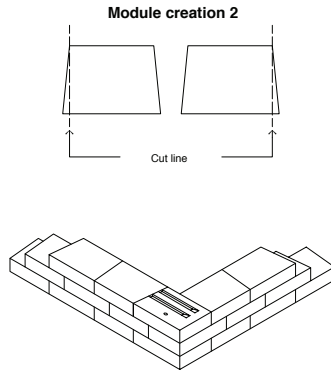
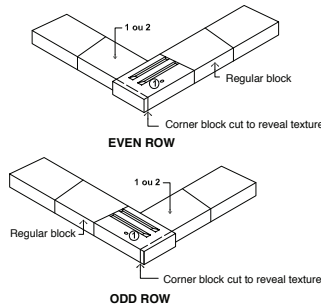

The corner block must be cut to reveal the texture

1. Alternate odd and even rows.
2. Stagger joints from one row to the next.
3. Glue all modules at each row with a concrete adhesive.
4. Cavities, grooves and connectors are not illustrated to avoid overloading the image.
5. It is possible to alternate the blocks (A, B or C) in the same row to create different patterns. However, a corner block must always be present at the end of a row and must be alternated for each subsequent row.

DOUBLE-SIDED WALL - END OF A STRAIGHT WALL

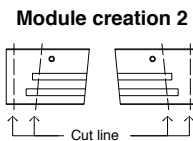
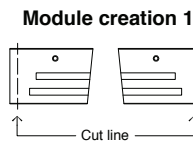
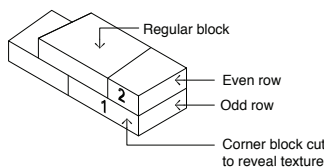

* It is possible to alternate the blocks (A, B or C) in the same row to create different patterns. However, a corner block must always be present at the end of a row and must be alternated for each subsequent row.

Installation guide

DOUBLE-SIDED WALL RADIUS - MINI-CRETA 3" AND 6"

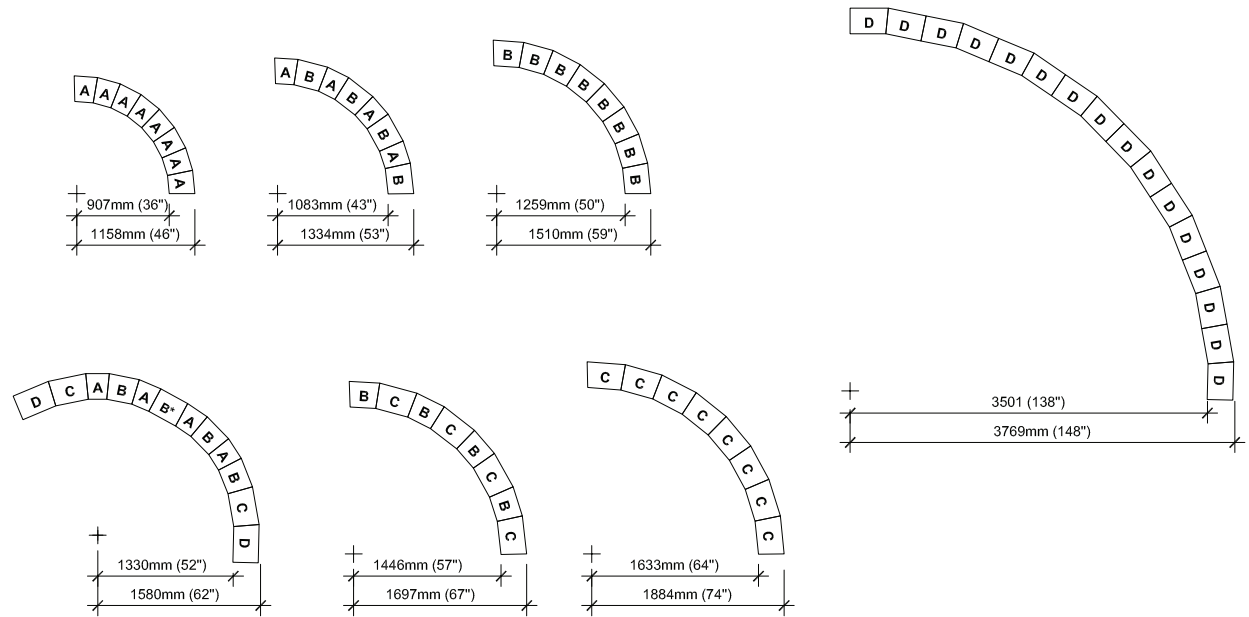

It is the user's responsibility to verify for the quantity of materials required.

STEPS

MINI-CRETA 3"

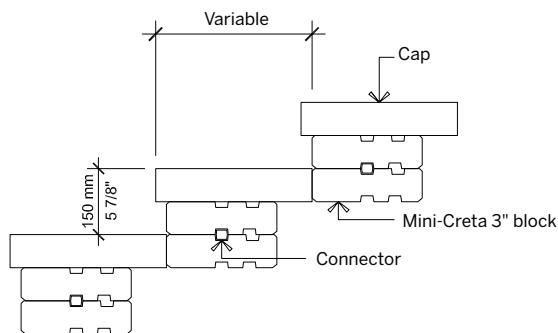

MINI-CRETA 6"

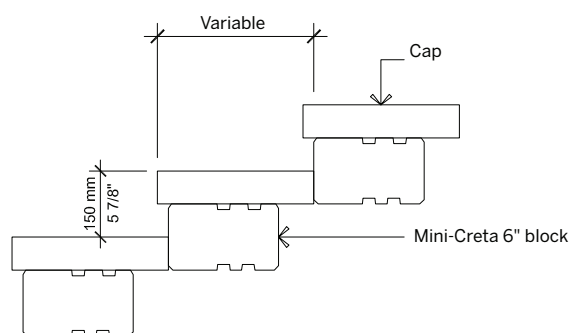

For all possible combinations of walls and caps, please refer to the correspondence table on page 99.

Installation guide

GRILL ISLAND 6 FT - MINI-CRETA 3" AND 6"

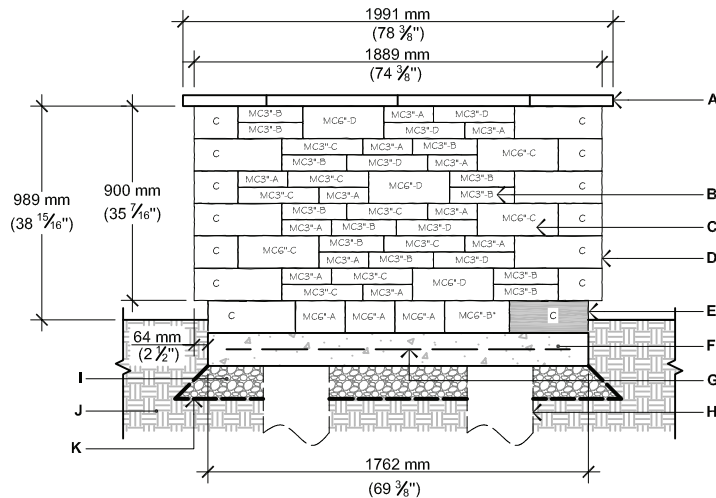
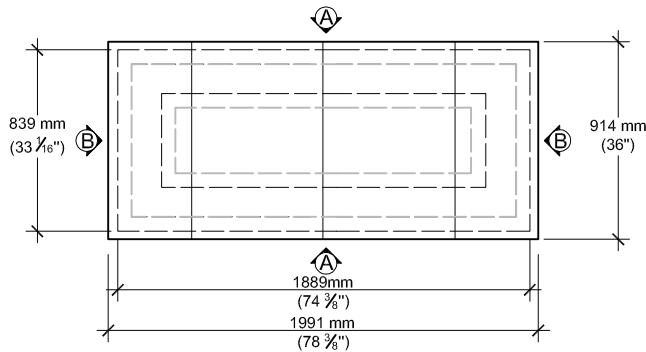

ELEVATION A

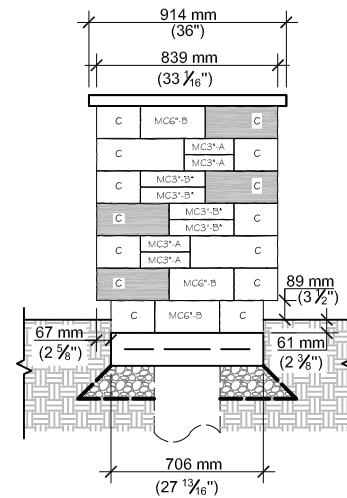

ELEVATION B



NOTE:

When installing the built-in grill, refer to the manufacturer's instruction guide for all specifications and requirements for natural gas or propane tank location, installation and ventilation.

- A. YORK COUNTER TOP 24" × 36" × 2 1/4"
- B. MINI-CRETA 3" UNIT (A, B, B*, C, OR D)
- C. MINI-CRETA 6" UNIT (A, B, B*, C, OR D)
- D. PILLAR 24" × 36" (MINI-CRETA) UNIT
- E. PILLAR 24" × 36" (MINI-CRETA) UNIT (CUT ON FIELD)
- F. CAST IN PLACE CONCRETE SLAB 4350 PSI (30 MPA), 5" (125 MM) THICK
- G. 4X4-4/4 (102X102-MW25.8XMW25.8) WELDED WIRE MESH AND/OR REBAR AS PER SITE CONDITIONS
- H. 12" (300 MM) DIA. CONCRETE PILLAR, AS PER LOCAL CODE
- I. 3/4" (20 MM) CLEAN STONE
- J. 6" (150 MM) THICK MIN. AS PER SITE CONDITIONS
- K. NATURAL SOIL OR COMPACTED BACKFILL
- K. GEOTEXTILE

QUANTITY OF MATERIALS REQUIRED

- York Counter top 24" × 36" × 2 1/4": **4**
- Mini-Creta 3" unit: **32 A, 24 B, 8 B*, 14 C, 10 D**
- Mini-Creta 6" unit: **6 A, 6 B, 2 B*, 6 C, 6 D**
- Pillar 24" × 6" (Mini-Creta) unit: **28**

NOTE: Appliances and utilities may vary for each project and are not shown on this drawing. This drawing is shown for inspiration only and surplus or shortage of materials may result. It is the user's responsibility to verify for the quantity of materials required. Secure the blocks using a heat resistant concrete adhesive. The installer must ensure that the installation and use of the grill island comply with local regulations and code requirements. Concrete pillars extending to frost line may be required as per local code. Check your local building code before installing.

Installation guide

PILLARS- MINI-CRETA 3" AND 6"

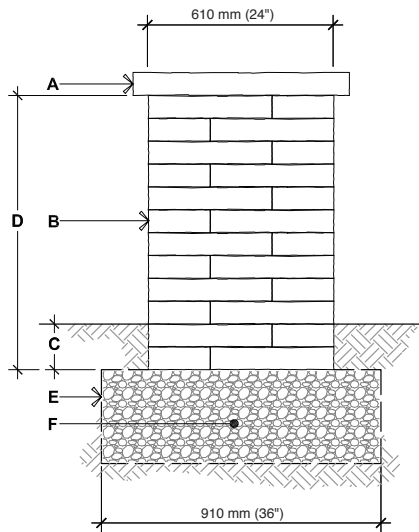

PILLAR 24"×3"

MINI-CRETA

- A. PILLAR CAP UNIT
(SECURE WITH CONCRETE ADHESIVE)
- B. PILLAR 24" × 3" (MINI-CRETA) UNIT
SECURE EACH ROW WITH CONCRETE
ADHESIVE
- C. EMBEDMENT 6" (150 mm) MIN.
- D. 35 7/16" (900 mm), HEIGHT PER PALLET
47 1/4" (1200 mm), MAXIMUM HEIGHT
- E. GEOTEXTILE
- F. COMPACTED GRANULAR BASE 150 mm
(6") THICK MIN. THICKNESS ACCORDING
TO PROJECT SPECIFIC CONDITIONS

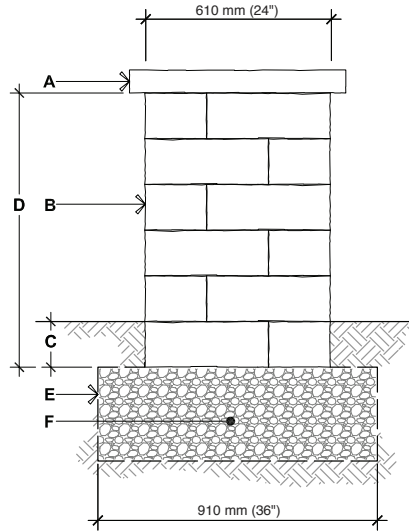

PILLAR 24"×6"

MINI-CRETA

- A. PILLAR CAP UNIT
(SECURE WITH CONCRETE ADHESIVE)
- B. PILLAR 24" × 6" (MINI-CRETA) UNIT
SECURE EACH ROW WITH CONCRETE
ADHESIVE
- C. EMBEDMENT 6" (150 mm) MIN.
- D. 35 7/16" (900 mm), HEIGHT PER PALLET
47 1/4" (1200 mm), MAXIMUM HEIGHT
- E. GEOTEXTILE
- F. COMPACTED GRANULAR BASE 150 mm (6")
THICK MIN. THICKNESS ACCORDING TO
PROJECT SPECIFIC CONDITIONS

For all possible combinations of pillars and caps, please refer to the correspondence table on page 99.

Installation guide

PILLARS- MINI-CRETA 3" AND 6"

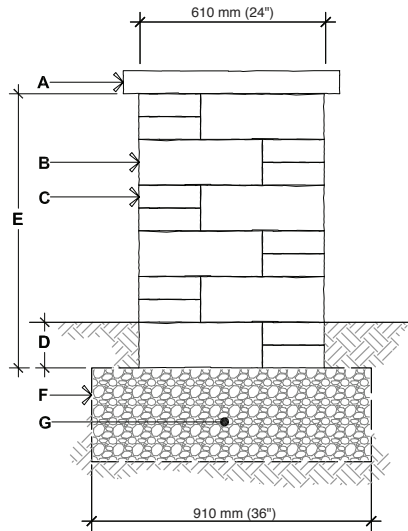

PILLAR 24"×3" & 24"×6"
MINI-CRETA - OPTION A

- A.** PILLAR CAP UNIT
(SECURE WITH CONCRETE ADHESIVE)
- B.** PILLAR 24" × 6" (MINI-CRETA) UNIT
SECURE EACH ROW WITH CONCRETE ADHESIVE
- C.** PILLAR 24" × 3" (MINI-CRETA) UNIT
SECURE EACH ROW WITH CONCRETE ADHESIVE
- D.** EMBEDMENT 6" (150 mm) MIN.
- E.** 35 7/16" (900 mm)
47 1/4" (1200 mm), MAXIMUM HEIGHT
- F.** GEOTEXTILE
- G.** COMPACTED GRANULAR BASE 150 mm (6")
THICK MIN. THICKNESS ACCORDING TO
PROJECT SPECIFIC CONDITIONS

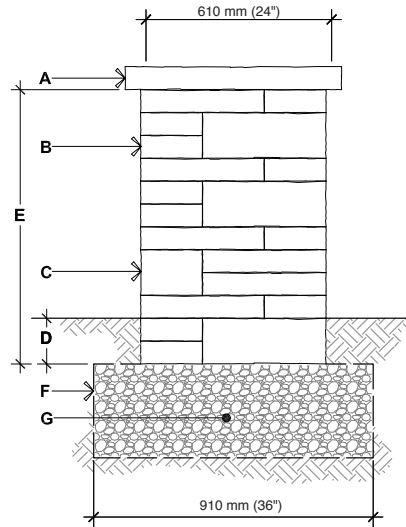

PILLAR 24"×3" & 24"×6"
MINI-CRETA - OPTION B

- A.** PILLAR CAP UNIT
(SECURE WITH CONCRETE ADHESIVE)
- B.** PILLAR 24" × 3" (MINI-CRETA) UNIT
SECURE EACH ROW WITH CONCRETE ADHESIVE
- C.** PILLAR 24" × 6" (MINI-CRETA) UNIT
SECURE EACH ROW WITH CONCRETE ADHESIVE
- D.** EMBEDMENT 6" (150 mm) MIN.
- E.** 35 7/16" (900 mm)
47 1/4" (1200 mm), MAXIMUM HEIGHT
- F.** GEOTEXTILE
- G.** COMPACTED GRANULAR BASE 150 mm (6")
THICK MIN. THICKNESS ACCORDING TO
PROJECT SPECIFIC CONDITIONS

For all possible combinations of pillars and caps, please refer to the correspondence table on page 99.

Installation guide

RETAINING WALLS - PRESCOTT 2.25" & 4.5"

These patterns have been developed to capture the look of hand-laid stone. For each pattern, a ratio of quantity is provided, which will guide you in estimating the overall material required for a given project.

1-row pattern | Laying patterns

The single row model shows two examples of combination. Each combination is 2.438 m (8") long and 114 mm (4 1/2") high. **This model can be used for installing the last row of modules or where other models cannot be used.**

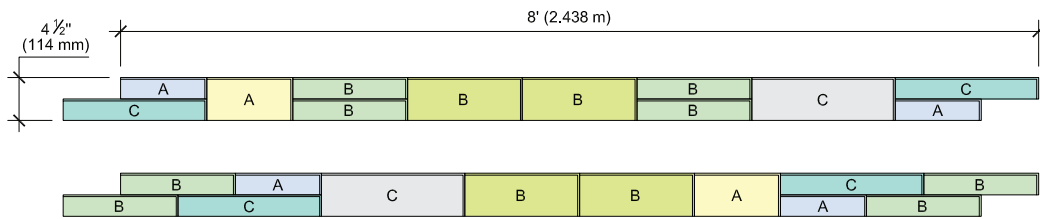

NUMBER OF BLOCKS REQUIRED

MODULE

PRESCOTT	A	B	C
50% of the surface - Prescott 2.25"	2	4	2
50% of the surface - Prescott 4.5"	1	2	1

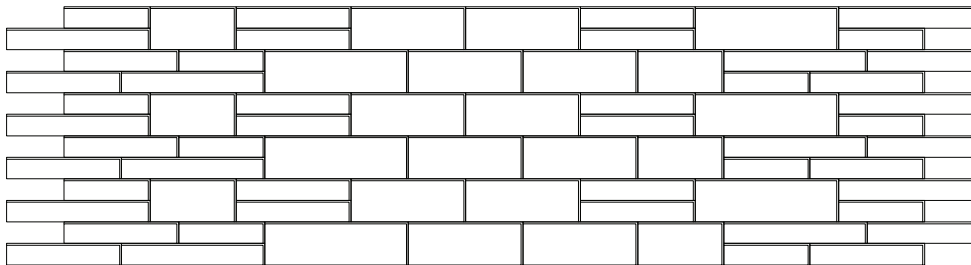

Installation guide

RETAINING WALLS - PRESCOTT 2.25" & 4.5"

4-row pattern | Laying patterns

The 4-row model is 1.83 m (6') long and 457 mm (18") high. This model allows for a graded area at every 457 mm (18"), which corresponds to the recommended spacing between the layers of geogrid in a Prescott wall. **This model is recommended when using geogrid.**

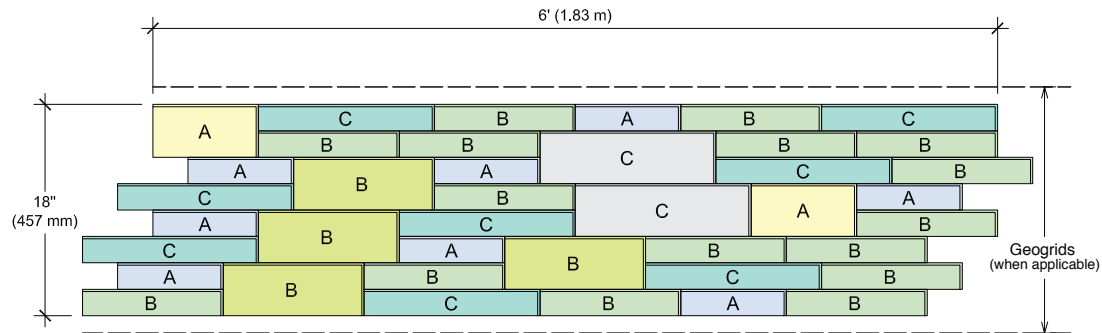

NUMBER OF BLOCKS REQUIRED

MODULE

PRESCOTT

67% of the surface - Prescott 2.25"

A
8

B
16

C
8

33% of the surface - Prescott 4.5"

2

4

2

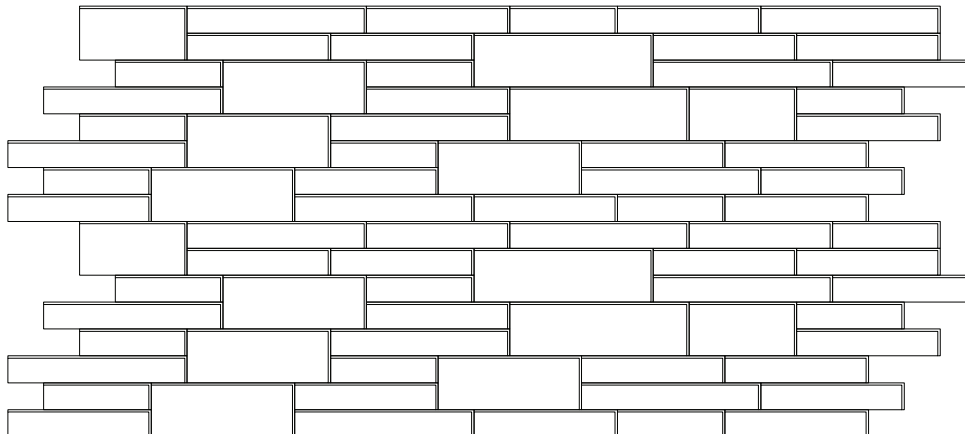

Installation guide

RETAINING WALLS - PRESCOTT 2.25" & 4.5"

6-row pattern | Laying patterns

The 6-row model shows two combination examples. This combination is 1.829 m (6') long and 686 mm (27") high. **This model should only be used where geogrid is not required.**

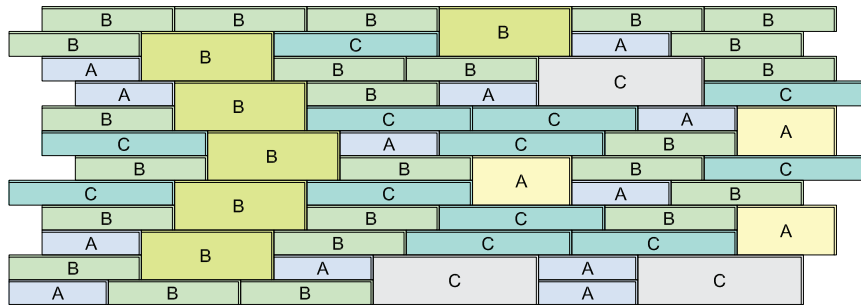
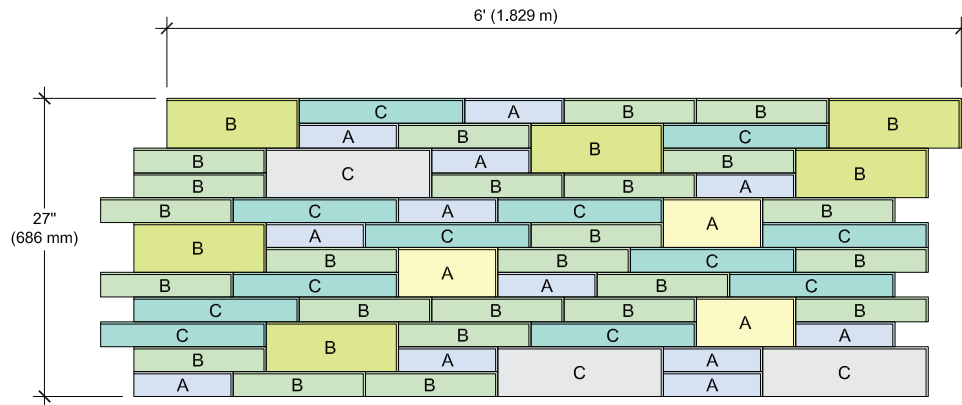

NUMBER OF BLOCKS REQUIRED

MODULE

PRESCOTT

67% of the surface - Prescott 2.25"

A

B

C

33% of the surface - Prescott 4.5"

12

24

12

3

6

3

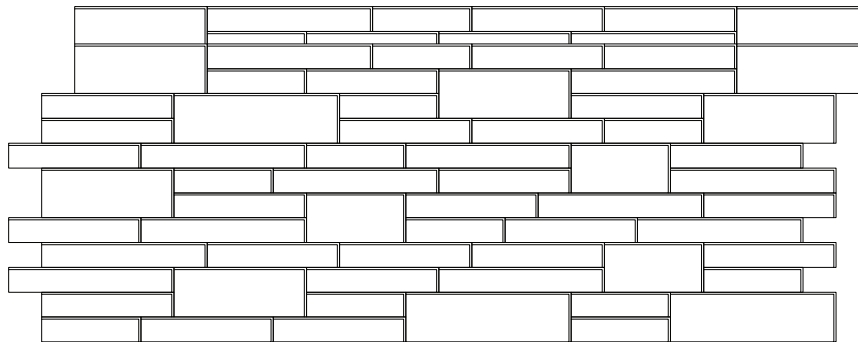

Installation guide

FREESTANDING WALLS - PRESCOTT 2.25" & 4.5"

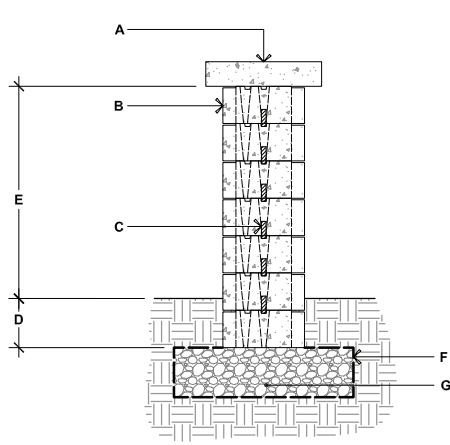

PRESCOTT 2.25" & 4.5"

- A. TECO-BLOC CAP UNIT, SECURED TO UNIT BELOW WITH CONCRETE ADHESIVE
- B. PRESCOTT 2.25" AND 4.5" DOUBLE-SIDED WALL UNITS
SECURE EACH ROW WITH CONCRETE ADHESIVE
- C. CONNECTOR
- D. EMBEDMENT DEPTH, 6" (150 mm) MIN.
- E. 25 1/2" (650 mm) MAX.
- F. GEOTEXTILE
- G. COMPACTED GRANULAR LEVELING PAD, 12" (300 mm) THICK MIN. THICKNESS
ACCORDING TO PROJECT SPECIFIC CONDITIONS

90° CORNER OF A DOUBLE-SIDED WALL

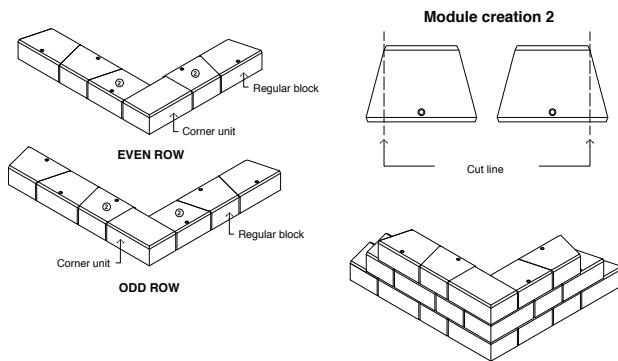

DOUBLE-SIDED WALL - END OF A STRAIGHT WALL

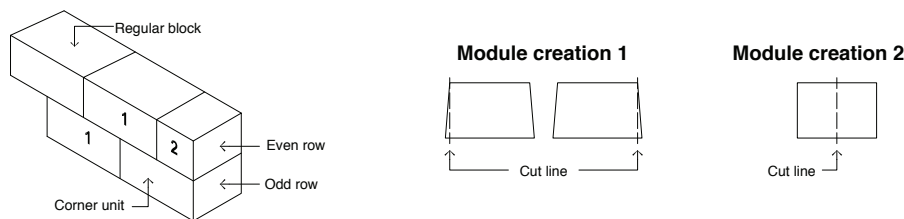

GENERAL NOTES

1. Alternate odd and even rows.
2. Stagger joints from one row to the next.
3. Glue all modules at each row with a concrete adhesive.
4. Cavities, grooves and connectors are not illustrated to avoid overloading the image.

Installation guide

DOUBLE-SIDED WALL RADIUS - PRESCOTT 2.25" & 4.5"

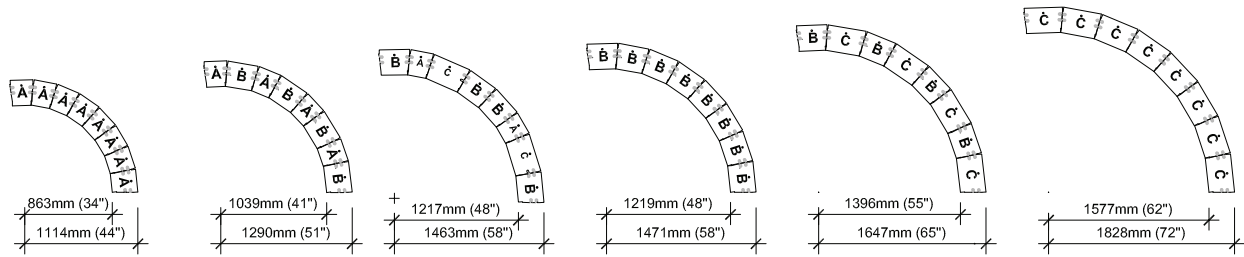

It is the user's responsibility to verify for the quantity of materials required.

STEPS

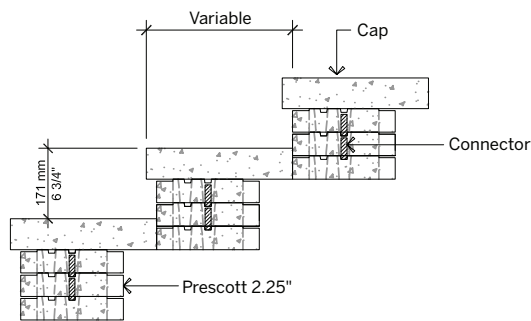

For all possible combinations of walls and caps, please refer to the correspondence table on page 99.

Installation guide

PILLARS - PRESCOTT 2.25" & 4.5"

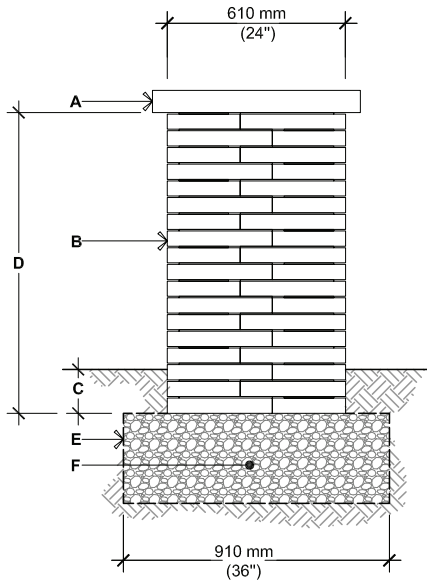

○ PRESCOTT 2.25"

- A. PILLAR CAP UNIT
(SECURE WITH CONCRETE ADHESIVE)
- B. PRESCOTT 2.25" PILLAR UNIT SECURE EACH ROW WITH CONCRETE ADHESIVE
- C. EMBEDMENT DEPTH, 6" (150 mm) MIN.
- D. 40 1/2" (1 029 mm), HEIGHT PER PALLET
45" (1 143 mm), MAX. HEIGHT
- E. GEOTEXTILE
- F. COMPACTED GRANULAR BASE 6" (150 mm)
THICK MIN. THICKNESS ACCORDING TO
PROJECT SPECIFIC CONDITIONS

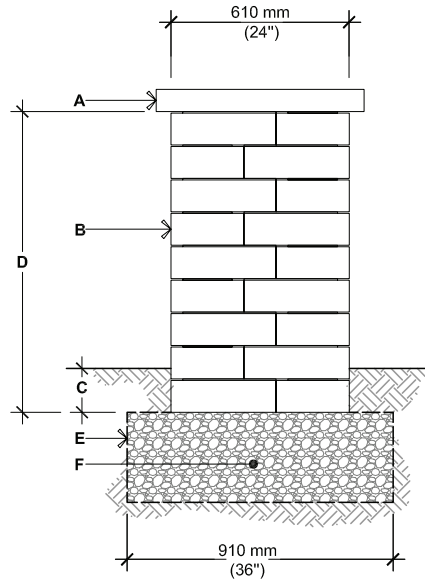

○ PRESCOTT 4.5"

- A. PILLAR CAP UNIT
(SECURE WITH CONCRETE ADHESIVE)
- B. PRESCOTT 4.5" PILLAR UNIT SECURE EACH ROW WITH CONCRETE ADHESIVE
- C. EMBEDMENT DEPTH, 6" (150 mm) MIN.
- D. 40 1/2" (1 029 mm), HEIGHT PER PALLET
45" (1 143 mm), MAX. HEIGHT
- E. GEOTEXTILE
- F. COMPACTED GRANULAR BASE
6" (150 mm) THICK MIN. THICKNESS
ACCORDING TO PROJECT SPECIFIC
CONDITIONS

For all possible combinations of pillars and caps, please refer to the correspondence table on page 99.

Installation guide

PILLARS - PRESCOTT 2.25" & 4.5"

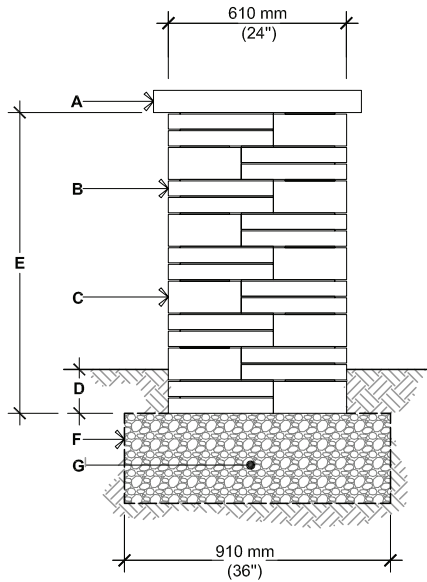

PRESCOTT 2.25" & 4.5"
OPTION A

- A.** PILLAR CAP UNIT
(SECURE WITH CONCRETE ADHESIVE)
- B.** PRESCOTT 2.25" PILLAR UNIT SECURE EACH ROW WITH CONCRETE ADHESIVE
- C.** PRESCOTT 4.5" PILLAR UNIT SECURE EACH ROW WITH CONCRETE ADHESIVE
- D.** EMBEDMENT DEPTH, 6" (150 mm) MIN.
- E.** 40 1/2" (1 029 mm)
45" (1 143 mm), MAX. HEIGHT
- F.** GEOTEXTILE
- G.** COMPACTED GRANULAR BASE 6" (150 mm) THICK MIN. THICKNESS ACCORDING TO PROJECT SPECIFIC CONDITIONS

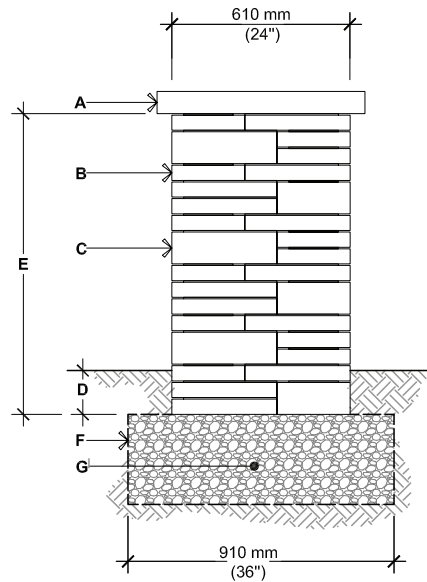

PRESCOTT 2.25" & 4.5"
OPTION B

- A.** PILLAR CAP UNIT
(SECURE WITH CONCRETE ADHESIVE)
- B.** PRESCOTT 2.25" PILLAR UNIT SECURE EACH ROW WITH CONCRETE ADHESIVE
- C.** PRESCOTT 4.5" PILLAR UNIT SECURE EACH ROW WITH CONCRETE ADHESIVE
- D.** EMBEDMENT DEPTH, 6" (150 mm) MIN.
- E.** 40 1/2" (1 029 mm)
45" (1 143 mm), MAX. HEIGHT
- F.** GEOTEXTILE
- G.** COMPACTED GRANULAR BASE 6" (150 mm) THICK MIN. THICKNESS ACCORDING TO PROJECT SPECIFIC CONDITIONS

For all possible combinations of pillars and caps, please refer to the correspondence table on page 99.

Installation guide

RETAINING WALL DESIGN CHART - RAFFINATO 180 MM

EQUIVALENT TO TWICE THE RAFFINATO 90 mm

The information contained in the design charts is supplied for information purposes only. Techo-Bloc and its predecessors, successors, beneficiaries, employees, associates, administrators and insurers can not under any circumstances be held liable for the incorrect use of information contained in design charts. **This chart should be read in conjunction with the notes on page 103.**

CASE N° 1

Inclined wall (4.4°)

Surcharge: 6 kPa

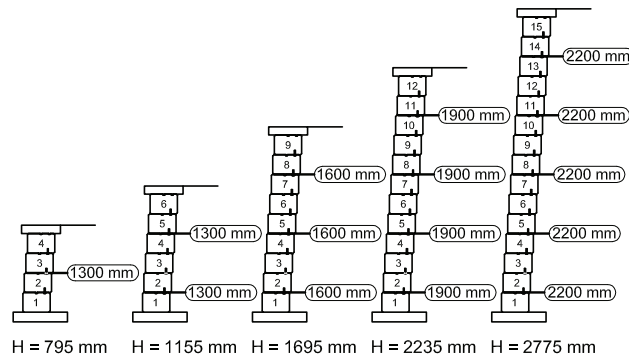
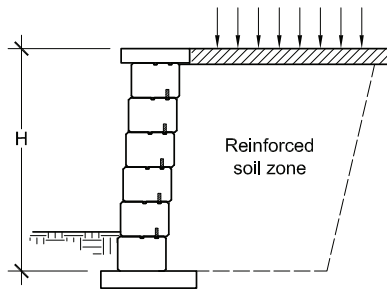

CASE N° 2

Inclined wall (4.4°)

Slope: 1V:3H

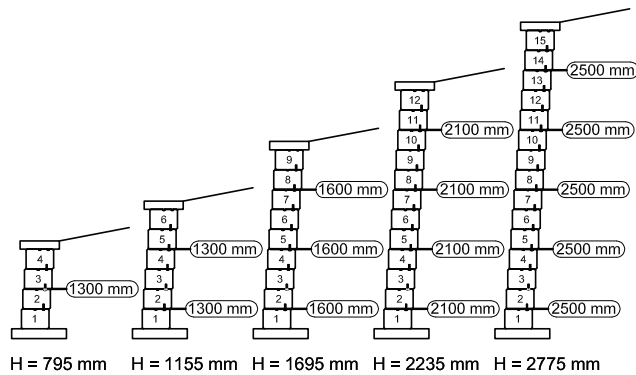
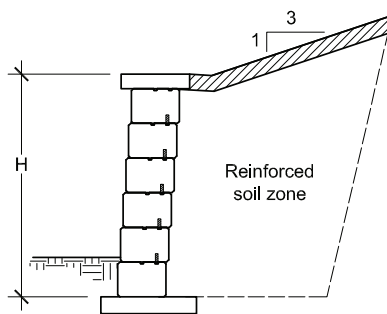

THE DESIGN CHARTS WERE DEVELOPED BASED ON THE FOLLOWING CONDITIONS:

- Geogrid layout determined as per the requirements of the "Design Manual for Segmental Retaining Walls, 3rd Edition" from the National Concrete Masonry Association.
- Geogrid type Miragrid® 3XT from Tencate Mirafi.
- Soil parameters: reinforced soil ($\phi = 36^\circ$, $\gamma = 21 \text{ kN/m}^3$); retained soil ($\phi = 28^\circ$, $\gamma = 20 \text{ kN/m}^3$); foundation soil ($\phi = 28^\circ$, $\gamma = 19 \text{ kN/m}^3$).
- The bearing capacity of the soil, settlement, and global stability must be verified and validated by a qualified geotechnical engineer.
- The seismic analysis was not considered.
- The hydrostatic pressure is not considered. The wall must be provided with an adequate drainage system.
- 6 kPa (125 psf) surcharge (cars and light trucks).
- The design charts do not apply to tiered walls.

For further information, please contact our technical service department.

Email: WALLS@TECHO-BLOC.COM Web site: WWW.TECHO-BLOC.COM

Installation guide

RETAINING WALLS - RAFFINATO 90 MM & 180 MM

These patterns have been developed to capture the look of hand-laid stone. For each pattern, a ratio of quantity is provided, which will guide you in estimating the overall material required for a given project.

1-row pattern | Laying patterns

The single row model shows two examples combination. Each combination is 2.4 m (7.87") long and 180 mm (7 1/16") high. **This model can be used for installing the last row of modules or where other models cannot be used.**

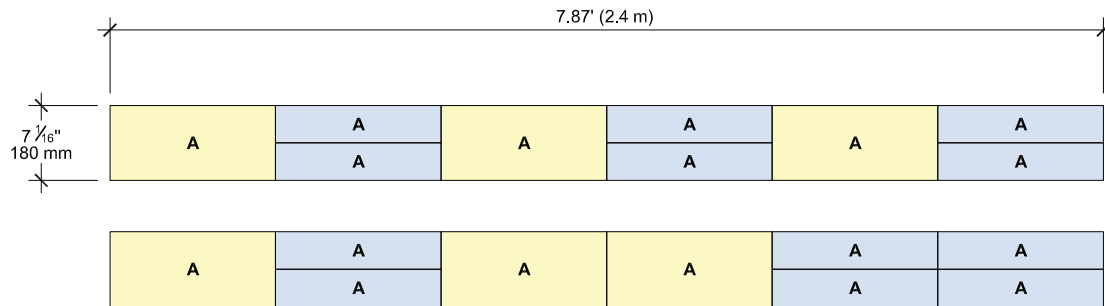

NUMBER OF BLOCKS REQUIRED	MODULE
RAFFINATO	A
50 % of the surface - Raffinato 90 mm	6
50 % of the surface - Raffinato 180 mm	3

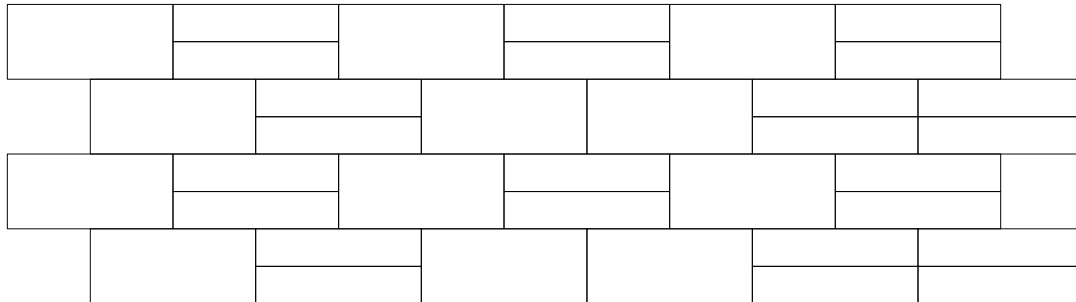

Installation guide

RETAINING WALLS - RAFFINATO 90 MM & 180 MM

3-row pattern | Laying patterns

The 3-row model is 2.4 m (7.87') long and 540 mm (21 1/4") high. This model allows for a graded area at every 540 mm (21 1/4"), which corresponds to the recommended spacing between the layers of geogrid in a Raffinato wall. **This model is recommended when using geogrid.**

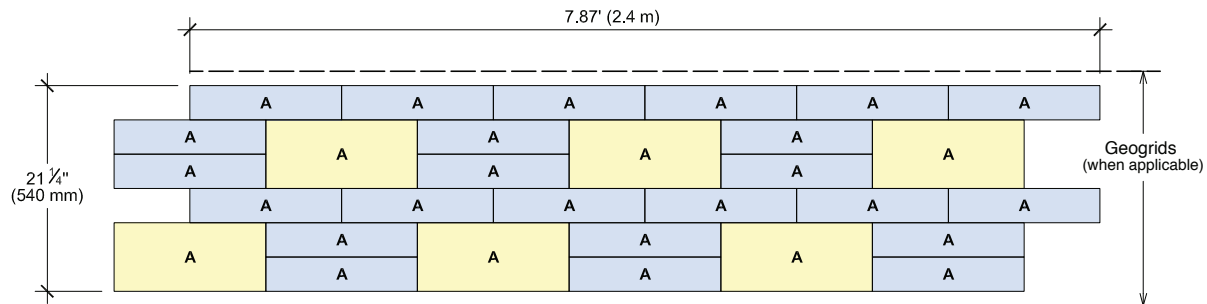

NUMBER OF BLOCKS REQUIRED	MODULE
RAFFINATO	A
67 % of the surface - Raffinato 90 mm	24
33 % of the surface - Raffinato 180 mm	6

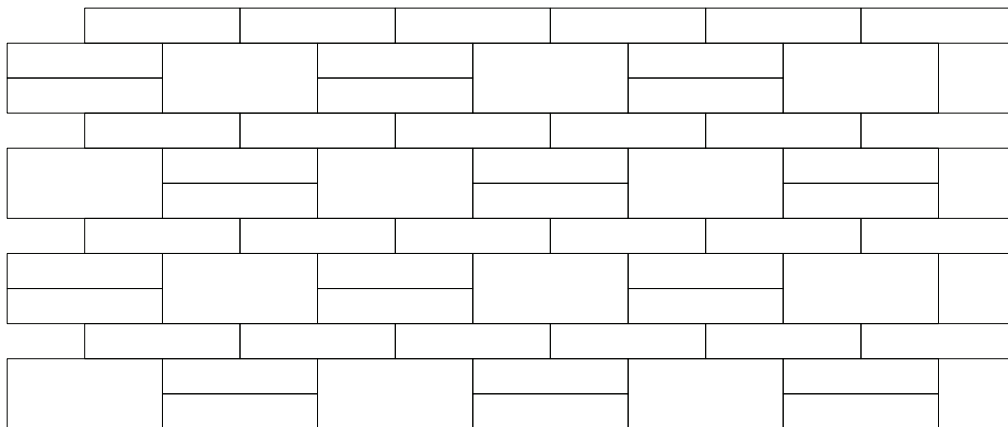

Installation guide

RETAINING WALLS - RAFFINATO 90 MM & 180 MM

4-row pattern | Laying patterns

The 4-row model shows two combination examples. This combination is 2.4 m (7,87') long and 720 mm (28 3/8") high. **This model should only be used where geogrid is not required.**

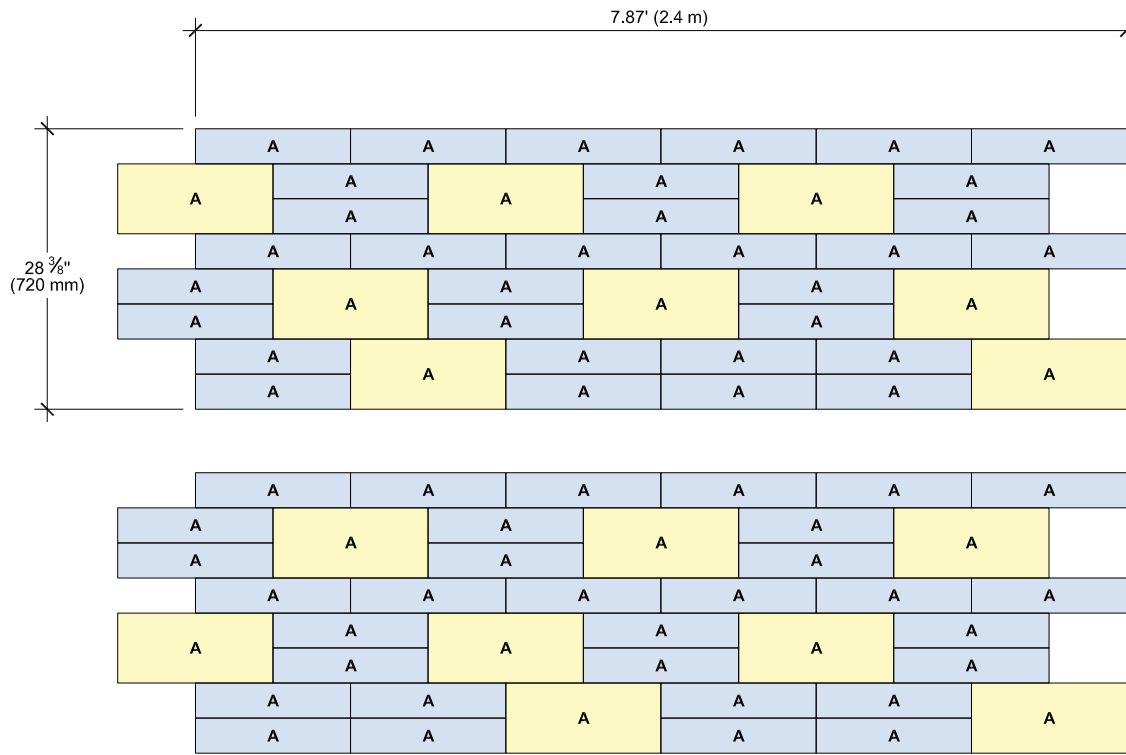

NUMBER OF BLOCKS REQUIRED	MODULE
RAFFINATO	A
67 % of the surface - Raffinato 90 mm	32
33 % of the surface - Raffinato 180 mm	8

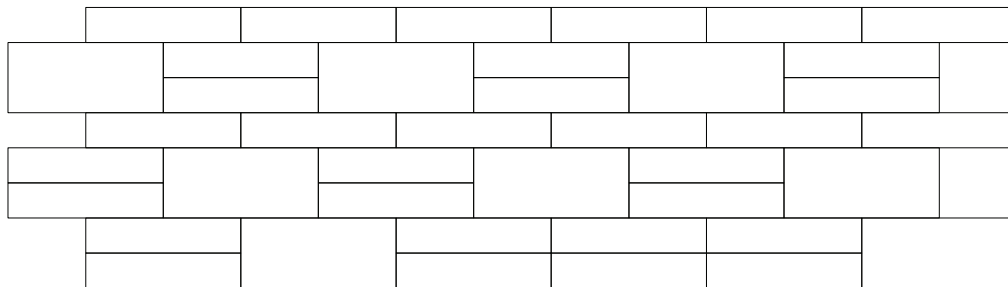

Installation guide

FREESTANDING WALLS - RAFFINATO 90 MM & 180 MM

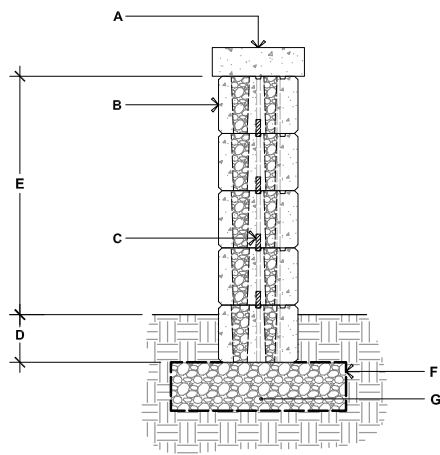

RAFFINATO 90 mm & 180 mm

- A.** TECO-BLOC CAP UNIT SECURED TO UNIT BELOW WITH CONCRETE ADHESIVE
- B.** RAFFINATO 90 mm AND 180 mm DOUBLE-SIDED WALL UNITS SECURE EACH ROW WITH CONCRETE ADHESIVE
- C.** CONNECTOR
- D.** EMBEDMENT DEPTH, 6" (150 mm) MIN.
- E.** 29 ⁷/₁₆" (750 mm) MAX.
- F.** GEOTEXTILE
- G.** COMPACTED GRANULAR LEVELING PAD, 12" (300 mm) THICK MIN. THICKNESS ACCORDING TO PROJECT SPECIFIC CONDITIONS

90° CORNER OF A DOUBLE-SIDED WALL

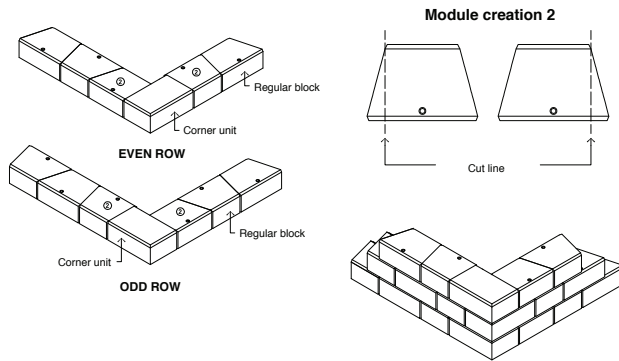

DOUBLE-SIDED WALL RADIUS

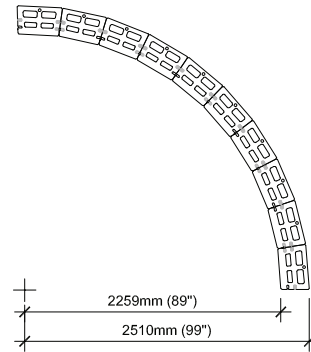

It is the user's responsibility to verify for the quantity of materials required.

DOUBLE-SIDED WALL - END OF A STRAIGHT WALL

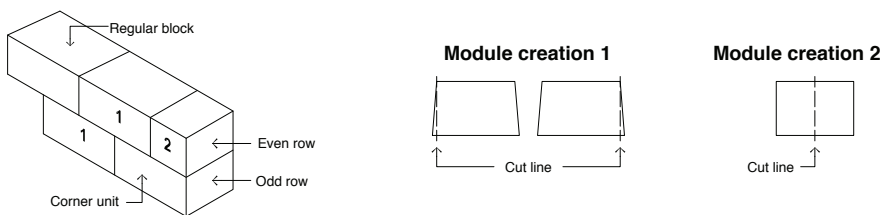

GENERAL NOTES

1. Alternate odd and even rows.
2. Stagger joints from one row to the next.
3. Glue all modules at each row with a concrete adhesive.
4. Cavities, grooves and connectors are not illustrated to avoid overloading the image.

Installation guide

PILLARS - RAFFINATO 90 MM & 180 MM

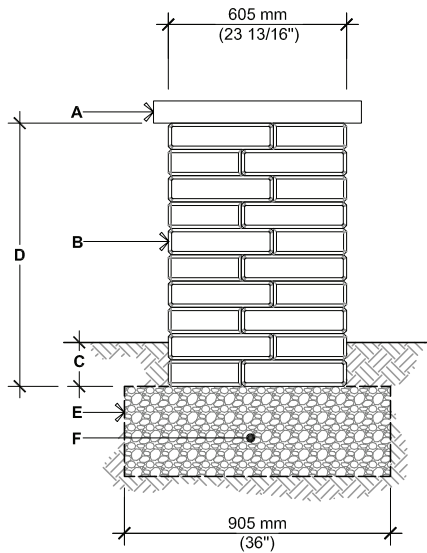

RAFFINATO 90 mm

- A. STONEDGE COLLECTION PILLAR CAP UNIT, SECURE TO UNITS BELOW WITH A CONCRETE ADHESIVE
- B. RAFFINATO 90 mm PILLAR UNIT SECURE EACH ROW WITH CONCRETE ADHESIVE
- C. EMBEDMENT DEPTH: 150 mm (6") MIN.
- D. 900 mm (35 7/16"), HEIGHT PER PALLET 1080 mm (42 1/2"), MAXIMUM HEIGHT
- E. GEOTEXTILE
- F. COMPACTED GRANULAR BASE 150 mm (6") THICK MIN. THICKNESS ACCORDING TO PROJECT SPECIFIC CONDITIONS

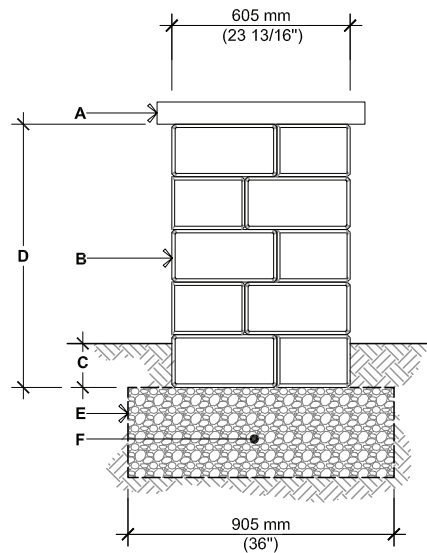

RAFFINATO 180 mm

- A. STONEDGE COLLECTION PILLAR CAP UNIT, SECURE TO UNITS BELOW WITH A CONCRETE ADHESIVE
- B. RAFFINATO 180 mm PILLAR UNIT SECURE EACH ROW WITH CONCRETE ADHESIVE
- C. EMBEDMENT DEPTH: 150 mm (6") MIN.
- D. 900 mm (35 7/16"), HEIGHT PER PALLET 1080 mm (42 1/2"), MAXIMUM HEIGHT
- E. GEOTEXTILE
- F. COMPACTED GRANULAR BASE 150 mm (6") THICK MIN. THICKNESS ACCORDING TO PROJECT SPECIFIC CONDITIONS

For all possible combinations of pillars and caps, please refer to the correspondence table on page 99.

Installation guide

PILLARS - RAFFINATO 90 MM & 180 MM

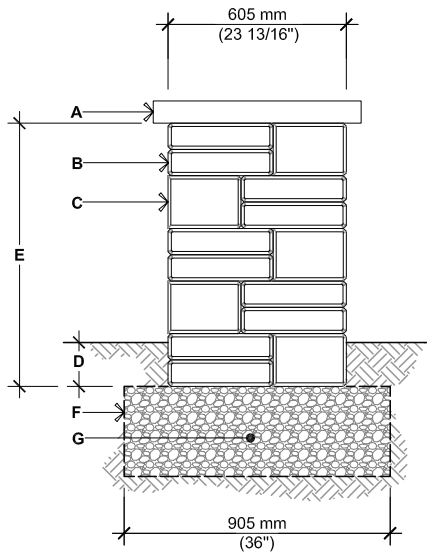

○ RAFFINATO 90 mm & 180 mm
OPTION A

- A.** STONEDGE COLLECTION PILLAR CAP UNIT, SECURE TO UNITS BELOW WITH A CONCRETE ADHESIVE
- B.** RAFFINATO 90 mm PILLAR UNIT SECURE EACH ROW WITH CONCRETE ADHESIVE
- C.** RAFFINATO 180 mm PILLAR UNIT SECURE EACH ROW WITH CONCRETE ADHESIVE
- D.** EMBEDMENT DEPTH: 150 mm (6") MIN.
- E.** 900 mm (35 7/16"), 1080 mm (42 1/2"), MAXIMUM HEIGHT
- F.** GEOTEXTILE
- G.** COMPACTED GRANULAR BASE 150 mm (6") THICK MIN. THICKNESS ACCORDING TO PROJECT SPECIFIC CONDITIONS

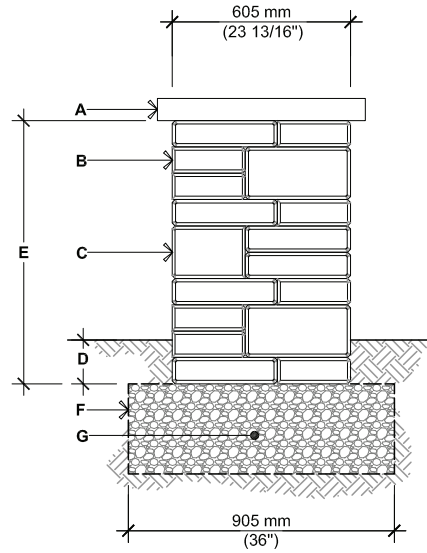

○ RAFFINATO 90 mm & 180 mm
OPTION B

- A.** STONEDGE COLLECTION PILLAR CAP UNIT, SECURE TO UNITS BELOW WITH A CONCRETE ADHESIVE
- B.** RAFFINATO 90 mm PILLAR UNIT SECURE EACH ROW WITH CONCRETE ADHESIVE
- C.** RAFFINATO 180 mm PILLAR UNIT SECURE EACH ROW WITH CONCRETE ADHESIVE
- D.** EMBEDMENT DEPTH: 150 mm (6") MIN.
- E.** 900 mm (35 7/16"), 1080 mm (42 1/2"), MAXIMUM HEIGHT
- F.** GEOTEXTILE
- G.** COMPACTED GRANULAR BASE 150 mm (6") THICK MIN. THICKNESS ACCORDING TO PROJECT SPECIFIC CONDITIONS

STEPS

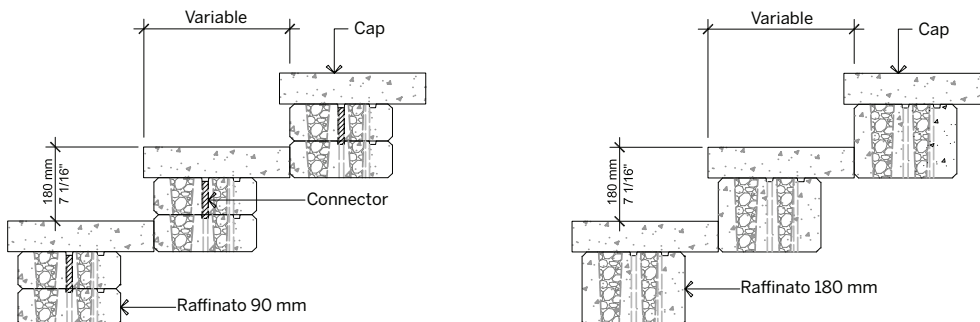

For all possible combinations of walls, pillars and caps, please refer to the correspondence table on page 99.

Installation guide

FREESTANDING WALLS - RÖCKA

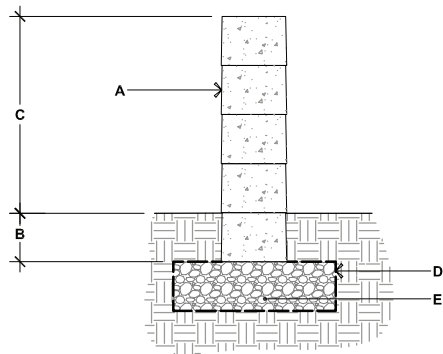

RÖCKA

- A. RÖCKA DOUBLE-SIDED WALL UNITS SECURE EACH ROW WITH CONCRETE ADHESIVE
- B. EMBEDMENT DEPTH, 6" (150 mm) MIN.
- C. 24" (612 mm) MAX.
- D. GEOTEXTILE
- E. COMPACTED GRANULAR LEVELING PAD, 12" (300 mm) THICK MIN. THICKNESS ACCORDING TO PROJECT SPECIFIC CONDITIONS

90° CORNER OF A DOUBLE-SIDED WALL

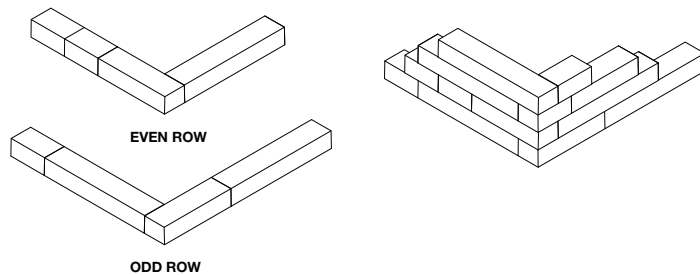

1. Alternate odd and even rows
2. Stagger vertical joints by at least $\frac{1}{4}$ of the length of the block.
3. Glue all modules at each row with a concrete adhesive.
4. It is possible to alternate the blocks (A, B or C) in the same row to create different patterns.

DOUBLE-SIDED WALL - END OF A STRAIGHT WALL

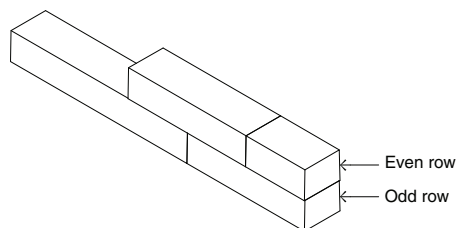

* It is possible to alternate the blocks (A, B or C) in the same row to create different patterns. However, a minimum distance of $\frac{1}{4}$ the length of the block is required between the vertical joints.

Installation guide

RETAINING WALL DESIGN CHART - SEMMA

The information contained in the design charts is supplied for information purposes only. Techo-Bloc and its predecessors, successors, beneficiaries, employees, associates, administrators and insurers can not under any circumstances be held liable for the incorrect use of information contained in design charts. **This chart should be read in conjunction with the notes on page 103.**

CASE N° 1

Inclined wall (7.6°)
Surcharge: 6 kPa

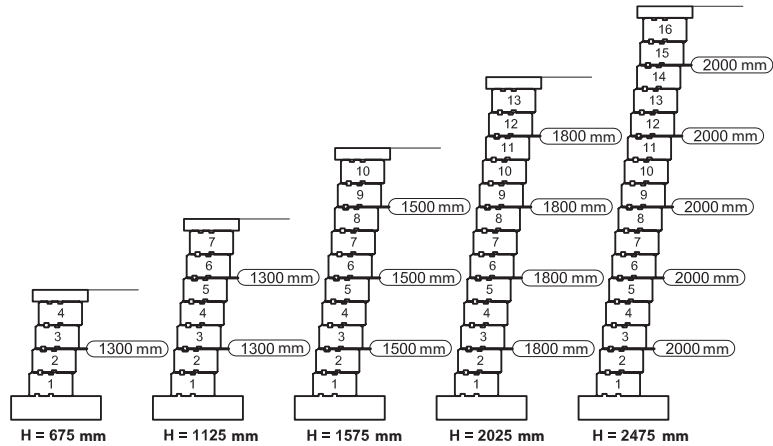
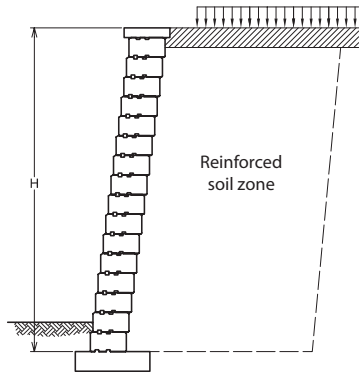

CASE N° 2

Inclined wall (7.6°)
Slope: 1V:3H

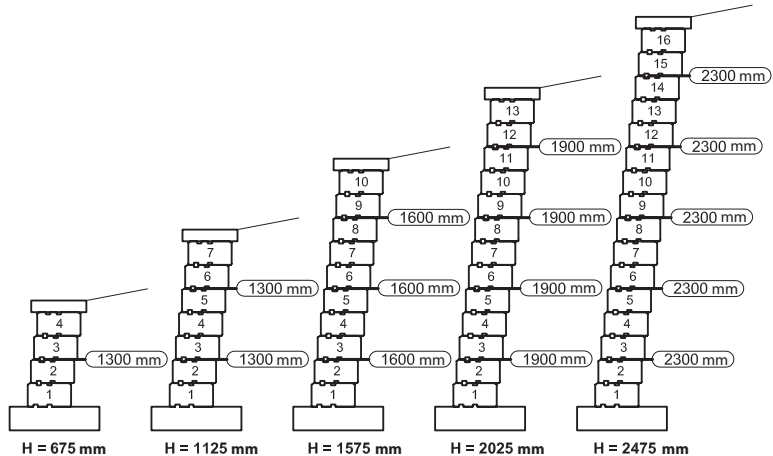
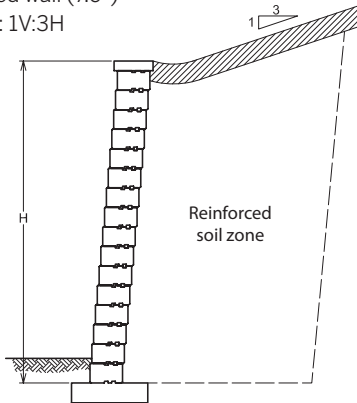

THE DESIGN CHARTS WERE DEVELOPED BASED ON THE FOLLOWING CONDITIONS:

- Geogrid layout determined as per the requirements of the "Design Manual for Segmental Retaining Walls, 3rd Edition" from the National Concrete Masonry Association.
- Geogrid type Miragrid® 3XT from Tencate Mirafi.
- Soil parameters: reinforced soil ($\phi = 36^\circ$, $\gamma = 21 \text{ kN/m}^3$); retained soil ($\phi = 28^\circ$, $\gamma = 20 \text{ kN/m}^3$); foundation soil ($\phi = 28^\circ$, $\gamma = 19 \text{ kN/m}^3$).
- The bearing capacity of the soil, settlement, and global stability must be verified and validated by a qualified geotechnical engineer.
- The seismic analysis was not considered.
- The hydrostatic pressure is not considered. The wall must be provided with an adequate drainage system.
- 6 kPa (125 psf) surcharge (cars and light trucks).
- The design charts do not apply to tiered walls.

For further information, please contact our technical service department.

Email: WALLS@TECHO-BLOC.COM Web site: WWW.TECHO-BLOC.COM

Installation guide

FREESTANDING WALLS - SEMMA

SEMMA

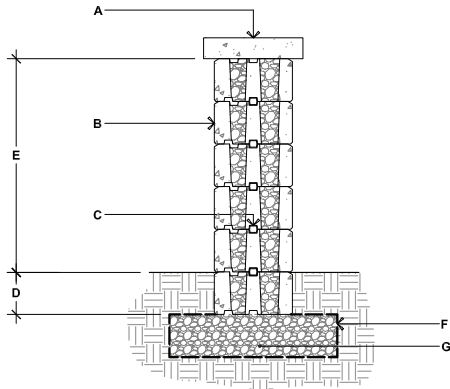

- A.** TECO-BLOC CAP UNIT SECURED TO UNIT BELOW WITH CONCRETE ADHESIVE
- B.** SEMMA DOUBLE-SIDED WALL UNIT SECURE EACH ROW WITH CONCRETE ADHESIVE
- C.** CONNECTOR
- D.** EMBEDMENT DEPTH, 6" (150 mm) MIN.
- E.** 29 7/16" (750 mm) MAX.
- F.** GEOTEXTILE
- G.** COMPACTED GRANULAR LEVELING PAD, 12" (300 mm) THICK MIN. THICKNESS ACCORDING TO PROJECT SPECIFIC CONDITIONS

90° CORNER OF A DOUBLE-SIDED WALL

DOUBLE-SIDED WALL RADIUS

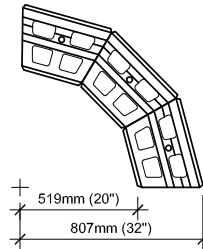
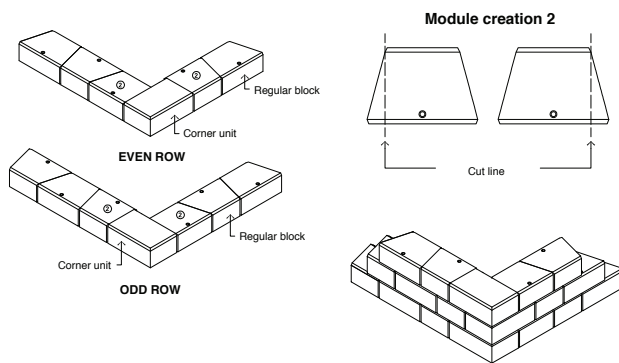

It is the user's responsibility to verify for the quantity of materials required.

DOUBLE-SIDED WALL - END OF A STRAIGHT WALL

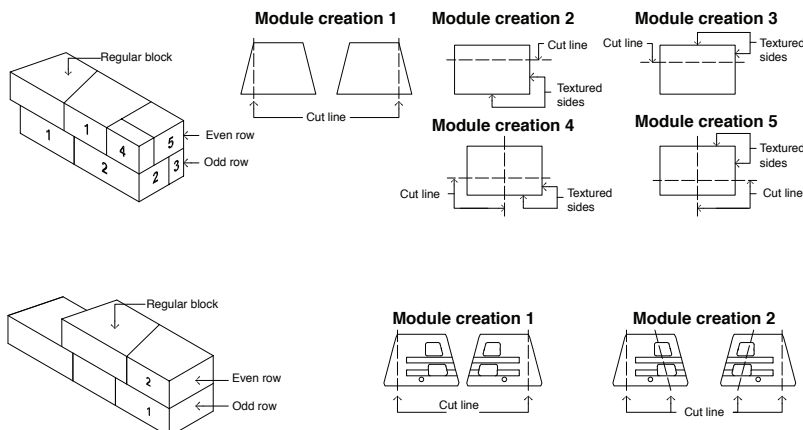

GENERAL NOTES

1. Alternate odd and even rows.
2. Stagger joints from one row to the next.
3. Glue all modules at each row with a concrete adhesive.
4. Cavities, grooves and connectors are not illustrated to avoid overloading the image.

Installation guide

PILLARS - SEMMA

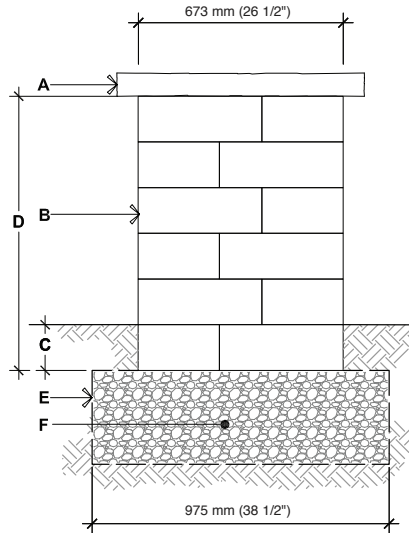

SEMMA

- A. PILLAR CAP UNIT
(SECURE WITH CONCRETE ADHESIVE)
- B. SEMMA PILLAR UNIT SECURE EACH ROW
WITH CONCRETE ADHESIVE
- C. EMBEDMENT 6" (150 mm) MIN.
- D. 35 $\frac{7}{16}$ " (900 mm), HEIGHT PER PALLET
47 $\frac{1}{4}$ " (1200 mm), MAXIMUM HEIGHT
- E. GEOTEXTILE
- F. COMPACTED GRANULAR BASE 6" (150mm)
THICK MIN. THICKNESS ACCORDING TO
PROJECT SPECIFIC CONDITIONS

For all possible combinations of pillars and caps, please refer to the correspondence table on page 99.

STEPS

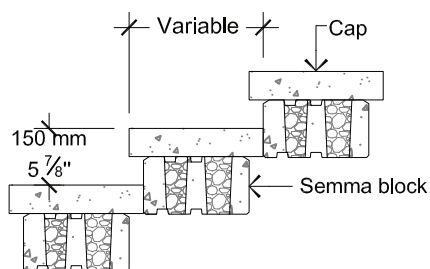

For all possible combinations of walls and caps, please refer to the correspondence table on page 99.

Installation guide

RETAINING WALL DESIGN CHART - SUPREMA

The information contained in the design charts is supplied for information purposes only. Techo-Bloc and its predecessors, successors, beneficiaries, employees, associates, administrators and insurers can not under any circumstances be held liable for the incorrect use of information contained in design charts. **This chart should be read in conjunction with the notes on page 103.**

CASE N° 1

Inclined wall (4.5°)
Surcharge: 6 kPa

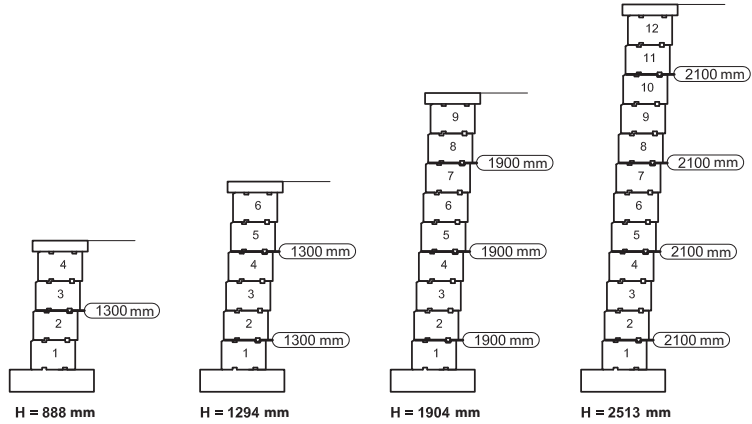
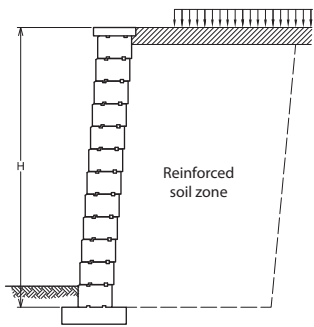

CASE N° 2

Inclined wall (4.5°)
Slope: 1V:3H

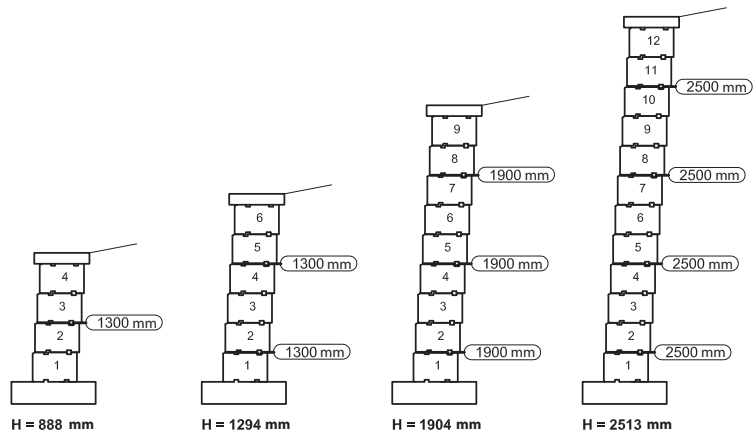
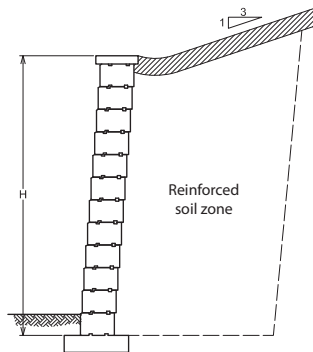

THE DESIGN CHARTS WERE DEVELOPED BASED ON THE FOLLOWING CONDITIONS:

- Geogrid layout determined as per the requirements of the "Design Manual for Segmental Retaining Walls, 3rd Edition" from the National Concrete Masonry Association.
- Geogrid type Miragrid® 3XT from Tencate Mirafi.
- Soil parameters: reinforced soil ($\phi = 36^\circ$, $\gamma = 21 \text{ kN/m}^3$); retained soil ($\phi = 28^\circ$, $\gamma = 20 \text{ kN/m}^3$); foundation soil ($\phi = 28^\circ$, $\gamma = 19 \text{ kN/m}^3$).
- The bearing capacity of the soil, settlement, and global stability must be verified and validated by a qualified geotechnical engineer.
- The seismic analysis was not considered.
- The hydrostatic pressure is not considered. The wall must be provided with an adequate drainage system.
- 6 kPa (125 psf) surcharge (cars and light trucks).
- The design charts do not apply to tiered walls.

For further information, please contact our technical service department.

Email: WALLS@TECHO-BLOC.COM Web site: WWW.TECHO-BLOC.COM

Installation guide

STEPS - SUPREMA

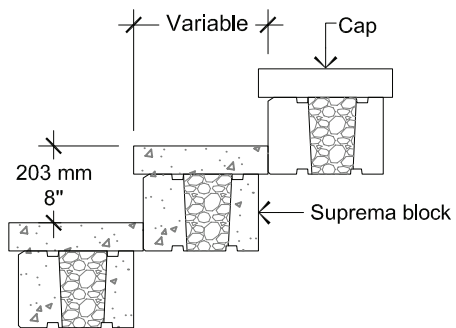

For all possible combinations of walls and caps, please refer to the correspondence table on page 99.